



Tarifa de precios 30/15

Válvula de esfera Ø140. PASO TOTAL

Especialmente diseñada
para el sector agroalimentario



Válvula de esfera Ø140, PASO TOTAL

NUEVO

Nueva válvula de Ø140 mm (DN 125) de PASO TOTAL.

Especialmente diseñada para el sector agroalimentario.

Superficie interior lisa que evita el daño de sólidos en suspensión durante el paso.



INTERIOR TOTALMENTE LISO

PN6 - Diámetro de paso 125 mm (correspondiente al de una tubería de PVC de Ø140 mm y PN10)

Aplicaciones: Riego, industria agroalimentaria, piscicultura (almazaras, bodegas, conservas...).

- Mínima pérdida de carga.
- No existe estrechamiento en su paso por la bola, lo que evita obturaciones y permite el paso de productos sólidos. Esta cualidad la hace idónea para la industria agroalimentaria.
- Toma de engrase M5 para lubricación de la bola.

Pérdida de carga a 20°C

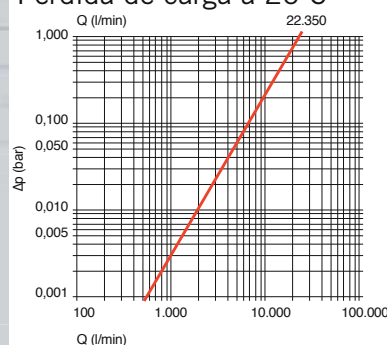

Válvula de esfera Ø140 mm - PASO TOTAL

Brida, PASO TOTAL

Medida	D.N.	Ref.	u./	nº	€
140 P.T.	125	52322	1	A-9	511,56



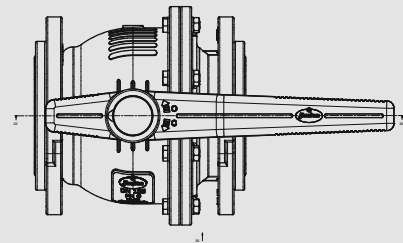
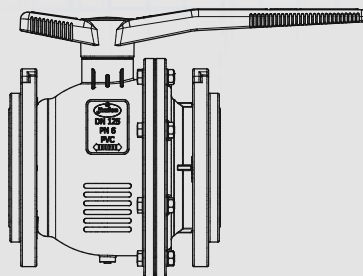
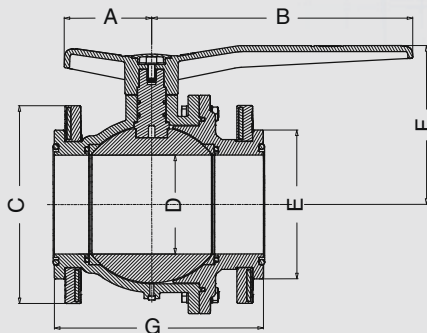
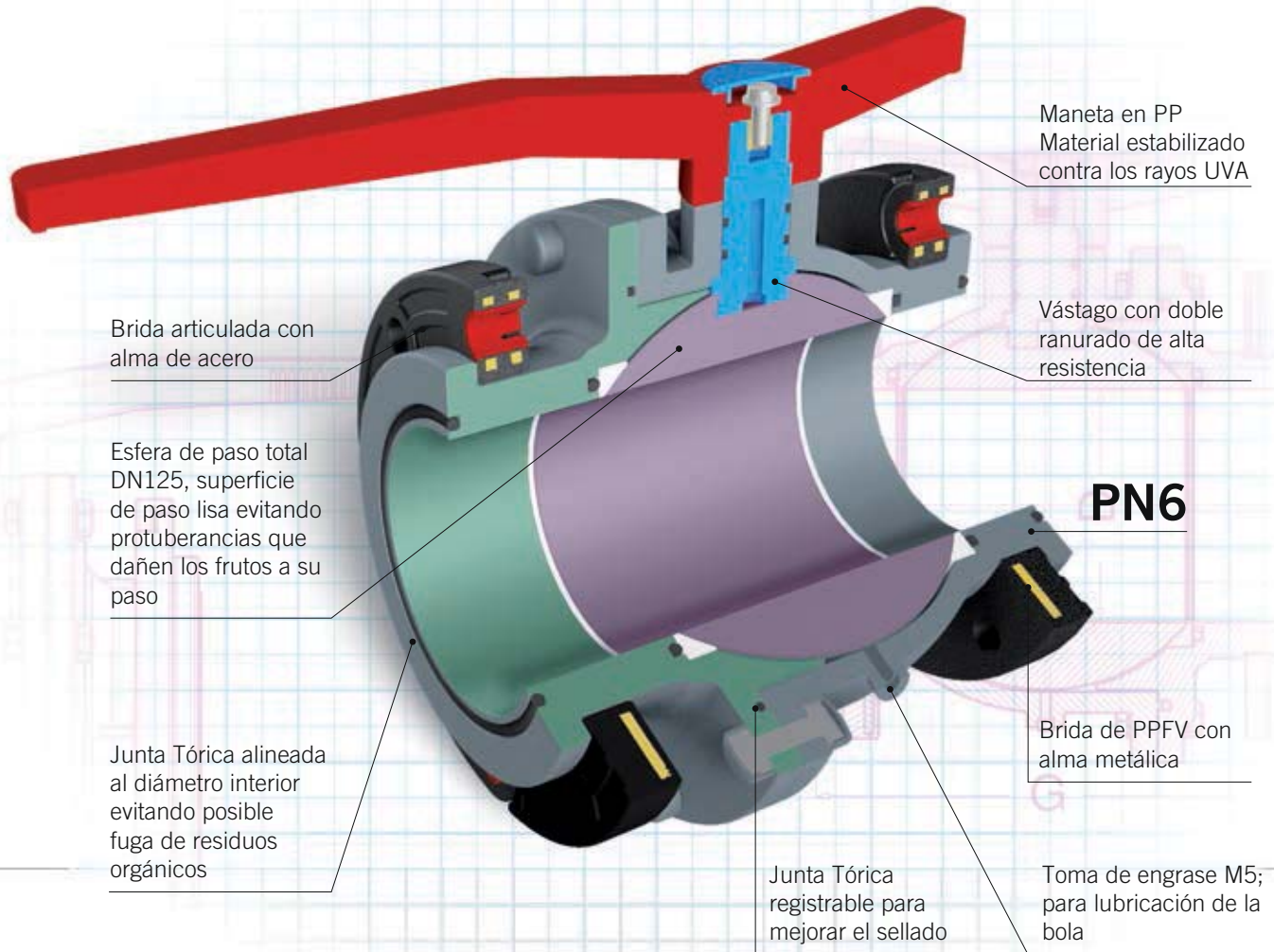

Dimensiones (en mm)

Medida	A	B	C	D	E	F	G
140 P.T.	110	330	250	125	188	200,5	264



Accesorios válvula de esfera Ø140 - PASO TOTAL



Brida articulada Ø140 mm

Medida	D.N.	Ref.	u./	nº	€
140	-	52323	1	-	156,00



Adaptadores actuador (*) Incluye tornillos

Medida	D.N.	Ref.	u./	nº	€
140	-	60019	1	-	115,00



Portabrida válvula Ø140 mm

Medida	D.N.	Ref.	u./	nº	€
140	-	52324	1	-	27,82



Kit del eje actuador

Medida	D.N.	Ref.	u./	nº	€
-	-	60022	1	-	43,55



Portabrida reducido válvula Ø160 mm

Medida	D.N.	Ref.	u./	nº	€
160	-	52325	1	-	31,55



(*) Incluye tornillo

Conjunto maneta válvula Ø140 mm

Medida	D.N.	Ref.	u./	nº	€
140	-	52326	1	-	25,84



Repuesto de juntas tóricas (EPDM)

Medida	D.N.	Ref.	u./	nº	€
140	-	52327	1	-	27,33



Actuador eléctrico

Voltaje	D.N.	Ref.	u./	nº	€
220V	-	60020	1	-	1325,76





Actuador neumático doble efecto

Voltaje	D.N.	Ref.	u./	nº	€
24V	-	60021	1	-	572,68

Válvulas de esfera desmontables en PVC/PP Grandes diámetros (Ø 75/90/110/125)



Encolar

Medida	D.N.	Ref.	u./ 	nº 	€
75*	65	52207	4	A-8	136,46
**90*	65	52319	1	A-2	143,34
90*	80	52208	3	A-8	149,45
**110*	80	52320	1	A-2	168,24
110*	100	52209	2	A-9	272,89
**125*	100	52297	2	A-9	327,13



**Paso reducido

125*	113	52306	1	A-11	352,32
------	-----	-------	---	------	--------

Paso Total





Rosca hembra

Medida	D.N.	Ref.	u./ 	nº 	€
2 ½"	65	52240	4	A-8	144,03





Rosca macho

Medida	D.N.	Ref.	u./ 	nº 	€
2 ½"	65	52267	4	A-9	144,03
3"	80	52268	3	A-9	171,01





Cuerpo central

Medida	D.N.	Ref.	u./ 	nº 	€
75 - 2 ½"	65	52507	4	A-11	83,39
90 - 3"	80	52508	4	A-8	90,96
110 - 4"	100	52509	4	A-4	181,44
125 P.T.	113	52609	4	A-4	274,39





Enlace tubo polietileno

Medida	D.N.	Ref.	u./ 	nº 	€
75*	65	52287	4	A-4	159,20
90*	80	52288	3	A-12	171,01



Brida

Medida	D.N.	Ref.	u./ 	nº 	€
75*	65	52291	4	A-9	159,20
90*	80	52292	3	A-4	171,01

* El cuerpo está fabricado en PP (polipropileno) en las medidas de 75, 90, 110, 125, 2 ½" y 3"



Válvula de esfera Ø140 - PASO TOTAL

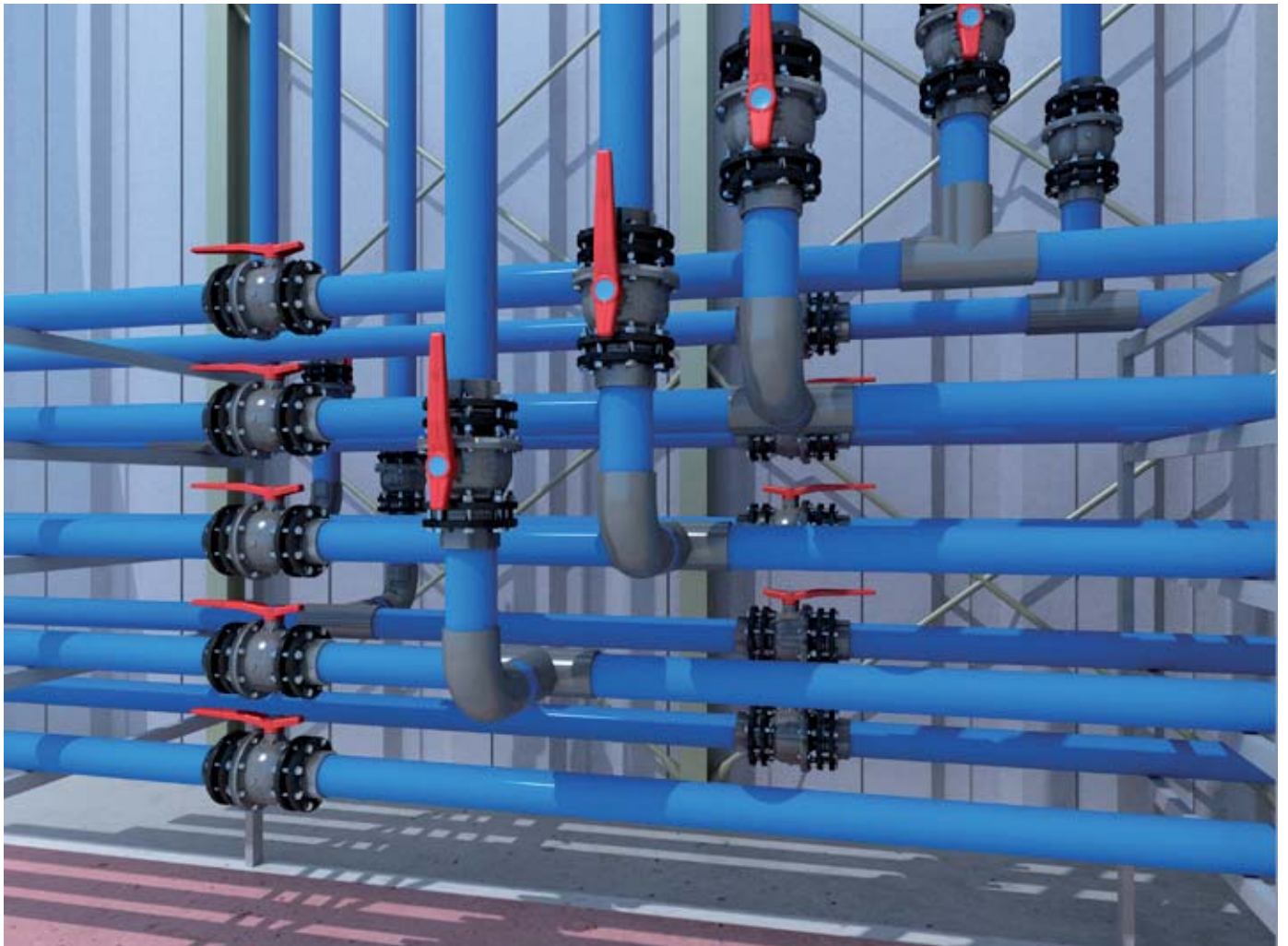

©JIMTEN 15M

45355 103-16

jimten, SA
CTRA. DE OCAÑA, 125 C.P. 03114
✉ 5285 C.P. 03080
☎ + 34.965.10.90.44
Fax. + 34.965.11.50.82
ALICANTE (ESPAÑA)
www.jimten.com



ER-0084/1996



GA-1999/0156

an *OAliaxis* company