



Infraestructura e Industria

Tarifa 2023

Enero 2023





Los tres últimos años: 2020, 2021 y 2022, han estado marcados por dos elementos que han sido determinantes en la economía global y también en nuestro mercado en particular: la volatilidad y la incertidumbre y no parece que en 2023 vayan a desaparecer, sino que seguirán marcando, para bien o para mal la evolución de nuestros negocios y de nuestras vidas.

En Aliaxis hemos incorporado esta situación a nuestra manera de entender el negocio y por eso, 2023 continúa de manera coherente con las decisiones estratégicas tomadas en 2022 y con anterioridad.

Seguimos apostando por los pilares clave de nuestra estrategia; **SEGURIDAD, SOSTENIBILIDAD, EXCELENCIA COMERCIAL y EXCELENCIA OPERACIONAL**, todo ello basado en atraer y mantener **el mejor talento**, por eso estamos orgullosos de nuestra gente, de nuestros equipos, que son quienes marcan la diferencia, no solo por lo que hacen y por su conocimiento, sino sobre todo, por cómo lo hacen, por cómo somos.

Ante la incertidumbre, certidumbre; seguimos apostando por la inversión estructural y en 2023 haremos notables inversiones en proyectos clave, siempre basados en los pilares de nuestra estrategia antes mencionados, y superando las ya hechas en 2022. Ante la volatilidad, flexibilidad y adaptabilidad, siempre hemos sido de los primeros, si no los primeros, en reaccionar ante las circunstancias del mercado, a veces asumiendo riesgos y con valentía, pero al final siempre el mercado ha tenido que reaccionar también, nosotros a eso le llamamos **honestidad y valor**, (que son dos de nuestros valores esenciales).

Esta tarifa de 2023 es una nueva apuesta honesta y valiente para tratar de dar a nuestros clientes certeza y flexibilidad en momentos inciertos y volátiles.

Desde Aliaxis Iberia, ofrecemos lo mejor de nosotros, que se traslada a los mejores productos del mercado, pero, sobre todo, se vive a través de las relaciones sólidas, honestas y basadas en ganar-ganar para todas las partes. Por eso, esta tarifa es algo más que una tarifa, es la punta de lanza de una empresa con fuertes valores, con compromisos sólidos con su gente y con sus clientes, y que sigue invirtiendo y liderando desde la honestidad.

Por todo ello, me atrevo a afirmar, con **humildad**, (que es otro de nuestros valores esenciales), pero con convencimiento, que somos un socio y un aliado confiable y sólido en cualquier circunstancia.

Deseo que 2023 sea un año bueno para todos y que nos devuelva a la senda del crecimiento sostenible, y que nos haga mejores y más resilientes.

Un afectuoso saludo,

Jorge Barranco
Vicepresidente Aliaxis Iberia

Índice

Infraestructura

1 Tubería de PE	7	
Tubería para agua	8	
Flexipol PE100 / FM / RD / RC / RT		
Flexipol PE100 ranurado/perforado		
Excel-Plus		
Tubería para gas	15	
Gasypol PE100 RC		
2 Magnum 3G	17	
Fitting para tubo de PE	18	
Fitting con inserto de latón	23	
Fitting UTC/PE	24	
Fitting alta resistencia química HCR	26	
Válvulas para contador HCR	28	
Repuestos	29	
3 Accesorios manipulados de PE	31	
4 Bridas, portabridas, pasamuros y juntas	41	
5 Accesorios electrosoldables Frialen	49	
Accesorios electrosoldables PE		
Tomas simples		
Tomas en carga		
Válvulas PE para agua y gas		
6 Equipos y herramientas Friatools	67	
Máquinas de soldadura		
Rascadores		
Accesorios y herramientas		
7 Accesorios de PE inyectados largos	81	
8 Accesorios de PE inyectados cortos	91	
9 Accesorios metálicos	99	
Uniones y adaptadores brida		
Carretes de desmontaje		
Abrazaderas de reparación		
10 Válvulas y accesorios de fundición	117	
Válvulas		
Trampillones		
Accesorios		
Ventosas		
Hidrantes y bocas de riego		
Collarines, abrazaderas, tomas en carga		
Bridas		
11 Accesorios para saneamiento enterrado PVC	133	

Industria

12 Tubería de PVC-U presión	139	17 Sistema PP-H socket	281
		Tubo y accesorios	284
13 Accesorios de PVC-U presión	141	Válvulas manuales	288
Accesorios encolados, mixtos y roscados		Válvulas actuadas	297
Bridas y adaptadores		Válvulas de control de presión	313
Uniones 3 piezas		18 Sistema PP-H testa/butt welding	315
Soportes y abrazaderas		Accesorios	318
Adhesivos y disolventes		19 Sistema PVDF	327
14 Válvulas manuales de PVC-U presión	161	Tubo y accesorios	330
Válvulas de bola 2 vías	170	Válvulas manuales	332
Válvulas de bola 3 vías	175	Válvulas actuadas	339
Válvulas de mariposa	176	Válvulas de control de presión	348
Válvulas y grifos de membrana	179	20 Sistema C-PVC	351
Válvulas de retención	182	Tubo y accesorios	354
Conectores	185	Válvulas manuales	358
Filtros inclinados	186	Válvulas actuadas	365
Accesorios para válvulas manuales	188	21 Accesorios mecánicos para la unión de tuberías - Straub	379
15 Válvulas motorizadas de PVC-U presión	191	22 Recambios	431
Válvulas de solenoide	194		
Válvulas de bola actuadas	197		
Válvulas de 3 vías actuadas	201		
Válvulas de mariposa	204		
Actuadores y accesorios	210		
Válvulas de membrana	214		
Accesorios válvulas de membrana	220		
Válvulas de control de presión	224		
16 Medición	225		
Flujómetros modelo corto	228		
Flujómetros modelo largo	245		
Medidores electrónicos de caudal	263		
Sensores de caudal	266		
Electrodos de PH y ORP	270		
Sensores y transmisores de conductividad	272		
Accesorios de instalación y recambios	274		

1
2
3
4
5
6
7
8
9
10
11
12
13
14
15
16
17
18
19
20
21
22



Tubería para agua

Flexipol PE100 / FM / RD / RC / RT
Flexipol PE100 ranurado/perforado
Excel-Plus®

Tubería para gas

Gasypol PE100 RC

Tubería para telecomunicaciones y alta tensión

Tubería de Polietileno

INFRAESTRUCTURA





INFRAESTRUCTURA

Tubería de Polietileno para agua

Flexipol PE100 / FM / RD / RC / RT



FLEXIPOL - MASA TUBOS DE POLIETILENO PE100

Conducción de Agua a Presión
Fabricados según Norma UNE-EN 12201

COLOR Y APLICACIONES

Negro Banda Azul: Agua Potable
Negro-Negro Banda Marrón: Agua no Potable (Aguas Industriales-Saneamiento)
Negro Banda Morada: Agua no Potable (Agua Reciclada)

MARCAJE:

MASA FLEXIPOL

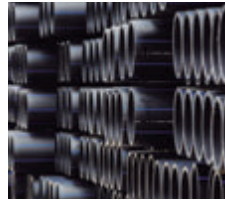

Declaración de cumplimiento Hessel con la PAS 1075 disponible.

FORMATO DE SUMINISTROS*:

Hasta Ø 90 en rollos de 100 metros
Ø 110 en rollos de 50 metros y 100 metros
Desde Ø 20 hasta Ø 110 barras de 6 metros
Desde Ø 90 hasta Ø280 en barras de 12 metros
Desde Ø 315 hasta Ø 1000 en barras de 13 metros

Ref.	Ø Ext.	PN	Long.	Presentacion	Barras / Palet	€/m
060020016125	20	16	100	Rollo	-	0,79
060025016125	25	16	100	Rollo	-	0,96
059032010125	32	10	100	Rollo	-	1,05
060032016125	32	16	100	Rollo	-	1,51
059040010125	40	10	100	Rollo	-	1,72
060040016125	40	16	100	Rollo	-	2,51
060040016116	40	16	6	Barra	100	2,51
059050010125	50	10	100	Rollo	-	2,57
060050016125	50	16	100	Rollo	-	3,79
060050016116	50	16	6	Barra	80	3,79
059063010125	63	10	100	Rollo	-	3,91
059063010116	63	10	6	Barra	131	3,91
060063016116	63	16	6	Barra	131	5,72
060063016125	63	16	100	Rollo	-	5,72
059075010116	75	10	6	Barra	100	6,89
059075010124	75	10	50	Rollo	-	6,89
059075010125	75	10	100	Rollo	-	6,89
060075016116	75	16	6	Barra	100	7,83
060075016125	75	16	100	Rollo	-	7,83
060075016124	75	16	50	Rollo	-	7,83
059090010116	90	10	6	Barra	63	8,98
059090010125	90	10	100	Rollo	-	8,98
059090010124	90	10	50	Rollo	-	8,98
060090016116	90	16	6	Barra	63	11,08
060090016125	90	16	100	Rollo	-	11,08
060090016124	90	16	50	Rollo	-	11,08
059110010116	110	10	6	Barra	60	13,21
059110010124	110	10	50	Rollo	-	13,21
059110010115	110	10	12	Barra	60	13,21
059110010125	110	10	100	Rollo	-	13,21
060110016116	110	16	6	Barra	43	16,30
060110016115	110	16	12	Barra	43	16,30

Ref.	Ø Ext.	PN	Long.	Presentacion	Barras / Palet	€/m
060110016125	110	16	100	Rollo	-	16,30
060110016124	110	16	50	Rollo	-	16,30
059125010116	125	10	6	Barra	45	17,25
059125010115	125	10	12	Barra	45	17,25
060125016115	125	16	12	Barra	30	20,90
060125016116	125	16	6	Barra	30	20,90
059140010115	140	10	12	Barra	39	21,80
059140010116	140	10	6	Barra	39	21,80
059160010115	160	10	12	Barra	28	22,95
059160010116	160	10	6	Barra	28	22,95
060160016116	160	16	6	Barra	17	33,92
060160016115	160	16	12	Barra	17	33,92
059180010115	180	10	12	Barra	22	34,60
059200010115	200	10	12	Barra	6	44,70
059200010116	200	10	6	Barra	6	44,70
060200016116	200	16	6	Barra	6	52,68
060200016115	200	16	12	Barra	6	52,68
060225016116	225	16	6	Barra	5	66,26
059250010115	250	10	12	Barra	5	79,29
059250010116	250	10	6	Barra	5	79,29
060250016115	250	16	12	Barra	5	81,71
060250016116	250	16	6	Barra	5	81,71
059315010113	315	10	13	Barra	4	100,19
059315010116	315	10	6	Barra	4	100,19
060315016113	315	16	13	Barra	4	130,00
060315016116	315	16	6	Barra	4	130,00
059355010113	355	10	13	Barra	3	135,26
059400010113	400	10	13	Barra	3	141,92
060400016113	400	16	13	Barra	3	209,62
059500010113	500	10	13	Barra	2	220,56
059630010113	630	10	13	Barra	2	348,31
059710010113	710	10	13	Barra	2	442,68

FLEXIPOL - MASA
TUBOS DE POLIETILENO PE100

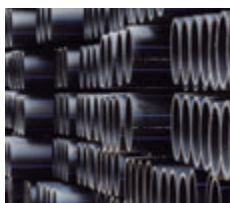

** Para Otros formatos, bandas presiones y aplicaciones se establece una cantidad mínima por pedido según la siguiente tablas*

Ø Medida	Cantidad mínima
	por pedido (m)
20	20000
25	15000
32	10000
40	5000
50	4000
63	2500
75	1500
90	1000
110	1000
125	800
140	500
160	600
180	500
200	400
225	450
250	400
280	450
315	200
355	200
400	150
450	200
500	150
560	200
630	150
710	150
800	100
900	100
1000	100

Ø Medida	C X PALET AGUA	
	PN 10	PN 16
20		250 (metro)
25		200 (metro)
32	150 (metro)	150 (metro)
40	100 (barra)	100 (barra)
50	80 (barra)	80 (barra)
63	131 (barra)	131 (barra)
75	100 (barra)	100 (barra)
90	63 (barra)	63 (barra)
110	60 (barra)	43 (barra)
125	45 (barra)	30 (barra)
140	39 (barra)	26 (barra)
160	28 (barra)	17 (barra)
180	22 (barra)	17 (barra)
200	6 (barra)	6 (barra)
225	5 (barra)	5 (barra)
250	5 (barra)	5 (barra)
280	4 (barra)	4 (barra)
315	4 (barra)	4 (barra)
355	3 (barra)	3 (barra)
400	3 (barra)	3 (barra)
450	2 (barra)	2 (barra)
500	2 (barra)	2 (barra)
560	2 (barra)	2 (barra)
630	2 (barra)	2 (barra)
710	2 (barra)	2 (barra)
800	2 (barra)	2 (barra)
900	1 (barra)	1 (barra)
1000	1 (barra)	1 (barra)

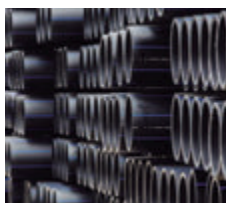
FLEXIPOL - MASA
TUBOS DE POLIETILENO FM

Declaración de cumplimiento Hessel con la PAS 1075 disponible.

Ref.	Ø	PN	SDR	Longitud barra (m)	Color tubo	PVP
A1F0900121F0	90	16	11	12	NEGRO SIN BANDA	18,12
A1F1100121F0	110	16	11	12	NEGRO SIN BANDA	26,88
A1F1600121F0	160	16	11	12	NEGRO SIN BANDA	57,03
A1F2000121F0	200	16	11	12	NEGRO SIN BANDA	88,91
A1F2250121F0	225	16	11	12	NEGRO SIN BANDA	110,06
A1F2500121F0	250	16	11	12	NEGRO SIN BANDA	138,40
A1F2800121F0	280	16	11	12	NEGRO SIN BANDA	170,81
A1F3150121F0	315	16	11	12	NEGRO SIN BANDA	215,56
A1F3550121F0	355	16	11	12	NEGRO SIN BANDA	271,65
A1F4000121F0	400	16	11	12	NEGRO SIN BANDA	342,84
A1F4500121F0	450	16	11	12	NEGRO SIN BANDA	433,27
A1F5000121F0	500	16	11	12	NEGRO SIN BANDA	535,81
A1F5600121F0	560	16	11	12	NEGRO SIN BANDA	665,76
A1F6300121F0	630	16	11	12	NEGRO SIN BANDA	855,91
A1G0900121F0	90	20	9	12	NEGRO SIN BANDA	21,75
A1G1100121F0	110	20	9	12	NEGRO SIN BANDA	32,26
A1G1600121F0	160	20	9	12	NEGRO SIN BANDA	68,44
A1G2000121F0	200	20	9	12	NEGRO SIN BANDA	106,69
A1G2250121F0	225	20	9	12	NEGRO SIN BANDA	132,07
A1G2500121F0	250	20	9	12	NEGRO SIN BANDA	166,08
A1G2800121F0	280	20	9	12	NEGRO SIN BANDA	204,97
A1G3150121F0	315	20	9	12	NEGRO SIN BANDA	258,68
A1G3550121F0	355	20	9	12	NEGRO SIN BANDA	325,98
A1G4000121F0	400	20	9	12	NEGRO SIN BANDA	411,40
A1G4500121F0	450	20	9	12	NEGRO SIN BANDA	519,92
A1G5000121F0	500	20	9	12	NEGRO SIN BANDA	642,98
A1G5600121F0	560	20	9	12	NEGRO SIN BANDA	798,92
A1G6300121F0	630	20	9	12	NEGRO SIN BANDA	1.027,09

FLEXIPOL - MASA - TUBOS DE POLIETILENO PE100 RD

Tubo confeccionado con resina RD de última generación aditivada que le confiere una mayor resistencia a la desinfección realizada en las tuberías de agua potable incluso utilizando Dioxido de Cloro.

Reduce los costes de mantenimiento por ataques químicos. La resina PE-100 RD confiere a la tubería una seguridad 3.5 veces mayor que otras resinas (PEX-b HP, PVC, PE-100 Estándar).

Tubo óptimo para acometidas, donde la influencia de las temperaturas y desinfección afecta más a las instalaciones, y donde el PH del agua es elevado (plantas desaladoras).

Diámetros y espesores conforme a la norma UNE EN-12201 y NF-114 (Francia).



Amplio abanico de certificados disponibles:

ACS de materia prima.

Materia prima certificada por AENOR bajo la UNE EN-12201.

Materia prima homologada por LNE (NF-114) Francia.

Materia prima Certificada por IIP (Istituto Italiano del Plástico) Italia.

Materia prima Certificada por HY (Hygiene-Institut des Ruhrgebiets) Alemania.

FLEXIPOL - TUBOS DE POLIETILENO PE100 RC

Tubo confeccionado con resina RC de última generación que le confiere una mayor resistencia a la propagación lenta y rápida de fisuras y a las cargas puntuales

Cumple con los estrictos requisitos de propagación lenta de fisuras de acuerdo a PAS 1075. Declaración de cumplimiento Hessel disponible.

Ventajas respecto a grados PE 100 Estándar:

Ahorro en costes de obra civil

El tubo puede ser instalado sin lecho de arena

En función del tipo de árido de la excavación éste puede ser reutilizado

Mejor comportamiento en instalaciones “agresivas”.

En instalaciones en terrenos con rocas, piedras etc es importante si el tubo sufre arañazos en la instalación.

Es recomendable para nuevas técnicas de entubado sin zanja: Perforación dirigida, bursting, relining... Donde el tubo sufre abrasión directa

Propiedades Físicas:

Alta resistencia a la propagación lenta de fisuras.

Supera los requisitos estándar del Notched Pipe Test (NPT) según ISO 13479:

Para UNE-EN-1555 > 500h

Para la Asociación PE 100 Plus > 500h

La resina utilizada por MASA > 9.500 h, es decir, superior al año

Supera los requisitos del Full Notch Creep Test (FNCT) Test según ISO 16770:

Para DIBt > 300 h

Para DVGW GW 323 > 3.300 h

La resina utilizada por MASA > 8.760 h, es decir, superior al año

Alta resistencia a la propagación rápida de fisuras.

La resistencia a la propagación rápida de fisuras puede ser medida mediante el Test S4 de acuerdo a la ISO 13477.

La resina utilizada por MASA tiene una alta resistencia en comparación con los requisitos de Ref.:

Para UNE-EN-1555 > 10bar a 0° C

La resina utilizada por MASA alcanza resultados de > 20 bar a -15° C

Amplio abanico de certificados disponibles:

ACS de materia prima y tubo

Materia prima y tubo certificado por AENOR bajo la UNE-

EN-12201 y UNE-EN-1555

Test S4 con diferentes parámetros

Notch Pipe Test >10.500 h

Point Loading Test > 1 Año

DVGW W270

ISO 9080

Compatibilidad de soldadura

Envejecimiento por calor Hessel: Ensayo superado con 2 Mpa

Resistencia al gas condensado

FLEXIPOL - TUBOS DE POLIETILENO PE100 RT

Tubo fabricado con un polietileno de alta densidad (PE100) negro, que combina las tradicionales cualidades de los tubos de polietileno con nuevas propiedades que amplían sus posibilidades y campo de utilización.

- Resistencia química
- Resistencia a la abrasión.
- Buenas propiedades organolépticas (para su uso con agua potable)
- Buena resistencia a la fluencia
- Posibilidad de unión por termofusión.
- Resistencia a la oxidación
- Buena resistencia a la intemperie

- Alta estabilidad dimensional
- Excelentes propiedades de resistencia al agrietamiento por tensión (ESCR)
- Muy buena resistencia hidrostática a largo plazo, incluso a temperaturas elevadas.
- Excelente envejecimiento al calor
- Alta estabilidad frente a la extracción.

Estas propiedades permiten que este tipo de tubos sean utilizados en nuevas aplicaciones, como son el transporte de agua caliente (a temperaturas superiores a los 40°C admitidos para los tubos PE100), unidades de desalinización ó conductos para cables de potencia.



TUBOS FLEXIPOL PE100 RANURADOS O PERFORADOS PARA EL DRENAJE DE LIXIVIADOS Y CAPTACIÓN DE BIOGÁS

Tubos manipulados a partir de tubos estándar de PE100 según UNE-EN-12201

TUBO RANURADO A 1/3 , 2/3 O COMPLETO DE ACUERDO A DIN 4266 Y 4262

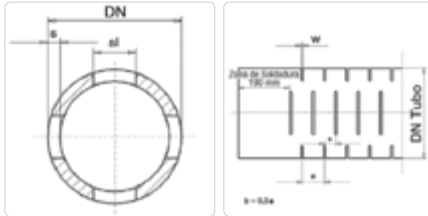

TUBO PERFORADO

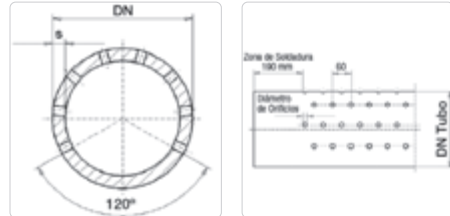

Para medidas solicitar fichas técnicas

TIPOS DE RANURADO

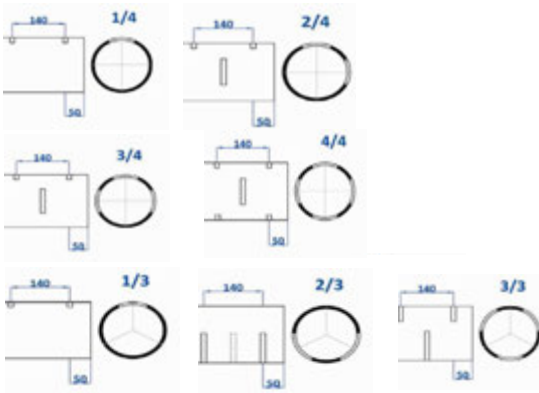

TIPOS DE PERFORACIÓN

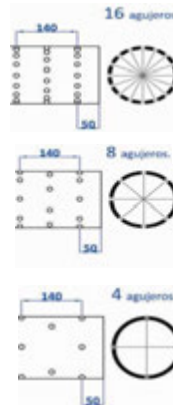

Ø Ext.	PN6	PN10	PN16
63			
75			
90			
110			
125			
140			
160			
180		Consultar	
200			
225			
250			
280			
315			
355			
400			

Ø Ext.	PN6	PN10	PN16
63			
75			
90			
110			
125			
140			
160			
180		Consultar	
200			
225			
250			
280			
315			
355			
400			

Escoger tipo de ranurado, diámetro del tubo y presión.
Ancho ranura 12 mm.

Escoger tipo de perforación, diámetro del tubo y presión.
Ø agujero 12 mm

EXCEL-PLUS®

Tubo multicapa para acometidas de agua potable fabricado con PE100 RC y revestimiento interior de PVDF Kynar®. Certificado Sanitario ACS del laboratorio CARSO Laboratoire Santé Environnement Hygiène de Lyon (Francia). Óptimo comportamiento en lugares de desinfección concentrada y alta temperatura.



Resistencia mecánica

El cuerpo en PE100 RC PN16 conforme a norma UNE-EN-12201 dota al tubo de una mayor resistencia mecánica al punzonamiento y a la propagación rápida y lenta de las fisuras. Gran resistencia a los terrenos corrosivos y a la corrosión electrolítica generada por el transporte en ambientes eléctricos.

Insensibilidad a los desinfectantes

El revestimiento interno de PVDF confiere una protección duradera a la oxidación generada por los desinfectantes. Se trata de un polímero caracterizado por una gran resistencia química a los oxidantes en fuerte concentración y temperatura elevada.

Impermeable a hidrocarburos

Sometido al ensayo (WIS 4-32-19) impuesto a los tubos con barrera de aluminio el tubo Excel Plus® demostró su impermeabilidad a los hidrocarburos presentando idénticas prestaciones que estos multicapas tricapa pero con una mayor facilidad de puesta en obra.

Inhibición de biofilm

El revestimiento interno de PVDF Kynar® ralentiza considerablemente la proliferación bacteriana en las paredes del tubo en comparación con un tubo estándar de PE, o un acero, y facilita la eliminación de ese biofilm.

Instalación con accesorios estándar para PE.

Recomendable realizar la unión con accesorios electrosoldables de alta seguridad FRIALEN®

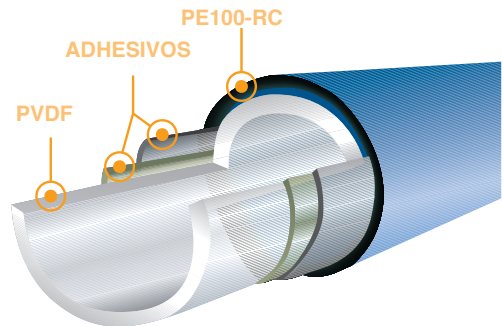

Ø Exterior (mm)	Espesor min. (mm)	Peso (kg/m)	Diámetro rollo 50m (m)	Ancho de rollo (m)	Peso aprox. rollo 50m (kg)	Peso aprox. barra 5m (kg)
25	2,3	0,195	1,20	0,200	10,00	0,98
32	3,0	0,310	1,40	0,200	16,00	1,55
40	3,7	0,469	1,40	0,300	24,00	2,35
50	4,6	0,715	1,70	0,160	36,00	3,58
63	5,8	1,114	1,70	0,260	56,00	5,57
75	6,8	1,542	2,15	0,225	77,11	7,71
90	8,2	2,215	2,50	0,370	110,77	11,08
110	10,0	3,262	-	-	-	16,31



EXCEL-PLUS®

Ref.	Formato	Ø Ext.	Espesor	€/m
X5F0250051M0	Barras 5 mts	25	2,30	9,94
X5F0250502M0	Rollos 50 mts	25	2,30	9,94
X5F0320051M0	Barras 5 mts	32	3,00	13,23
X5F0320502M0	Rollos 50 mts	32	3,00	13,23
X5F0400051M0	Barras 5 mts	40	3,70	18,55
X5F0400502M0	Rollos 50 mts	40	3,70	18,55
X5F0500051M0	Barras 5 mts	50	4,60	21,77
X5F0500502M0	Rollos 50 mts	50	4,60	21,77
X5F0630051M0	Barras 5 mts	63	5,80	29,28
X5F0630502M0	Rollos 50 mts	63	5,80	29,28
X5F0750501M0	Barras 5 mts	75	6,80	39,18
X5F0750502M0	Rollos 50 mts	75	6,80	39,18
X5F0900501M0	Barras 5 mts	90	8,20	48,57
X5F0900502M0	Rollos 50 mts	90	8,20	48,57
X5F1100501M0	Barras 5 mts	110	10,00	62,83

DN	Formato Rollos	Formato Barras
25	Paquetes de 8 rollos (400 metros)	Paquetes de 25 barras (125 metros)
32	Paquetes de 7 rollos (350 metros)	Paquetes de 25 barras (125 metros)
40	Paquetes de 3 rollos (150 metros)	Paquetes de 20 barras (100 metros)
50	Paquetes de 3 rollos (150 metros)	Paquetes de 16 barras (80 metros)
63	Paquetes de 3 rollos (150 metros)	Paquetes de 16 barras (80 metros)
75 a 110	consultar disponibilidad	consultar disponibilidad



SISTEMA DE ACOMETIDA

Set de Acometida	€/ud (Con 1 m de tubo)	€/ud (Con 2 m de tubo)
Set de Acometida DN 25* Toma en carga DAA 63/32 Reducción MR 32/25 Válvula de Bola KH DN 25 Manguito UB DN 25 Tubo Excel Plus DN25	125,52,	137,10
Set de Acometida DN 32* Toma en carga DAA 63/32 Manguito UB DN 32 Válvula de Bola KH DN 32 Manguito UB DN 32 Tubo Excel Plus DN32	134,68	150,06

* Consultar precios para otras medidas y/o longitudes de tubo mayores a 1 y 2 m
Los sets se suministran sin soldar. Posibilidad de suministro con soldaduras bajo petición.

GASYPOL - MASA
TUBOS DE POLIETILENO
PE100 RC

Resistente a la propagación rápida y lenta de fisuras y cargas puntuales



Para Conducción de Combustibles Gaseosos. Fabricados según Norma UNE-EN 1555.
Declaración de cumplimiento Hessel con la PAS 1075 disponible.

COLORES: negro banda amarilla.

MARCAJE*: MASA GASYPOL

**Personalizados bajo petición*

FORMATO DE SUMINISTROS*

Hasta Ø63 en rollos de 100 metros
Ø90 y Ø110 (SDR 11) rollos de 50 metros
Desde Ø110 barras de 8 y 12 metros

**Para otras medidas y SDR consultar la cantidad mínima por pedido en la página 9.*

SDR 11

Ø Ext.	Espesor	€/m
20	3,0	1,63
25	3,0	2,11
32	3,0	2,45
40	3,7	3,66
63	5,8	8,28
90	8,2	16,73
110	10,0	24,82
160	14,6	52,64
200	18,2	82,07
250	22,7	127,75

Ø Medida	C X PALET GAS(Barra/ Rplo)	
	PN 10	PN 16
20		250 (metro)
25		200 (metro)
32	150 (metro)	150 (metro)
40	100 (barra)	100 (barra)
63	131 (barra)	131 (barra)
90	63 (barra)	63 (barra)
110	60 (barra)	43 (barra)
160	28 (barra)	17 (barra)
200	18 (barra)	18 (barra)
250	11 (barra)	11 (barra)
315	4 (barra)	4 (barra)

SDR 17

Ø Ext.	Espesor	€/m
63	3,8	5,65
90	5,4	11,46
110	6,6	17,05
160	9,5	35,62
200	11,9	55,61
250	14,8	86,44
315	18,7	137,53

TUBOS DE POLIETILENO PARA COMUNICACIONES

COLORES

Negro

Personalizados bajo consulta

FORMATO DE SUMINISTROS

Personalizados: rollos y/o bobinas

Monotubo

Ref.	Ø	€/m
011032	32	3,05
010040	40	4,57
011040	40	5,33
012040	40	5,63
010050	50	4,57
011050	50	6,09
011063	63	5,79





Proveedor global de soluciones en agua y energía

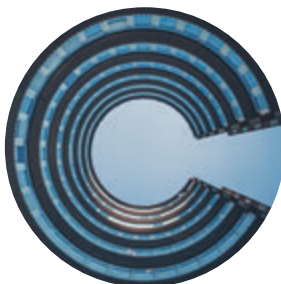

Edificación



Infraestructura



Industria



Agricultura

Trabaja con nuestro equipo de ingenieros y expertos en conducción de fluidos de todo el mundo. Te acompañarán de principio a fin en todos tus proyectos.



Magnum 3G

Sistema para unión de tuberías a presión Magnum 3G

Fitting para tubo de PE

Fitting con inserto de latón

Fitting UTC/PE

Fitting alta resistencia química HCR

Válvulas para contador HCR

Repuestos

Sistema para unión de tuberías a presión

INFRAESTRUCTURA





- Gama de accesorios de compresión para tuberías de Polietileno desde 16 hasta 110 mm de diámetro con sistema desliza y aprieta y montaje en sólo 2 pasos.
- Apto para agua potable y adecuado para el transporte de fluidos a presión en industria, infraestructura, edificación y agricultura con una fiabilidad total. 1.600Kpa (PN16) a 20oC.
- Certificaciones de Ø16 a Ø63: KIWA - ACS- AENOR - IIP - DVGW



J-63

Medida	Ref.	U/	/ n.º	€
16	M55149	50	A-1	3,09
32	M55017	100	A-11	3,83
32	M55018	100	A-11	4,65
32	M55019	100	A-11	6,62
40	M55020	100	A-9	10,36
63	M55003	100	A-9	14,97
63	M55004	100	A-9	22,57
75	M55021	100	A-11	38,81
90	M55022	100	A-9	64,67
110	M55165	2	A-8	100,44

Enlace recto.



J-68

Medida	Ref.	U/	/ n.º	€
20-16	M55153	50	A-2	3,84
25-16	M55229	50	A-2	4,65
25-20	M55041	50	A-2	4,65
32-20	M55374	25	A-2	6,96
32-25	M55042	25	A-2	6,62
40-25	M55375	25	A-11	12,84
40-32	M55043	25	A-11	12,84
50-25	M55376	15	A-11	17,62
50-32	M55377	15	A-11	17,62
50-40	M55044	15	A-11	17,62
63-32	M55378	15	A-9	21,43
63-40	M55379	15	A-9	21,43
63-50	M55045	15	A-9	21,81
75-63	M55070	5	A-11	38,81
90-75	M55071	5	A-9	64,67
110-90	M55221	2	A-8	97,36

Enlace reducido.



J-95

Medida	Ref.	U/	/ n.º	€
20	M55330	100	A-11	5,54
25	M55331	100	A-9	6,81
32	M55332	50	A-9	8,57
40	M55333	50	A-12	14,80
50	M55334	25	A-4	20,27
63	M55335	20	A-12	26,95

Enlace recto para reparaciones.



J-97

Medida	Ref.	U/	/ n.º	€
32	M55394	50	A-9	10,41
40	M55395	25	A-8	14,76
50	M55396	15	A-9	20,15
63	M55397	15	A-12	26,69

Enlace acodado 45°.



J-64

Medida	Ref.	U/	/ n.º	€
16	M55154	50	A-1	3,09
20	M55029	50	A-2	3,83
25	M55030	50	A-11	4,65
32	M55031	50	A-9	6,84
40	M55032	25	A-8	10,36
50	M55009	15	A-9	14,97
63	M55010	15	A-12	22,53
75	M55033	5	A-9	40,06
90	M55034	5	A-4	66,71
110	M55190	2	A-9	157,51

Enlace acodado 90°.



J-69

Medida	Ref.	U/	/ n.º	€
16-1/2"	M55312	50	A-2	3,96
20-1/2"	M55096	50	A-2	3,85
20-3/4"	M55313	50	A-2	3,79
25-1/2"	M55217	50	A-2	4,76
25-3/4"	M55097	50	A-2	4,76
25-1"	M55314	50	A-2	4,66
32-3/4"	M55315	25	A-2	5,85
32-1"	M55098	25	A-2	6,00
32-1 1/4"	M55316	25	A-2	6,00
40-1"	M55317	25	A-11	7,57
40-1 1/4"	M55099	25	A-11	7,82
50-1 1/4"	M55318	20	A-9	10,46
50-1 1/2"	M55163	20	A-9	10,67
50-2"	M55164	20	A-4	16,26

Enlace acodado 90° rosca macho.



J-59

Medida	Ref.	U/	/ n.º	€
63	M55735	10	A-4	33,33

Te 45°.



J-71

SIN REFUERZO METALICO

Medida	Ref.	U/	/ n.º	€
16-1/2"	M55393	50	A-2	3,53
20-1/2"	M55135	50	A-2	4,99
20-3/4"	M55307	50	A-2	4,90
25-1/2"	M55218	50	A-2	5,82
25-3/4"	M55136	50	A-2	5,79
25-1"	M55308	50	A-2	5,69
32-3/4"	M55242	25	A-2	7,24
32-1"	M55137	25	A-2	7,24
32-1 1/4"	M55309	25	A-2	8,35
40-1"	M55310	25	A-11	11,66
40-1 1/4"	M55138	25	A-11	9,04
50-1 1/4"	M55311	20	A-9	13,24
50-1 1/2"	M55159	20	A-9	13,50
50-2"	M55364	20	A-9	14,44
63-2"	M55160	20	A-4	16,57



J-71

CON REFUERZO METALICO

Medida	Ref.	U/	/ n.º	€
20-1/2"	M55175	50	A-2	5,55
20-3/4"	M55366	50	A-2	6,83
25-1/2"	M55225	50	A-2	6,28
25-3/4"	M55176	50	A-2	6,50
25-1"	M55367	50	A-2	6,83
32-3/4"	M55243	25	A-2	8,03
32-1"	M55177	25	A-2	8,03
32-1 1/4"	M55368	25	A-2	8,82
40-1"	M55369	25	A-11	12,12
40-1 1/4"	M55178	25	A-11	12,12
50-1 1/4"	M55370	20	A-9	13,69
50-1 1/2"	M55188	20	A-9	15,45
50-2"	M55371	20	A-9	14,89
63-2"	M55189	20	A-4	19,07
75-2 1/2"	M55257	10	A-9	34,96
90-3"	M55258	6	A-9	47,25
110-4"	M55259	4	A-4	106,48

Enlace acodado 90° rosca hembra..



J-73

Medida	Ref.	U/	/ n.º	€
16	M55150	50	A-2	4,89
20	M55072	100	A-9	5,82
25	M55073	100	A-4	7,01
32	M55074	25	A-8	9,93
40	M55075	25	A-4	15,50
50	M55086	10	A-9	22,61
63	M55087	10	A-4	34,01
75	M55088	5	A-4	66,71
90	M55089	5	A-4	100,94
110	M55191	2	A-4	180,61

Te bocas iguales.



J-74

Medida	Ref.	U/	/ n.º	€
25-20	M55115	50	A-8	7,01
25-32	M55380	50	A-8	9,93
32-25	M55116	25	A-8	12,89
40-25	M55381	25	A-9	15,19
40-32	M55117	25	A-9	15,50
50-25	M55382	10	A-9	23,81
50-32	M55383	10	A-9	23,81
50-40	M55118	10	A-9	23,81
63-25	M55384	10	A-4	27,79
63-32	M55385	10	A-4	32,08
63-50	M55119	10	A-4	33,86

Te 90º reducida al centro



J-96

Medida	Ref.	U/	/ n.º	€
20	M55387	100	A-9	8,45
25	M55388	100	A-4	10,85
32	M55389	25	A-8	14,45
40	M55390	25	A-4	23,49
50	M55391	10	A-9	32,24
63	M55392	10	A-4	43,55

Te 90º para reparaciones.



J-66

Medida	Ref.	U/	/ n.º	€
40-40	M55365	10	A-11	24,38
50-40	M55100	10	A-11	24,38
50-50	M55373	10	A-11	26,74
63-50	M55101	10	A-9	34,52
75-2 1/2"	M55102	5	A-8	39,91
90-3"	M55103	5	A-9	61,87
110-4"	M55222	2	A-11	115,99

Enlace brida.



J-60

Medida	Ref.	U/	/ n.º	€
25-1/2"	M55353	50	A-11	7,10
25-3/4"	M55195	50	A-11	7,24
32-1"	M55196	25	A-11	9,90
40-1 1/4"	M55304	50	A-5	18,16
50-1 1/2"	M55305	15	A-9	22,59
63-2"	M55306	15	A-4	42,49

Te 90º rosca macho..



SIN REFUERZO METALICO

J-65

Medida	Ref.	U/	/ n.º	€
16-1/2"	M55354	100	A-8	4,29
20-1/2"	M55023	100	A-8	4,89
20-3/4"	M55324	100	A-8	6,75
25-1/2"	M55219	50	A-11	6,90
25-3/4"	M55024	100	A-9	6,90
25-1"	M55325	100	A-8	7,28
32-3/4"	M55244	50	A-9	9,45
32-1"	M55025	50	A-9	9,45
32-1 1/4"	M55326	50	A-8	10,68
40-1"	M55328	50	A-12	14,94
40-1 1/4"	M55026	50	A-12	14,94
50-1 1/4"	M55329	15	A-9	16,79
50-1 1/2"	M55007	15	A-9	17,79
63-2"	M55008	15	A-4	27,93



SIN REFUERZO METALICO

J-65

Medida	Ref.	U/	/ n.º	€
32-1"-25	M55327	50	A-9	8,00



CON REFUERZO METALICO

J-65

Medida	Ref.	U/	/ n.º	€
32-1"-25	M55361	50	A-9	9,27

Te 90° rosca hembra reducida.



CON REFUERZO METALICO

J-65

Medida	Ref.	U/	/ n.º	€
20-1/2"	M55183	100	A-8	5,60
20-3/4"	M55358	100	A-8	5,64
25-1/2"	M55224	50	A-11	7,34
25-3/4"	M55184	100	A-9	7,54
25-1"	M55359	100	A-9	7,41
32-3/4"	M55245	50	A-9	10,18
32-1"	M55185	50	A-9	10,18
32-1 1/4"	M55360	50	A-9	11,36
40-1"	M55362	50	A-4	13,47
40-1 1/4"	M55186	50	A-4	15,20
50-1 1/4"	M55363	15	A-9	17,51
50-1 1/2"	M55187	15	A-9	19,07
63-2"	M55141	15	A-4	30,06
75-2 1/2"	M55142	5	A-9	52,20
90-3"	M55143	5	A-4	78,41
110-4"	M55227	2	A-4	167,42



SIN REFUERZO METALICO

J-72

Medida	Ref.	U/	/ n.º	€
20-1/2"	M55076	50	A-2	5,16
25-3/4"	M55077	50	A-11	5,56



CON REFUERZO METALICO

J-72

Medida	Ref.	U/	/ n.º	€
20-1/2"	M55179	50	A-2	6,31
25-3/4"	M55180	50	A-11	7,01

Codo grifo 90°.



J-78

Medida	Ref.	U/	/ n.º	€
16	M55372	50	A-1	2,80
20	M55104	50	A-1	3,09
25	M55105	50	A-2	3,45
32	M55106	25	A-2	5,41
40	M55107	25	A-11	6,67
50	M55108	10	A-2	9,85
63	M55109	10	A-11	14,16
75	M55110	5	A-11	25,23
90	M55111	5	A-8	41,32
110	M55223	2	A-2	83,61

Tapón final.



J-61

Medida	Ref.	U/	/ n.º	€
16-3/8"	M55148	50	A-10	1,93
16-1/2"	M55147	50	A-10	1,93
16-3/4"	M55336	50	A-10	1,90
20-1/2"	M55011	100	A-2	2,37
20-3/4"	M55132	50	A-1	3,27
25-1/2"	M55133	50	A-2	3,27
25-3/4"	M55012	100	A-11	2,97
25-1"	M55213	50	A-2	3,09
32-3/4"	M55214	50	A-11	4,78
32-1"	M55013	100	A-9	4,78
32-1 1/4"	M55215	50	A-11	4,78
32-1 1/2"	M55337	50	A-11	4,70
40-1"	M55216	50	A-9	6,37
40-1 1/4"	M55014	100	A-12	7,37
40-1 1/2"	M55338	100	A-4	6,37
40-2"	M55339	100	A-4	7,37
50-1 1/4"	M55303	25	A-4	8,33
50-1 1/2"	M55001	25	A-8	8,51
50-2"	M55340	25	A-8	10,76
63-1 1/2"	M55341	25	A-4	12,63
63- 2"	M55002	25	A-4	12,87
75-2 1/2"	M55015	5	A-11	22,68
90-3"	M55016	5	A-9	36,74
110-4"	M55192	2	A-11	80,02

Enlace mixto rosca macho.



J-79

Medida	Ref.	U/	/ n.º	€
25-3/4"	M55230	10	A-10	7,24
32-1"	M55231	10	A-1	10,84

Manguito pasamuros.



J-62

SIN REFUERZO METALICO

Medida	Ref.	U/	/ n.º	€
16-1/2"	M55152	50	A-10	2,11
20-1/2"	M55035	100	A-2	2,92
20-3/4"	M55687	50	A-1	2,85
20-1"	M55342	100	A-2	2,85
25-1/2"	M55134	50	A-2	3,68
25-3/4"	M55036	100	A-11	3,68
25-1"	M55246	50	A-2	3,68
32-3/4"	M55320	50	A-11	4,79
32-1"	M55037	100	A-9	4,89
32-1 1/4"	M55321	50	A-11	4,79
40-1"	M55322	50	A-9	6,59
40-1 1/4"	M55038	50	A-8	6,71
40-1 1/2"	M55343	50	A-8	6,59
50-1 1/4"	M55323	25	A-8	9,04
50-1 1/2"	M55005	25	A-8	9,04
50-2"	M55344	25	A-8	9,25
63-2"	M55006	25	A-4	13,74



J-62

CON REFUERZO METALICO

Medida	Ref.	U/	/ n.º	€
20-1/2"	M55169	100	A-2	3,50
20-3/4"	M55345	50	A-1	3,43
25-1/2"	M55170	50	A-2	4,36
25-3/4"	M55171	100	A-11	4,36
25-1"	M55247	50	A-2	4,36
32-3/4"	M55347	50	A-11	5,54
32-1"	M55172	100	A-9	5,65
32-1 1/4"	M55348	50	A-11	5,54
40-1"	M55349	50	A-8	7,71
40-1 1/4"	M55173	50	A-8	7,86
40-1 1/2"	M55350	50	A-8	7,86
50-1 1/4"	M55351	25	A-8	10,88
50-1 1/2"	M55174	25	A-8	11,09
50-2"	M55352	25	A-8	12,18
63-2"	M55144	25	A-4	16,27
75-2 1/2"	M55145	5	A-11	27,61
90-3"	M55146	5	A-8	42,21
110-4"	M55226	2	A-11	100,88

Enlace mixto rosca hembra.

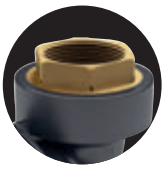

INFRAESTRUCTURA

Sistema para unión de tuberías a presión Magnum 3G

Fitting con inserto de latón



J-62

Medida	Ref.	U/	/ n.º	€
20-1/2"	M55710	50	A-2	17,77
25-3/4"	M55711	60	A-11	20,83
32-1"	M55712	50	A-9	23,58
40-1 1/4"	M55713	25	A-2	32,12
50-1 1/2"	M55714	12	A-2	39,51
63-2"	M55715	12	A-8	57,39

Enlace mixto rosca hembra con inserto de latón.



J-71

Medida	Ref.	U/	/ n.º	€
20-1/2"	M55723	25	A-2	28,70
25-3/4"	M55724	25	A-2	31,23
32-1"	M55725	12	A-1	32,36
40-1 1/4"	M55726	15	A-11	32,36
50-1 1/2"	M55727	10	A-11	39,58
63-2"	M55728	10	A-8	49,22

Enlace acodado 90º rosca hembra con inserto de latón.



J-61

Medida	Ref.	U/	/ n.º	€
20-1/2"	M55701	50	A-2	20,82
25-3/4"	M55702	60	A-11	21,29
32-3/4"	M55703	30	A-11	23,48
32-1"	M55704	50	A-9	23,48
32-1 1/4"	M55705	25	A-11	30,17
32-1 1/2"	M55729	25	A-9	30,17
40-1"	M55706	25	A-8	30,33
40-1 1/4"	M55707	40	A-12	32,13
40-1 1/2"	M55730	25	A-9	32,12
50-1 1/4"	M55731	12	A-2	39,51
50-1 1/2"	M55708	12	A-2	39,51
63-2"	M55709	12	A-8	57,39

Enlace mixto rosca macho con inserto de latón.



J-69

Medida	Ref.	U/	/ n.º	€
20-1/2"	M55716	25	A-2	29,34
25-3/4"	M55717	25	A-2	31,05
32-3/4"	M55718	12	A-2	33,35
32-1"	M55719	12	A-2	33,35
40-1"	M55732	12	A-11	37,03
40-1 1/4"	M55720	15	A-11	38,79
40-1 1/2"	M55733	15	A-11	38,79
40-1 3/4"	M55734	10	A-2	48,24
50-1 1/2"	M55721	10	A-11	48,24
63-2"	M55722	10	A-8	68,28

Enlace acodado 90º rosca macho con inserto de latón.



FITTING UTC/PE

Para la conexión de tubería de PE Métrico a Cobre, PVC, ABS, Acero Inoxidable, Hierro Galvanizado y Plomo

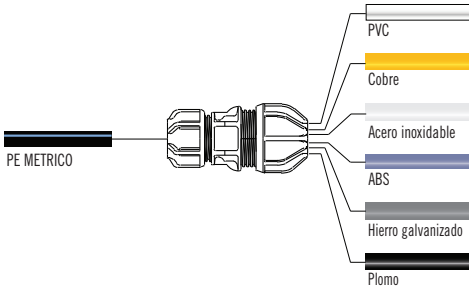

Conexión de PE con una gran variedad de tubos

PVC, cobre, hierro galvanizado, ABS, plomo, acero inoxidable, acero y polietileno.

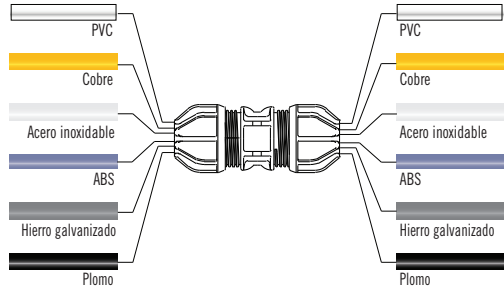

Conexión de una gran variedad de tubos entre sí

PVC, cobre, hierro galvanizado, ABS, plomo, acero inoxidable, acero y polietileno.

INSTALACIÓN RÁPIDA Y FÁCIL - Sistema desliza y aprieta

Completa seguridad

Accesorio premontado, sin riesgo de dañar las tuberías al montar.

Materiales de alto rendimiento

Fabricado con materiales termoplásticos tecnológicamente avanzados.

El Sistema UTC® está clasificado para una presión nominal de 12,5 bar a 20° C..

Cobertura completa

Conectando una amplia variedad de tuberías incluyendo.

Cobre, acero inoxidable, ABS, Hierro galvanizado y plomo.



WATER REGULATIONS ADVISORY SCHEME

WRAS Approval. (United Kingdom)
Cert. n : 1804340

MATERIALES Y COMPONENTES

CONEXIÓN TUBO PE

TUERCA - Acetal

CUERPO - Polipropileno

CASQUILLO PARTIDO - Acetal

JUNTA - Caucho nitrilo

CONEXIÓN UTC

TUERCA - Polipropileno
(34-39, 47-49 y 59-61 - Acetal)

CUERPO - Polipropileno

CASQUILLO PARTIDO - Acetal
con dientes de acero inoxidable

MATERIALES Y COMPONENTES

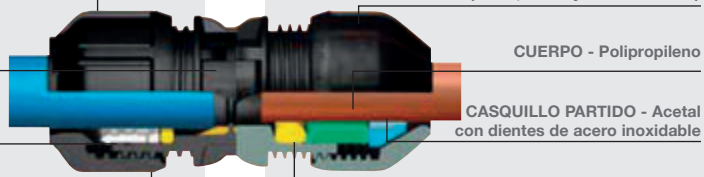



J-63

Medida	Ref.	U/	/ n.º	€
15-21x20	M55453	5	A-10	29,33
21-27x25	M55457	5	A-10	35,06
27-34x32	M55459	5	A-10	49,76
34-39x40	M55462	5	A-10	74,32
47-49x50	M55463	5	A-2	91,24
47-49x63	M55464	5	A-11	104,30
59-61x63	M55465	5	A-2	120,76

Enlace recto transición UTC/PE.



J-61

Medida	Ref.	U/	/ n.º	€
15-21x ¼"	M55485	5	A-10	18,35
21-27x1"	M55488	5	A-10	24,94
27-34x1 ½"	M55493	5	A-10	38,11

Enlace mixto r/macho transición UTC/BSP



J-95

Medida	Ref.	U/	/ n.º	€
15-21x15-21	M55471	5	A-10	39,75
21-27x21-27	M55472	5	A-10	43,56
27-34x27-34	M55473	5	A-10	60,76
34-39x34-39	M55474	5	A-10	83,76
39-43x39-43	M55475	5	A-10	95,83
47-49x47-49	M55476	5	A-10	127,16
59-61x59-61	M55477	5	A-10	135,59

Enlace recto reparacion UTC/UTC.



J-64

Medida	Ref.	U/	/ n.º	€
21-27x25	M55467	5	A-10	37,26
27-34x32	M55470	5	A-10	28,06

Enlace acodado transicion UTC/PE.



J-68

Medida	Ref.	U/	/ n.º	€
21-27x15-21	M55478	5	A-10	43,95
27-34x21-27	M55480	5	A-10	61,34
39-43x27-	M55482	5	A-2	83,21

Enlace reducido reparación UTC/UTC.



J-64

Medida	Ref.	U/	/ n.º	€
21-27x15-21	M55483	5	A-10	30,28
27-34x21-27	M55484	5	A-10	40,12

Enlace acodado UTC/UTC.



INFRAESTRUCTURA

Sistema para unión de tuberías a presión **Magnum 3G**

Fitting alta resistencia química HCR



MAGNUM 3G

SERIE HCR Sistema para unión de tuberías a presión de alta resistencia a la corrosión.

- Sistema Fácil y rápido de instalar
- Seguro y Fiable
- Avanzado e innovador

Sistema MAGNUM 3G SERIE HCR

La nueva serie HCR Magnum 3G aporta una alternativa eficaz a materiales tradicionales en la instalación de acometidas para agua potable en edificación e infraestructura, donde materiales como el latón sufren corrosión y deterioro acelerado debido a los tratamientos para desinfección del agua potable.

Principales características y ventajas del sistema.

Los materiales de la serie HCR MAGNUM 3G están certificados ACS/ AENOR y son aptos para uso en aplicaciones para agua potable.

- Resistencia química.
- Resistencia a la corrosión y a la abrasión.
- Resistencia a la radiación UV.

Áreas de aplicación.

Los materiales tecnológicamente avanzados confieren al SISTEMA MAGNUM 3G características únicas siendo apto para agua potable y adecuado para el transporte de fluidos a presión en infraestructura, edificación e industria, con una fiabilidad total. 1.600Kpa (PN16) a 20 C + FOTOS o iconos de los segmentos.

Certificaciones



ACS (Francia),
Fitting materials approved for use in drinking water applications. XP P 41-280. Cert. n : M3G
15 ACC LY 351 - M3G HCR 15 ACC LY 406.



J-62

Medida	Ref.	U/📦	U/bolsa	📦/n.º	€
20-1/2"	HCR55035	100	10	A-2	6,03
20-3/4"	HCR55687	50	10	A-1	6,03
25-1/2"	HCR55134	50	10	A-2	6,30
25-3/4"	HCR55036	100	10	A-8	6,30
25-1"	HCR55246	50	10	A-2	6,30
32-3/4"	HCR55320	50	5	A-11	8,90
32-1"	HCR55037	100	5	A-9	8,90
32-1 1/4"	HCR55321	50	5	A-11	10,74

Enlace mixto rosca hembra HCR.



J-61

Medida	Ref.	U/📦	U/bolsa	📦/n.º	€
20-1/2"	HCR55011	100	10	A-2	5,88
20-3/4"	HCR55132	50	10	A-1	5,88
25-1/2"	HCR55213	50	10	A-2	6,31
25-3/4"	HCR55133	100	10	A-2	6,31
25-1"	HCR55012	50	10	A-8	6,31
32-3/4"	HCR55214	50	5	A-11	8,18
32-1"	HCR55013	100	5	A-9	8,18
32-1 1/4"	HCR55215	50	5	A-11	11,98

Enlace mixto rosca macho HCR.



J-65

Medida	Ref.	U/	U/bolsa	/ n.º	€
15-21x20	HCR55024	100	10	A-2	43,61
21-27x25	HCR55244	50	5	A-9	54,03
59-61x63	HCR55025	50	5	A-9	54,03

Te 90° rosca hembra HCR



J-69

Medida	Ref.	U/	U/bolsa	/ n.º	€
25-¾"	HCR55097	50	10	A-2	14,05
25-1"	HCR55314	50	10	A-2	14,05
32-¾"	HCR55315	25	5	A-2	16,86
32-1"	HCR5509	25	5	A-2	16,86

Enlace acodado 90° rosca macho HCR.



J-67

Medida	Ref.	U/	U/bolsa	/ n.º	€
25-¾"	HCR55422	50	10	A-2	7,73
25-1"	HCR55423	50	10	A-2	8,35
32-¾"	HCR55424	25	5	A-2	8,53
32-1"	HCR55425	25	5	A-2	9,46

Enlace mixto rosca hembra, con tuerca loca HCR.



J-99

Medida	Ref.	U/	U/bolsa	/ n.º	€
25-¾"	HCR55413	50	10	A-2	22,26
25-1"	HCR55414	50	10	A-2	22,26
32-¾"	HCR55415	25	5	A-2	25,98
32-1"	HCR55416	25	5	A-2	25,98

Enlace acodado 90° rosca hembra, con tuerca loca HCR.



J-72

Medida	Ref.	U/	U/bolsa	/ n.º	€
25-¾"	HCR55077	50	10	A-11	42,31

Codo grifo 90° HCR.



Medida	Ref.	U/	/ n.º	€
20-3/4"	52330	50	A-11	33,53
25-3/4"	52331	50	A-11	34,49
32-3/4"	52332	50	A-8	40,43

Válvula esfera para contador - HCR. Enlace fitting.



Medida	Ref.	U/	/ n.º	€
1/2"-3/4"	52333	50	A-11	32,44
3/4"-3/4"	52334	50	A-11	32,87
1"-3/4"	52335	50	A-11	37,53

Válvula esfera para contador - HCR. Conexión rosca macho



Medida	Ref.	U/	/ n.º	€
25-3/4"	52336	50	A-11	46,36
32-3/4"	52337	50	A-8	54,54

Válvula esfera ángulo para contador - HCR. Enlace fitting.



Medida	Ref.	U/	/ n.º	€
3/4"-3/4"	52338	50	A-11	32,87
1"-3/4"	52339	50	A-11	37,53

Válvula esfera ángulo para contador - HCR. Conexión rosca macho.



Repuestos



Medida	Ref.	U/	/ n.º	€
16	M55157	50	4115	0,49
20	M55052	50	4115	0,58
25	M55053	50	4115	0,64
32	M55054	50	A-10	1,04
40	M55055	50	A-10	1,44
50	M55056	25	A-10	1,76
63	M55057	25	A-10	2,54

Junta de estanqueidad Magnum 3G y Magnum 3G-HCR.



Medida	Ref.	U/	/ n.º	€
20	M55400	50	A-2	0,57
25	M55401	50	A-2	0,63
32	M55402	50	A-2	1,03
40	M55403	50	A-2	1,41
50	M55056	25	A-10	1,76
63	M55057	25	A-10	2,54

Junta de estanqueidad accesorios reparaciones Magnum 3G.



Medida	Ref.	U/	/ n.º	€
16	M55232	50	A-10	0,62
20	M55233	50	A-10	0,65
25	M55234	50	A-1	0,70
32	M55235	50	A-2	1,12
40	M55236	50	A-11	1,90
50	M55237	25	A-11	3,05
63	M55238	25	A-8	5,30

Racor Magnum 3G.



Medida	Ref.	U/	/ n.º	€
20	HCR55233	50	A-10	0,84
25	HCR55234	50	A-10	1,01
32	HCR55235	50	A-2	1,28

Racor Magnum 3G - HCR.



Medida	Ref.	U/	/ n.º	€
16	M55156	50	A-10	0,49
20	M55046	50	A-10	0,58
25	M55047	50	A-10	0,79
32	M55048	50	A-10	0,91
40	M55049	50	A-10	1,05
50	M55050	25	A-10	1,47
63	M55051	25	A-1	1,59
75	M55064	15	A-1	14,02
90	M55065	15	A-2	18,47
110	M55168	15	A-2	27,45

Casquillo partido Magnum 3G.





Medida	Ref.	U/	/ n.º	€
16	HCR55046	50	4115	0,58
20	HCR55047	50	4115	0,79
63	HCR55048	50	A-10	0,91

Casquillo partido Magnum 3G - HCR.



Medida	Ref.	U/	/ n.º	€
20	M55406	20	A-10	3,60
25	M55407	20	A-10	3,64
32	M55408	20	A-10	4,69
40	M55409	10	A-10	5,30
50	M55410	10	A-10	6,66
63	M55411	10	A-1	11,38

Casquillo partido Magnum 3G especial tubo PVC.



Medida	Ref.	U/ 	 / n.º	€
75	M55450	15	A-1	10,23
90	M55451	15	A-2	12,07
110	M55452	15	A-2	13,46

Kit junta de estanqueidad y arandela.



Medida	Ref.	U/ 	 / n.º	€
16-32	055248	20	A-10	40,14
40-63	055249	20	A-2	56,41
75-110	055250	10	A-8	112,10

Llave de apriete fitting Gama 55.

Medida	Ref.	U/ 	 / n.º	€
75	M55441	10	A-2	31,85
90	M55442	10	A-2	37,84
110	M55443	10	A-2	55,04

Kit junta de estanqueidad, casquillo partido, arandela y racor.



Medida	Ref.	U/ 	 / n.º	€
16 a 63	055690	10	A-2	22,45

Llave de apriete fitting universal.

Accesorios manipulados de Polietileno

INFRAESTRUCTURA





Ideal para grandes obras de polietileno en exterior

Aliaxis Iberia cuenta con un taller ampliado recientemente, donde se realizan proyectos integrales en polietileno. Para ello, empleamos la metodología de soldadura a tope.

Con este taller renovado, ampliamos nuestra capacidad para fabricar proyectos en polietileno de hasta diámetro 1.000 mm, pudiendo así atender las necesidades específicas del cliente con soluciones a medida.

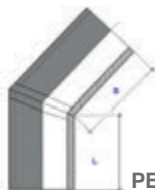

PE 100 SDR 11 CODOS 30°

Ref.	Ø	€/Ud.
089280030160	280	220,74
089315030160	315	308,75
089355030160	355	401,49
089400030160	400	523,21
089450030160	450	708,86
089500030160	500	940,62
089560030160	560	1.276,35
089630030160	630	1.709,21

PE 100 SDR 17 CODOS 30°

Ref.	Ø	€/Ud.
089280030100	280	148,97
089315030100	315	209,46
089355030100	355	272,93
089400030100	400	354,42
089450030100	450	480,20
089500030100	500	637,79
089560030100	560	866,28
089630030100	630	1.158,38
089710030100	710	1.615,99
089800030100	800	2.130,32
089900030100	900	CONSULTAR
089100030100	1000	CONSULTAR



PE 100 SDR 11 CODOS 45°

Ref.	Ø	€/Ud.
089280045160	280	313,87
089315045160	315	428,88
089355045160	355	562,84
089400045160	400	739,78
089450045160	450	989,18
089500045160	500	1.306,41
089560045160	560	1.745,97
089630045160	630	2.340,41

PE 100 SDR 17 CODOS 45°

Ref.	Ø	€/Ud.
089280045100	280	212,81
089315045100	315	290,94
089355045100	355	382,57
089400045100	400	501,16
089450045100	450	670,08
089500045100	500	885,82
089560045100	560	1.185,00
089630045100	630	1.586,18
089710045100	710	2.222,79
089800045100	800	2.927,28
089900045100	900	CONSULTAR
089100045100	1000	CONSULTAR



PE 100 SDR 11 CODOS 60°

Ref.	Ø	€/Ud.
089280060160	280	367,41
089315060160	315	498,68
089355060160	355	660,85
089400060160	400	875,64
089450060160	450	1.167,76
089500060160	500	1.545,99
089560060160	560	2.057,58
089630060160	630	2.770,41

PE 100 SDR 17 CODOS 60°

Ref.	Ø	€/Ud.
089280060100	280	249,12
089315060100	315	338,31
089355060100	355	449,20
089400060100	400	593,21
089450060100	450	791,06
089500060100	500	1.048,30
089560060100	560	1.396,50
089630060100	630	1.877,61
089710060100	710	2.701,04
089800060100	800	3.536,62
089900060100	900	CONSULTAR
089100060100	1000	CONSULTAR

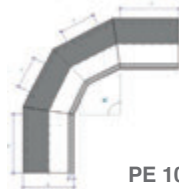

PE 100 SDR 11 CODOS 90°

Ref.	Ø	€/Ud.
089280090160	280	403,37
089315090160	315	544,20
089355090160	355	718,68
089400090160	400	949,01
089450090160	450	1.260,66
089500090160	500	1.660,71
089560090160	560	2.201,20
089630090160	630	2.952,51

PE 100 SDR 17 CODOS 90°

Ref.	Ø	€/Ud.
089280090100	280	273,51
089315090100	315	369,19
089355090100	355	488,51
089400090100	400	642,91
089450090100	450	853,98
089500090100	500	1.126,08
089560090100	560	1.493,98
089630090100	630	2.001,03
089710090100	710	2.754,98
089800090100	800	3.617,59
089900090100	900	CONSULTAR
089100090100	1000	CONSULTAR



PE 100 SDR 11 TES IGUALES

Ref.	Ø	€/Ud.
100280000160	280	422,78
100315000160	315	483,29
100355000160	355	679,52
100400000160	400	1.028,95
100450000160	450	1.302,80
100500000160	500	1.695,35
100560000160	560	2.394,64
100630000160	630	3.104,92

PE 100 SDR 17 TES IGUALES

Ref.	Ø	€/Ud.
100280000100	280	258,97
100315000100	315	362,93
100355000100	355	461,91
100400000100	400	697,06
100450000100	450	882,52
100500000100	500	1.149,57
100560000100	560	1.625,27
100630000100	630	2.104,32
100710000100	710	CONSULTAR
100800000100	800	CONSULTAR
100900000100	900	CONSULTAR
100100000100	1000	CONSULTAR

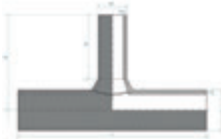

PE 100 SDR 11 TES REDUCIDAS

Ref.	Ø	€/Ud.
105075063160	75/63	CONSULTAR
105090063160	90/63	CONSULTAR
105090075160	90/75	CONSULTAR
105110063160	110/63	CONSULTAR
105110075160	110/75	CONSULTAR
105110090160	110/90	CONSULTAR
105125063160	125/63	CONSULTAR
105125075160	125/75	CONSULTAR
105125090160	125/90	CONSULTAR
105125090160	125/110	CONSULTAR
105140063160	140/63	76,81
105140075160	140/75	83,15
105140090160	140/90	93,13
105140110160	140/110	108,76
105140125160	140/125	189,14
105160063160	160/63	95,91
105160075160	160/75	102,22
105160090160	160/90	112,21
105160110160	160/110	127,81
105160125160	160/125	142,04
105160140160	160/140	211,30
105180063160	180/63	117,01
105180075160	180/75	123,35
105180090160	180/90	133,33
105180110160	180/110	148,92
105180125160	180/125	163,14
105180140160	180/140	178,43
105180160160	180/160	375,59
105200063160	200/63	140,60
105200075160	200/75	146,93

Ref.	Ø	€/Ud.
105200090160	200/90	156,91
105200110160	200/110	172,51
105200125160	200/125	186,73
105200140160	200/140	201,99
105200160160	200/160	226,21
105200180160	200/180	419,31
105225063160	225/63	173,61
105225075160	225/75	179,91
105225090160	225/90	189,89
105225110160	225/110	205,50
105225125160	225/125	219,72
105225140160	225/140	235,00
105225160160	225/160	259,21
105225180160	225/180	286,02
105225200160	225/200	474,00
105250063160	250/63	210,00
105250075160	250/75	216,29
105250090160	250/90	226,28
105250110160	250/110	241,89
105250125160	250/125	256,11
105250140160	250/140	271,37
105250160160	250/160	295,58
105250180160	250/180	322,39
105250200160	250/200	352,32
105250225160	250/225	561,96
105280063160	280/63	264,60
105280075160	280/75	270,90
105280090160	280/90	280,91
105280110160	280/110	296,51
105280125160	280/125	310,73

Ref.	Ø	€/Ud.
105280140160	280/140	326,01
105280160160	280/160	350,21
105280180160	280/180	377,01
105280200160	280/200	406,94
105280225160	280/225	448,82
105280250160	280/250	687,92
105315063160	315/63	335,20
105315075160	315/75	341,51
105315090160	315/90	351,49
105315110160	315/110	367,10
105315125160	315/125	381,32
105315140160	315/140	396,58
105315160160	315/160	420,79
105315180160	315/180	447,60
105315200160	315/200	477,53
105315225160	315/225	519,40
105315250160	315/250	565,57
105315280160	315/280	772,49
105355063160	355/63	436,05
105355075160	355/75	442,37
105355090160	355/90	452,35
105355110160	355/110	467,98
105355125160	355/125	482,17
105355140160	355/140	497,45
105355160160	355/160	521,67
105355180160	355/180	548,45
105355200160	355/200	578,39
105355225160	355/225	620,27
105355250160	355/250	668,90
105355280160	355/280	733,38
105355315160	355/315	830,08
105400063160	400/63	549,06
105400075160	400/75	555,36
105400090160	400/90	565,36
105400110160	400/110	580,96
105400125160	400/125	595,19
105400140160	400/140	610,45
105400160160	400/160	634,67
105400180160	400/180	661,48
105400200160	400/200	691,38
105400225160	400/225	733,28
105400250160	400/250	781,89
105400280160	400/280	846,38
105400315160	400/315	943,09
105400355160	400/355	1.738,77
105450063160	450/63	690,94
105450075160	450/75	697,26
105450090160	450/90	707,25
105450110160	450/110	722,86
105450125160	450/125	737,08
105450140160	450/140	752,34
105450160160	450/160	776,55
105450180160	450/180	803,36
105450200160	450/200	833,28
105450225160	450/225	875,17
105450250160	450/250	923,80

Ref.	Ø	€/Ud.
105450280160	450/280	988,27
105450315160	450/315	1.084,96
105450355160	450/355	1.829,18
105450400160	450/400	1.921,53
105500063160	500/63	936,22
105500075160	500/75	942,49
105500090160	500/90	952,49
105500110160	500/110	968,11
105500125160	500/125	982,33
105500140160	500/140	997,60
105500160160	500/160	1.021,80
105500180160	500/180	1.048,61
105500200160	500/200	1.078,54
105500225160	500/225	1.120,39
105500250160	500/250	1.169,06
105500280160	500/280	1.233,54
105500315160	500/315	1.330,25
105500355160	500/355	3.384,47
105500400160	500/400	3.511,80
105500450160	500/450	2.722,30
105560063160	560/63	1.276,96
105560075160	560/75	1.283,28
105560090160	560/90	1.293,27
105560110160	560/110	1.308,86
105560125160	560/125	1.323,09
105560140160	560/140	1.338,36
105560160160	560/160	1.362,59
105560180160	560/180	1.389,38
105560200160	560/200	1.419,30
105560225160	560/225	1.461,18
105560250160	560/250	1.509,83
105560280160	560/280	1.574,29
105560315160	560/315	1.670,99
105560355160	560/355	3.751,58
105560400160	560/400	3.878,91
105560450160	560/450	3.089,41
105560500160	560/500	3.251,96
105630063160	630/63	1.752,58
105630075160	630/75	1.758,87
105630090160	630/90	1.768,87
105630110160	630/110	1.784,48
105630125160	630/125	1.798,70
105630140160	630/140	1.813,96
105630160160	630/160	1.838,17
105630180160	630/180	1.864,99
105630200160	630/200	1.894,89
105630225160	630/225	1.936,79
105630250160	630/250	1.985,41
105630280160	630/280	2.049,91
105630315160	630/315	2.146,60
105630355160	630/355	5.353,13
105630400160	630/400	5.461,80
105630450160	630/450	4.648,91
105630500160	630/500	3.762,64
105630560160	630/560	3.950,70

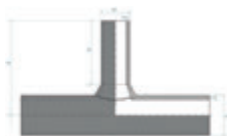

PE 100 SDR 17 TES REDUCIDAS

Ref.	Ø	€/Ud.
105250063100	250/63	142,17
105250075100	250/75	146,64
105250090100	250/90	153,37
105250110100	250/110	164,14
105250125100	250/125	173,18
105250140100	250/140	183,92
105250160100	250/160	200,02
105250180100	250/180	218,17
105250200100	250/200	238,46
105250225100	250/225	441,43
105280063100	280/63	179,50
105280075100	280/75	183,97
105280090100	280/90	190,69
105280110100	280/110	201,46
105280125100	280/125	210,51
105280140100	280/140	220,19
105280160100	280/160	237,31
105280180100	280/180	255,49
105280200100	280/200	275,78
105280225100	280/225	304,61
105280250100	280/250	526,69
105315063100	315/63	227,45
105315075100	315/75	231,94
105315090100	315/90	238,66
105315110100	315/110	249,44
105315125100	315/125	258,49
105315140100	315/140	269,23
105315160100	315/160	285,30
105315180100	315/180	303,50
105315200100	315/200	323,75
105315225100	315/225	352,59
105315250100	315/250	383,24
105315280100	315/280	584,47
105355063100	355/63	296,44
105355075100	355/75	300,96
105355090100	355/90	307,63
105355110100	355/110	318,41
105355125100	355/125	327,47
105355140100	355/140	338,21
105355160100	355/160	354,27
105355180100	355/180	372,47
105355200100	355/200	392,73
105355225100	355/225	421,57
105355250100	355/250	453,88
105355280100	355/280	1.424,46
105355315100	355/315	1.202,77
105400063100	400/63	372,04
105400075100	400/75	376,52
105400090100	400/90	383,24

Ref.	Ø	€/Ud.
105400110100	400/110	394,01
105400125100	400/125	403,06
105400140100	400/140	413,80
105400160100	400/160	429,88
105400180100	400/180	448,06
105400200100	400/200	468,32
105400225100	400/225	497,17
105400250100	400/250	529,48
105400280100	400/280	573,57
105400315100	400/315	639,28
105400355100	400/355	1.384,25
105450063100	450/63	468,16
105450075100	450/75	472,63
105450090100	450/90	479,35
105450110100	450/110	490,12
105450125100	450/125	499,17
105450140100	450/140	509,90
105450160100	450/160	525,97
105450180100	450/180	544,15
105450200100	450/200	564,43
105450225100	450/225	593,28
105450250100	450/250	625,58
105450280100	450/280	669,69
105450315100	450/315	735,39
105450355100	450/355	1.445,31
105450400100	450/400	1.507,11
105500063100	500/63	634,89
105500075100	500/75	639,37
105500090100	500/90	646,09
105500110100	500/110	656,86
105500125100	500/125	665,91
105500140100	500/140	676,64
105500160100	500/160	692,72
105500180100	500/180	710,90
105500200100	500/200	731,18
105500225100	500/225	760,03
105500250100	500/250	792,32
105500280100	500/280	836,42
105500315100	500/315	902,12
105500355100	500/355	2.771,59
105500400100	500/400	2.856,80
105500450100	500/450	2.116,51
105560063100	560/63	866,76
105560075100	560/75	871,25
105560090100	560/90	877,95
105560110100	560/110	888,71
105560125100	560/125	897,79
105560140100	560/140	908,51
105560160100	560/160	924,60

Ref.	Ø	€/Ud.
105560180100	560/180	942,76
105560200100	560/200	963,04
105560225100	560/225	991,87
105560250100	560/250	1.024,20
105560280100	560/280	1.068,29
105560315100	560/315	1.134,00
105560355100	560/355	3.021,40
105560400100	560/400	3.106,60
105560450100	560/450	2.366,35
105560500100	560/500	2.570,13
105630063100	630/63	1.187,85
105630075100	630/75	1.192,33
105630090100	630/90	1.199,05
105630110100	630/110	1.209,81

Ref.	Ø	€/Ud.
105630125100	630/125	1.218,87
105630140100	630/140	1.229,61
105630160100	630/160	1.245,68
105630180100	630/180	1.263,87
105630200100	630/200	1.284,12
105630225100	630/225	1.312,97
105630250100	630/250	1.345,28
105630280100	630/280	1.389,38
105630315100	630/315	1.455,09
105630355100	630/355	4.376,67
105630400100	630/400	4.449,41
105630450100	630/450	3.693,28
105630500100	630/500	2.821,64
105630560100	630/560	2.949,74



PE 100 SDR 11 REDUCCIONES

Ref.	Ø	€/Ud.
110225160160	225/160	486,55
110225180160	225/180	317,24
110225200160	225/200	335,28
110250180160	250/180	590,94
110250225160	250/225	400,95
110280200160	280/200	633,29
110280225160	280/225	417,40
110280250160	280/250	489,33
110315225160	315/225	644,19
110315250160	315/250	488,56
110315280160	315/280	530,09
110355250160	355/250	1.328,50
110355280160	355/280	1.386,37
110355315160	355/315	1.150,94
110400280160	400/280	1.429,01
110400315160	400/315	1.193,56
110400355160	400/355	1.338,02
110450315160	450/315	1.937,36
110450355160	450/355	1.324,44
110450400160	450/400	1.420,70
110500355160	500/355	2.707,49
110500400160	500/400	2.838,74
110500450160	500/450	2.054,16
110560400160	560/400	2.934,38
110560450160	560/450	2.149,77
110560500160	560/500	2.317,84
110630450160	630/450	2.170,78
110630500160	630/500	2.450,19
110630560160	630/560	2.645,54

PE 100 SDR 17 REDUCCIONES

Ref.	Ø	€/Ud.
110225160100	225/160	419,61
110225180100	225/180	259,92
110225200100	225/200	272,15
110250180100	250/180	505,85
110250225100	250/225	332,49
110280200100	280/200	534,64
110280225100	280/225	343,72
110280250100	280/250	392,05
110315225100	315/225	558,02
110315250100	315/250	391,60
110315280100	315/280	419,98
110355250100	355/250	1.166,18
110355280100	355/280	1.205,75
110355315100	355/315	985,68
110400280100	400/280	1.234,31
110400315100	400/315	1.014,25
110400355100	400/355	1.112,78
110450315100	450/315	1.760,50
110450355100	450/355	1.103,42
110450400100	450/400	1.167,86
110500355100	500/355	2.312,56
110500400100	500/400	2.400,42
110500450100	500/450	1.663,46
110560400100	560/400	2.465,51
110560450100	560/450	1.663,46
110560500100	560/500	1.936,12
110630450100	630/450	2.800,07
110630500100	630/500	1.932,18
110630560100	630/560	2.065,22
110710500100	710/500	CONSULTAR
110710560100	710/560	CONSULTAR
110710630100	710/630	CONSULTAR
110800560100	800/560	CONSULTAR
110800630100	800/630	CONSULTAR
110800710100	800/710	CONSULTAR
110900630100	900/630	CONSULTAR
110900710100	900/710	CONSULTAR
110900800100	900/800	CONSULTAR
110100710100	1000/710	CONSULTAR
110100800100	1000/800	CONSULTAR
110100900100	1000/900	CONSULTAR

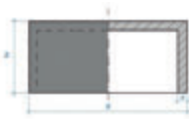

PE 100 SDR 11 TAPONES

Ref.	Ø	€/Ud.
138280000160	280	210,44
138315000160	315	263,04
138355000160	355	350,74
138400000160	400	438,42
138450000160	450	526,10
138500000160	500	613,80
138560000160	560	701,46
138630000160	630	789,17

PE 100 SDR 17 TAPONES

Ref.	Ø	€/Ud.
138280000100	280	149,07
138315000100	315	184,13
138355000100	355	245,50
138400000100	400	315,66
138450000100	450	377,05
138500000100	500	438,42
138560000100	560	499,81
138630000100	630	561,17
138710000100	710	CONSULTAR
138800000100	800	CONSULTAR

Bridas, portabridas, pasamuros y juntas

INFRAESTRUCTURA





BRIDAS DE ACERO CINCADO
PN10 (DIN 2576) MOP 10 BAR

Ref.	PN	Ø Tubo	DN	Nº Agujeros	€/Ud
311050016055	10/16	50	40	4	11,91
311063016055	10/16	63	50	4	13,87
311075016055	10/16	75	65	4	16,97
311090016055	10/16	90	80	8	21,40
311110016055	10/16	110	100	8	23,60
311125016055	10/16	125	125	8	31,73
311140016055	10/16	140	125	8	26,64
311160016055	10/16	160	150	8	40,06
311180016055*	10/16	180	150	8	50,00
311200010055	10	200	200	8	55,23
311225010055*	10	225	200	8	71,67
311250010055	10	250	250	12	57,63
311280010055*	10	280	250	12	89,75
311315010055	10	315	300	12	74,22
311355010055	10	355	350	16	100,85
311400010055	10	400	400	16	141,05
311450010055*	10	450	450	20	Consultar
311500010155*	10	450-500	500	20	311,51
311500010055	10	500	500	20	201,71
311560010055*	10	560	600	20	390,64
311630010055	10	630	600	20	263,36
311710010055*	10	710	700	24	508,12
311800010055*	10	800	800	24	677,07
311900010055*	10	900	900	28	811,68
311100010055*	10	1000	1000	28	1.035,81

* Galvanizadas

BRIDAS DE ACERO CINCADO
PN16 (DIN 2502) MOP 16 BAR

Ref.	PN	Ø Tubo	DN	Nº Agujeros	€/Ud
311200016055	16	200	200	12	54,30
311225016055*	16	225	200	12	69,04
311250016055	16	250	250	12	72,25
311280016055*	16	280	250	12	97,75
311315016055	16	315	300	12	94,23
311355016055	16	355	350	16	136,23
311400016055	16	400	400	16	171,16
311450016055*	16	450	450	20	Consultar
311500016155*	16	450-500	500	20	422,16
311500016055	16	500	500	20	339,41
311560016055*	16	560	600	20	663,95
311630016055	16	630	600	20	459,15
311710016055*	16	710	700	24	660,97
311800016055*	16	800	800	24	838,62
311900016055*	16	900	900	28	996,51
311100016055*	16	1000	1000	28	1.328,93

* Galvanizadas



BRIDAS CIEGAS DE ACERO CINCADO
PN10 (DIN 2527) MOP 10/16 Y 10 BAR

Ref.	DN Brida	PN	Nº Agujeros	€/Ud
312015010055	1/2" 15	10/16	4	5,36
312020010055	3/4" 20	10/16	4	7,55
312025010055	1 " 25	10/16	4	9,16
312032010055	1 1/4" 32	10/16	4	11,94
312040010055	1 1/2" 40	10/16	4	13,85
312050010055	2" 50	10/16	4	19,07
312065010055	2 1/2" 65	10/16	4	23,67
312080010055	3 " 80	10/16	4	30,85
312100010055	4 "100	10/16	8	36,53
312125010055	5" 125	10/16	8	54,86
312150010055	6" 150	10/16	8	67,27
312200010055	8" 200	10	8	106,65
312250010055	10" 250	10	12	155,19
312300010055	12" 300	10	12	199,72
312350010055	14" 350	10	16	260,62
312400010055	16" 400	10	16	319,82
312450010055	18" 450	10	20	407,01
312500010055	20" 500	10	20	484,81
312600010055	24" 600	10	20	708,00

BRIDAS CIEGAS DE ACERO CINCADO
PN16 (DIN 2527) MOP 16 BAR

Ref.	DN Brida	PN	Nº Agujeros	€/Ud
312200016055	8" 200	16	12	103,07
312250016055	10" 250	16	12	159,10
312300016055	12" 300	16	12	223,71
312350016055	14" 350	16	16	304,12
312400016055	16" 400	16	16	404,36
312450016055	18" 450	16	20	553,84
312500016055	20" 500	16	20	649,42
312600016055	24" 600	16	20	907,32

ODB



T1

d	Ref.	DN	PN	€
20	ODB020	15	16	9,84
25	ODB025	20	16	10,82
32	ODB032	25	16	13,95
40	ODB040	32	16	16,91
50	ODB050	40	16	19,77
63	ODB063	50	16	24,58
75	ODB075	65	16	27,17
90	ODB090	80	16	32,36
110	ODB110	100	16	39,05
125	ODB125	100	16	39,05
140	ODB140	125	16	58,39
140	ODB140DN125	*125	16	55,98
160	ODB160	150	16	59,47
180	ODB180	150	16	68,20
200	ODB200PN16	200	16	91,11
225	ODB225PN16	200	16	91,11
250	ODB250PN16	250	16	114,05
280	ODB280PN16	250	16	116,19
315	ODB315PN16	300	16	177,41
355	ODB355PN16	350	16	332,13
400	ODB400PN16	400	16	479,28
450	ODB450PN16	450	16	856,97
500	ODB500PN16	500	16	856,97
560	ODB560PN16	600	16	1.162,16
630	ODB630PN16	600	16	1.178,68

Brida loca PP con alma de acero
DIN 2501 DIN 16962/16963.

* Para portabridas PVC-U

A partir de Ø 75 no utilizar
con portabridas socket
(sólo testa)

ODB



T1

d	Ref.	DN	PN	€
200	ODB200	200	10	89,33
225	ODB225	200	10	89,33
225	ODB225DN200	*200	10	115,01
250	ODB250	250	10	111,81
280	ODB280	250	10	113,91
280	ODB280DN250	*250	10	119,08
315	ODB315	300	10	173,93
315	ODB315DN300	*300	10	174,41
355	ODB355	350	10	325,62
400	ODB400	400	10	469,89
450	ODB450	450	10	840,17
500	ODB500	500	10	840,17
560	ODB560	600	10	1.139,37
630	ODB630	600	10	1.139,37

Brida loca PP con alma de acero
DIN 2501 DIN 16962/16963.

* Para portabridas PVC-U

A partir de Ø 75 no utilizar
con portabridas socket
(sólo testa)

OAB



T1

d	Ref.	DN	€
½"	OAB012	15	12,24
¾"	OAB034	20	15,24
1"	OAB100	25	17,97
1¼"	OAB114	32	20,71
1½"	OAB112	40	25,81
2"	OAB200	50	32,10
2½"	OAB212	65	39,64
3"	OAB300	80	46,48
4"	OAB400	100	60,63
8"	OAB800	200	165,71
10"	OAB810	250	213,41
12"	OAB812	300	329,18
14"	OAB814	350	621,10
16"	OAB816	400	757,32

Brida loca PP con alma de acero
ANSI 150 lbs.

A partir de Ø 75 no utilizar
con portabridas socket
(sólo testa)

ODBC



T1

d	Ref.	DN	PN	€
20	ODBC020	15	16	75,20
25	ODBC025	20	16	76,37
32	ODBC032	25	16	78,31
40	ODBC040	32	16	83,87
50	ODBC050	40	16	95,01
63	ODBC063	50	16	103,43
75	ODBC075	65	16	121,18
90	ODBC090	80	16	133,35
110/125	ODBC110	100	16	182,19
140	ODBC140	125	16	223,71
160/180	ODBC160	150	16	282,31
200/225	ODBC200	200	10	313,55
250/280	ODBC250	250	10	409,74
315	ODBC315	300	10	598,17
355	ODBC355	350	10	1.170,10
400	ODBC400	400	10	1.336,64

Brida ciega PP con alma de acero **DIN 2501**

OABC



T1

d	Ref.	DN	€
½"	OABC012	15	87,44
¾"	OABC034	20	88,68
1"	OABC100	25	90,84
1¼"	OABC114	32	97,34
1½"	OABC112	40	110,54
2"	OABC200	50	120,28
2½"	OABC212	65	137,45
3"	OABC300	80	154,96
4"	OABC400	100	211,74
6"	OABC600	150	328,26
8"	OABC800	200	364,53
10"	OABC810	250	476,02
12"	OABC812	300	695,68

Brida ciega PP con alma de acero **ANSI 150 lbs.**



**PORTABRIDAS INYECTADO
CUELLO LARGO SDR 11**

*Máxima presión de trabajo permitida
16 bar (agua) / 10 bar (gas)*

Ref.	Ø	€/Ud
4013025	25	3,25
4013032	32	4,13
4013040	40	4,42
4013050	50	4,97
4013063	63	5,38
4013075	75	7,09
4013090	90	9,12
4013110	110	12,34
4013125	125	15,15
4013140	140	22,41
4013160	160	25,92
4013180	180	30,84
4013200	200	45,57
4013225	225	48,66
4013250	250	88,47
4013280	280	113,50
4013315	315	146,08
4013355	355	265,79
4013400	400	413,41
4013450	450	482,38
4013500	500	535,97
4013560	560	CONSULTAR
4013630	630	CONSULTAR

**PORTABRIDAS INYECTADO
CUELLO LARGO SDR 17**

*Máxima presión de trabajo permitida
10 bar (agua) / 5 bar (gas)*

Ref.	Ø	€/Ud
4013050010	50	8,14
4013063010	63	11,01
4013075010	75	12,91
4013090010	90	8,20
4013110010	110	11,69
4013125010	125	14,12
4013140010	140	20,85
4013160010	160	24,02
4013180010	180	28,17
4013200010	200	34,41
4013225010	225	44,84
4013250010	250	92,07
4013280010	280	108,50
4013315010	315	137,64
4013355010	355	216,95
4013400010	400	399,80
4013450010	450	481,23
4013500010	500	535,97
4013560010	560	680,59
4013630010	630	871,37



PORTABRIDAS MANIPULADO SDR 11

Máxima presión de trabajo permitida 16 bar (agua)

Ref.	Ø	€/Ud
136280000160	280	260,89
1363150000160	315	354,82
1363550000160	355	555,37
1364000000160	400	706,93
1364500000160	450	1.128,32
1365000000160	500	1.148,85
1365600000160	560	1.663,55
1366300000160	630	1.693,58

PORTABRIDAS MANIPULADO SDR 17

Máxima presión de trabajo permitida 10 bar (agua)

Ref.	Ø	€/Ud
136280000100	280	178,26
1363150000100	315	243,17
1363550000100	355	376,58
1364000000100	400	486,13
1364500000100	450	777,57
1365000000100	500	806,10
1365600000100	560	1.183,50
1366300000100	630	1.176,25
1367100000100	710	1.749,36
1368000000100	800	2.265,64
1369000000100	900	CONSULTAR
1361000000100	1000	CONSULTAR



QBE - PORTABRIDAS CORTOS PE 100 SDR 11

Máxima presión de trabajo permitida 16 bar (agua) / 10 bar (gas)

Ref.	Ø	€/Ud
QBE11020	20	2,69
QBE11025	25	2,69
QBE11032	32	3,18
QBE11040	40	3,83
QBE11050	50	4,68
QBE11063	63	5,81
QBE11075	75	6,91
QBE11090	90	9,85
QBE11110	110	12,72
QBE11125	125	15,35
QBE11140	140	17,91
QBE11160	160	22,61
QBE11180	180	35,07
QBE11200	200	38,66
QBE11225	225	43,04
QBE11250	250	65,35
QBE11280	280	71,35
QBE11315	315	84,06
QBE11355	355	226,10
QBE11400	400	280,01
QBE11450	450	522,54
QBE11500	500	437,20
QBE11560	560	676,31
QBE11630	630	573,80
QBE11710	710	878,25
QBE11800	800	1.211,16

QBE - PORTABRIDAS CORTOS PE 100 SDR 17

Máxima presión de trabajo permitida 10 bar (agua) / 5 bar (gas)

Ref.	Ø	€/Ud
QBE17050	50	4,25
QBE17063	63	5,21
QBE17075	75	6,21
QBE17090	90	9,09
QBE17110	110	11,51
QBE17125	125	14,11
QBE17140	140	16,42
QBE17160	160	20,34
QBE17180	180	29,72
QBE17200	200	37,16
QBE17225	225	41,60
QBE17250	250	59,48
QBE17280	280	58,54
QBE17315	315	80,24
QBE17355	355	150,26
QBE17400	400	195,02
QBE17450	450	363,77
QBE17500	500	321,09
QBE17560	560	519,20
QBE17630	630	409,90
QBE17710	710	702,60
QBE17800	800	897,76
QBE17900	900	1.073,42
QBE171000	1000	1.666,50



PASAMUROS DE PE

Con extremo liso & brida según EN1092 PN10

Ref.	DN	Ø	L	€/Ud
750310106	25	32	250	186,56
750410106	32	40	250	215,75
750510106	40	50	250	228,47
750610106	50	63	250	243,78
750710106	65	75	250	273,22
750910106	80	90	250	337,75
751110106	100	110	250	356,40
751210106	100	125	250	366,41
751310106	125	125	250	379,88
751410106	125	140	250	416,96
751610106	150	160	250	480,11
751810106	150	180	250	522,88
752010106	200	200	250	567,14
752210106	200	225	250	612,55
752510106	250	250	250	745,15
752810106	250	280	250	812,69
753110106	300	315	250	852,83
753410106	300	355	250	1.013,60
753510106	350	355	250	1.097,85
753910106	350	400	250	1.332,62
754010106	400	400	250	1.329,77
754410106	400	450	250	1.571,71
754510106	500	450	250	1.595,30
755010106	500	500	250	2.030,35
755410106	500	560	250	2.197,90
755610106	600	560	300	1.991,19
756310106	600	630	300	2.986,22
757110106	700	710	350	CONSULTAR
758010106	800	800	350	CONSULTAR
759010106	900	900	400	CONSULTAR
759110106	1000	1000	400	CONSULTAR

Junta central en EPDM, anclajes en acero cincado.
Extremo liso SDR 17 según 12201.

Para paredes con espesor = L.

Consultar alternativa en PN16.

Consultar longitudes extra.

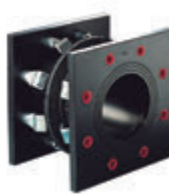

PASAMUROS DE PE

Embridado según EN1092 PN10

Ref.	DN	Ø	L	€/Ud
750320106	25	32	250	255,08
750420106	32	40	250	344,34
750520106	40	50	250	497,01
750620106	50	63	250	400,89
750720106	65	75	250	468,23
750920106	80	90	250	532,33
751120106	100	110	250	586,61
751220106	100	125	250	602,93
751320106	125	125	250	617,42
751420106	125	140	250	685,28
751620106	150	160	250	801,14
751820106	150	180	250	846,55
752020106	200	200	250	919,69
752220106	200	225	250	989,26
752520106	250	250	250	1.236,90
752820106	250	280	250	1.317,80
753120106	300	315	250	1.419,21
753420106	300	355	250	1.656,78
753520106	350	355	250	1.779,77
753920106	350	400	250	2.188,03
754020106	400	400	250	2.252,77
754420106	400	450	250	2.490,27
754520106	500	450	250	3.097,42
755020106	500	500	250	3.369,87
755420106	500	560	250	3.741,07
755620106	600	560	300	3.510,51
756320106	600	630	300	4.963,83
757120106	700	710	350	CONSULTAR
758020106	800	800	350	CONSULTAR
759020106	900	900	400	CONSULTAR
759120106	1000	1000	400	CONSULTAR

Junta central en EPDM, anclajes en acero cincado
Extremo liso SDR 17 según 12201

Para paredes con espesor = L.

Consultar alternativa en PN16.

*Otras configuraciones: pasamuros en ángulo disponibles
previa consulta.*



JUNTAS YUNTA FLEX

Ref.	Ø Tubo	DN Brida	Uds./caja	€/Ud
315020045535	20	15	50	1,73
315025055535	25	20	50	1,75
315030065535	32	25	50	1,84
315045085535	50	40	50	1,92
315055100535	63	50	50	2,06
315070120535	75	65	50	2,17
315085135535	90	80	50	2,50
315105155535	110	100	50	2,52
315135185535	125	125	50	2,79
315160210535	160	150	50	3,42
315210265535	200	200	50	4,58
315260320535	250	250	25	4,82
315310375535	315	300	15	7,57
315360435535	355	350	15	11,65
315410485535	400	400	15	12,11
315510610535	500	500	15	21,69
315610725535	630	600	15	28,90

Junta de plástico flexible, totalmente terminada que no requiere otra manipulación que la de su inmediata colocación entre bridas de unión de dos tubos durante su atornillado. Anticorrosivas, impermeables, imputrescibles e inalterables a la acción de la mayoría de los ácidos, aceites e hidrocarburos. Resistencia a la temperatura de hasta 60°C y presiones hasta 30 atmósferas. Sin desperdicios por recortes ni costes de mano de obra por manipulación. Se mantienen fijas con tan solo dos dedos durante el atornillado de las bridas entre sí. Duración ilimitada.



QPV-J

Ref.	Ø	€/FKM
QHVX020F	20	5,77
QHVX025F	25	5,77
QHVX032F	32	9,66
QHVX040F	40	13,48
QHVX050F	50	13,37
QHVX063F	63	22,52
QHVX075F	75	30,05
QHVX090F	90	33,33
QHVX110F	110	59,84
QHVX125F	125	82,57
QHVX140F	140	95,41
QHVX160F	160	139,83

Junta plana para portabridas.
Junta en FKM (vitón).



QPV-J

Ref.	Ø	€/EPDM
QHVX020E	20	1,06
QHVX025E	25	1,18
QHVX032E	32	1,78
QHVX040E	40	2,04
QHVX050E	50	2,45
QHVX063E	63	3,23
QHVX075E	75	4,99
QHVX090E	90	7,20
QHVX110E	110	9,14
QHVX125E	125	10,24
QHVX140E	140	4,56
QHVX160E	160	12,78
QHVX200E	200	14,98
QHVX225E	225	18,60
QHVX250E	250	52,22

Junta plana para portabridas.
Junta en EPDM.

Accesorios electrosoldables PE

Tomas simples

Tomas en carga

Válvulas PE para agua y gas

Accesorios electrosoldables

Frialen

INFRAESTRUCTURA





Aplicación



Aplicación

**MB - MANGUITOS CON TOPE, SDR 11**

Máxima presión de trabajo permitida 16 bar (agua) / 10 bar (gas)

Ref.	Ø	Ud./Caja	€/Ud.
612680	20	110	2,75
612681	25	90	2,82
616517	32	60	2,87
612683	40	40	3,22
612684	50	25	5,01
612685	63	15	4,36
612686	75	50	7,61
612687	90	30	8,18

Los manguitos MB SDR11 pueden ser soldados en tuberías SDR11 a SDR17,6

Espesor mínimo de tubo a soldar: 3.0 mm

UB - MANGUITOS SIN TOPE, SDR 11

Máxima presión de trabajo permitida 16 bar (agua) / 10 bar (gas)

Ref.	Ø	Ud./Caja	€/Ud.
612668	110	24	10,32
612669	125	16	14,18
615001	140	12	19,03
612671	160	8	19,18
612672	180	6	33,11
612673	200	1	37,00
612674	225	1	46,89
612675	250	1	90,73
615073	280	1	122,25
612670	315	1	147,91
615074	355	1	200,20
615075	400*	1	293,61
615076	450*	1	523,32
615124	500*	1	605,83
616312	560*	1	2.270,69
616269	630*	1	2.571,73
616313	710*	1	2.898,95
616314	800*	1	7.382,31

*** zonas de soldadura separada**

Los manguitos UB SDR11 pueden ser soldados en tuberías SDR11 a SDR17,6

Espesor mínimo de tubo a soldar: 3.0 mm



Aplicación

**UB SDR9 - MANGUITOS SIN TOPE, SDR 9**

Máxima presión de trabajo permitida 20 bar (agua)

Ref.	Ø	Ud./Caja	€/Ud.
616441	400	1	726,76
616447	450	1	890,87
616445	500	1	1.257,26
616446	560	1	2.981,96
616439	630	1	4.133,66

Los manguitos UB SDR9 pueden ser soldados en tuberías SDR9 y SDR11



Aplicación



UB - MANGUITOS SIN TOPE, SDR 17

Máxima presión de trabajo permitida 10 bar (agua) / 5 bar (gas)

Ref.	Ø	Ud./Caja	€/Ud.
616529	315	1	119,78
616530	355	1	199,76
616531	400*	1	220,56
616532	450*	1	312,70
616533	500*	1	424,55
615706	560*	1	643,11
615726	630*	1	830,64
615994	710*	1	1.142,99
616290	800*	1	1.500,45
616345	900*	1	2.020,54
616403	1000**	1	9.307,51
616416	1200**	1	16.565,08

* zonas de soldadura separada

** Para soldar se necesita una FRIAMAT XL

Los manguitos UB SDR17 pueden ser soldados en tuberías SDR17 y SDR26



Aplicación



AM - MANGUITOS SIN TOPE, SDR 17

Máxima presión de trabajo permitida 10 bar (agua)

Ref.	Ø	Ud./Caja	€/Ud.
680001	110	24	11,66
680013	125	22	16,58
680002	160	12	15,35
680003	180	8	26,83
680004	200	1	26,93
680005	225	4	45,77
680006	250	1	108,70
680007	280	1	117,17

* zonas de soldadura separada

Los manguitos AM SDR17 pueden ser soldados en tuberías SDR17 a SDR33

UB PN25 - MANGUITOS SIN TOPE, SDR 7,4

Máxima presión de trabajo permitida 25 bar (agua)

Ref.	Ø	Ud./Caja	€/Ud.
616270	90	30	10,99
616271	110	24	21,38
616272	125	16	24,25
616273	140	12	105,01
616274	160	8	129,74
616282	180	6	130,27
616283	200	2	140,39
616284	225	1	156,18
616285	250	1	210,32
616287	315*	1	460,11
616288	355*	1	501,20

* zonas de soldadura separada

Los manguitos UB SDR7,4 pueden ser soldados en tuberías SDR7,4 a SDR11

Consultar pedido mínimo en manguitos UB SDR 9 y SDR 7,4



Aplicación



REM - MANGUITOS DE TRANSICIÓN RELINING

PE 100 SDR17 Presión de servicio máxima admisible 10 bar (agua)/5 bar (gas)

Ref.	Ø	Ud./Caja	€/Ud.
615569	110/100	24	138,27
615571	160/150	12	250,50
615576	315/300	1	989,51

Con código de barras de precalentamiento

Los manguitos REM pueden ser soldados en tuberías SDR17 a SDR17,6



Aplicación



MV - MANGUITOS DE CIERRE - TAPONES

PE 100 SDR11 - Máxima presión de trabajo permitida 16 bar (agua) / 10 bar (gas)

Ref.	Ø	Ud./Caja	€/Ud.
612025	20	40	5,51
612026	25	40	5,60
612027	32*	40	5,90
612028	40*	25	7,23
612029	50	20	10,24
612030	63	15	10,50
612031	75	20	20,69
612032	90	16	23,74
612033	110	12	29,09
612034	125	16	42,94
612035	160	10	56,73
616183	180	6	135,30
616184	200	4	174,08
616185	225	4	251,88

* También recomendado para sellar los extremos de accionamiento de las cuchillas de corte de las tomas en carga FRIALEN DAA/DAP ≤ d63.

Los tapones MV pueden ser soldados en tuberías SDR11 a SDR17,6

Espesor mínimo de tubo a soldar: 3.0 mm



Aplicación



MR - MANGUITOS DE REDUCCIÓN

Máxima presión de trabajo permitida 16 bar (agua) / 10 bar (gas)

Ref.	Ø	Ud./Caja	€/Ud.
616824	20-16	70	5,83
616452	32-16	70	6,78
615386	32-20	80	7,42
615502	32-25	70	6,95
615387	40-20	60	8,91
616751	40-25	120	7,07
615388	40-32	50	13,06
612069	50-20	32	13,96
616752	50-25	130	8,76
612070	50-32	32	9,32
612071	50-40	25	7,86
615389	63-32	18	9,58
615390	63-40	16	9,58
612072	63-50	16	9,58
616583	75-63	15	19,02
615391	90-50	15	21,78
615392	90-63	15	19,80
616582	90-75	15	22,93
615393	110-63	10	23,00
615693	110-90	8	23,28
615694	125-90	8	28,70
616510	125-110	16	53,33
615695	160-110	8	45,19
616511	180-125	1	80,21
616356	225-160	1	133,80

Las reducciones MR pueden ser soldadas en tuberías SDR11 a SDR17,6

Espesor mínimo de tubo a soldar: 3.0 mm



Aplicación



WS11° - CODOS 11° M/H

PE 100 SDR11 Presión de servicio máxima admisible 16 bar (agua)/10 bar (gas)

Ref.	Ø	Ud./Caja	€/Ud.
616139	110	8	34,16
616140	125	5	46,60
616141	160	8	89,32
616142	180	4	115,70
616143	225	1	199,57

Los codos WS 11 ° pueden ser soldados en tuberías SDR11 a SDR17,6

Espesor mínimo de tubo a soldar: 3.0 mm



Aplicación



W30° - CODOS 30°

PE 100 SDR11 Presión de servicio máxima admisible 16 bar (agua)/10 bar (gas)

Ref.	Ø	Ud./Caja	€/Ud.
615272	90	8	28,24
615273	110	6	40,36
615274	125	4	54,69
615340	160	5	105,65
616261	180	3	133,93
616262	200	1	184,22
616263	225	1	226,04

Los codos W 30° pueden ser soldados en tuberías SDR11 a SDR17,6



Aplicación



W45° - CODOS 45°

PE 100 SDR11 Presión de servicio máxima admisible 16 bar (agua)/10 bar (gas)

Ref.	Ø	Ud./Caja	€/Ud.
616687	25	150	7,83
612092	32	45	7,70
612094	40	25	9,62
612096	50	20	10,92
612098	63	10	11,08
612100	75	14	20,36
612102	90	8	23,68
612104	110	10	33,70
612106	125	10	54,08
615275	160	4	83,77
615687	180	3	89,71
616264	200	1	207,35
615688	225	1	161,66

Los codos W 45 ° pueden ser soldados en tuberías SDR11 a SDR17,6



Aplicación



W45° XL - CODOS 45° XL

PE 100 SDR11 Presión de servicio máxima admisible 16 bar (agua)/10 bar (gas)

Ref.	Ø	Ud./Caja	€/Ud.
616404	250	1	813,99
616405	280	1	985,90
616406	315	1	1.303,19

Los codos W 45 ° XL pueden ser soldados en tuberías SDR11 a SDR17,6



Aplicación



W90° XL - CODO 90° XL

PE 100 SDR11 Presión de servicio máxima admisible 16 bar (agua)/10 bar (gas)

Ref.	Ø	Ud./Caja	€/Ud.
616408	250	1	818,84
616409	280	1	985,90
616410	315	1	1.303,19

Los codos W 90 ° XL pueden ser soldados en tuberías SDR11 a SDR17,6



Aplicación



W90° - CODOS 90°

PE 100 SDR11 Presión de servicio máxima admisible 16 bar (agua)/10 bar (gas)

Ref.	Ø	Ud./Caja	€/Ud.
616686	20	200	7,35
612091	25	60	7,39
612093	32	45	7,41
612095	40	25	7,85
612097	50	20	11,79
612099	63	8	11,06
612101	75	12	19,37
612103	90	6	21,56
612105	110	10	31,19
612107	125	8	50,27
615276	160	3	83,67
615689	180	3	95,79
616265	200	2	195,67
615690	225	1	234,82

Los codos W 90 ° pueden ser soldados en tuberías SDR11 a SDR17,6



Aplicación



TA RED - TÉS REDUCIDAS

PE 100 SDR11 Presión de servicio máxima admisible 16 bar (agua)/10 bar (gas)

Ref.	Ø	Ud./Caja	€/Ud.
616417	32- 20	30	9,23
616418	40- 32	20	12,78
616419	50- 32	10	16,30
616420	50- 40	10	15,73
616421	63- 32	10	17,64
616422	63- 40	10	18,52
616423	63- 50	10	18,69

Las tés TA red pueden ser soldadas en tuberías SDR11 a SDR17,6



Aplicación



TA - TÉS CON DERIVACIÓN EXTRA LARGA

PE 100 SDR11 Presión de servicio máxima admisible 16 bar (agua)/10 bar (gas)

Ref.	Ø	Ud./Caja	€/Ud.
616685	20	200	8,39
616338	25	40	8,49
615719	32	30	8,59
615720	40	20	12,08
615721	50	10	13,61
615722	63	10	14,27

Las tés TA red pueden ser soldadas en tuberías SDR11 a SDR17,6
Espesor mínimo de tubo a soldar: 3.0 mm



Aplicación



T - TÉS DE TRES BOCAS Y DOS SOLDADURAS

PE 100 SDR11 Presión de servicio máxima admisible 16 bar (agua)/10 bar (gas)

Ref.	Ø	Ud./Caja	€/Ud.
612165	75	8	27,84
612166	90	10	46,91
612167	110	6	46,55
612168	125	5	65,82
615277	160	3	110,34
615691	180	2	165,71
616266	200	1	215,81
615692	225	1	235,45

Las tes T pueden ser soldadas en tuberías SDR11 a SDR17,6



Aplicación



T XL - TÉS XL

PE 100 SDR11 Presión de servicio máxima admisible 16 bar (agua)/10 bar (gas)

Ref.	Ø	Ud./Caja	€/Ud.
616412	250*	1	1.157,78
616413	280*	1	1.443,36
616414	315*	1	1.920,63

*Pieza conformada por cuerpo inyectado y dos manguitos bifilares soldados en uno de sus extremos. Para alternativa de inyectado + 3 manguitos utilizar precios de Ref.s TEPE11000250, TEPE11000280 Y TEPE11000315 dela familia de Inyectados y las 612675,615073 y 612670 de Electrosoldables. Las tés T XL pueden ser soldadas en tuberías SDR11 a SDR17,6



Aplicación



Y - PIEZAS EN Y DE PE 100 SDR11

PE 100 SDR11 Presión de servicio máxima admisible 16 bar (agua)/10 bar (gas)

Ref.	Ø	Ud./Caja	€/Ud.
640034	32-32-40	28	37,95
640036	40-40-50	18	41,23



Aplicación



TE RED - XL - TÉS REDUCIDA XL

PE 100 SDR11 Presión de servicio máxima admisible 16 bar (agua)/10 bar (gas)

Ref.	Ø	Ud./Caja	€/Ud.
616426	250/110	1	1.120,84
616427	250/225	1	1.224,17
616428	280/110	1	1.375,25
616429	280/225	1	1.482,28
616430	315/110	1	1.720,85
616431	315/225	1	1.768,53

*Pieza conformada por cuerpo inyectado y dos manguitos bifilares soldados en uno de sus extremos. Para alternativa de manipulados + 2 manguitos utilizar precios de Ref.s de tés reducidas en capítulo Manipulados y para los manguitos las Ref.s en capítulo Electrosoldables. Las tés T red XL pueden ser soldadas en tuberías SDR11 a SDR17,6



Aplicación



YS - PIEZAS EN YS CON ESPIRALES CALEFACTORAS Y EXTREMO PE 100 SDR11

PE 100 SDR11 Presión de servicio máxima admisible 16 bar (agua)/10 bar (gas)

Ref.	Ø	Ud./Caja	€/Ud.
640035	32-32-40	28	31,77
640037	40-40-50	18	36,00

Las Y y las YS pueden ser soldadas en tuberías SDR11 a SDR17,6



USTR - TRANSICIONES PE-AD/ACERO

PE 100 SDR11 Presión de servicio máxima admisible 10 bar (gas)

Ref.	Ø	Ud./Caja	€/Ud.
612780	32/25	15	44,08
612781	40/32	10	49,38
612782	50/40	8	61,17
612783	63/50	6	75,56
612789	75/65	4	172,39
612784	90/80	1	244,37
612785	110/100	1	249,42
612786	125/100	1	298,10
612787	160/150	1	443,97
615030	180/150	1	598,92
612795	200/200	1	677,95
612370	225/200	1	787,63

Otras dimensiones de rosca, o modelos, bajo consulta.
Las USTR pueden ser soldadas en tuberías SDR11 a SDR17,6



USTRS - TRANSICIONES PE-AD/ACERO (PARA SOLDAR CON MANGUITOS)

PE 100 SDR11 Presión de servicio máxima admisible 10 bar (gas)

Ref.	Ø	Ud./Caja	€/Ud.
616632	20/15	21	27,80
616633	25/20	21	30,89
616634	32/25	18	34,13
616635	40/32	12	39,02
616636	50/40	8	44,35
616637	63/50	6	58,56
616638	75/65	2	106,22
616639	90/80	2	108,31
616640	110/100	2	159,63
616641	125/100	2	166,93
616642	140/125	1	232,94
616643	160/150	1	383,62
616644	180/150	1	387,25
616645	200/200	1	564,16
616646	225/200	1	572,45
616647	250/250	1	1.117,37
616648	280/250	1	1.187,95
616649	315/300	1	1.748,74
616650	355/300	1	1.905,27
616651	400/400	1	3.934,36
616652	500/500	1	8.072,25
616653	630/600	1	13.639,31

Otras dimensiones de rosca, o modelos, bajo consulta.
Las USTRS pueden ser soldadas en tuberías SDR11 a SDR17,6



UFLG - TRANSICIONES PARA GAS LICUADO EN PE-AD/COBRE

PE 100 SDR11 Presión de servicio máxima admisible 5 bar (gas)

Ref.	Ø	Ud./Caja	€/Ud.
615733	32-20	25	84,25

Las UFLG pueden ser soldadas en tuberías SDR11 a SDR17,6



USTN - MANGUITOS DE TRANSICIÓN PE-AD/ACERO (ROSCA MACHO)

PE 100 SDR11 Presión de servicio máxima admisible 5 bar (gas)

Ref.	Ø	Ud./Caja	€/Ud.
612580	32-1"	20	30,51
612582	40-1 ¼"	20	39,87
612584	50-1 ½"	15	50,28
612586	63-2"	10	65,64

Otras dimensiones de rosca,, bajo consulta.
Las transiciones USTN pueden ser soldadas en tuberías SDR11 a SDR17,6
Espesor mínimo de tubo a soldar: 3.0 mm



USTM - MANGUITOS DE TRANSICIÓN PE-AD/ACERO (ROSCA HEMBRA)

PE 100 SDR11 Presión de servicio máxima admisible 5 bar (gas)

Ref.	Ø	Ud./Caja	€/Ud.
612570	32-1"	20	32,23
612572	40-1 ¼"	20	43,18
612574	50-1 ½"	15	52,74
612576	63-2"	10	71,22

Otras dimensiones de rosca,, bajo consulta.
Las transiciones USTM pueden ser soldadas en tuberías SDR11 a SDR17,6
Espesor mínimo de tubo a soldar: 3.0 mm



Aplicación



WUSTN 90° - CODOS DE TRANSICIÓN 90° UNIÓN PE-AD/ACERO (ROSCA MACHO)

PE 100 SDR11 Presión de servicio máxima admisible 5 bar (gas)

Ref.	Ø	Ud./Caja	€/Ud.
612602	40-1 ¼"	15	77,29
612604	50-1 ½"	10	61,54
612606	63-2"	10	80,40

Otras dimensiones de rosca, bajo consulta.

Las transiciones WUSTN pueden ser soldadas en tuberías SDR11 a SDR17,6

Espesor mínimo de tubo a soldar: 3.0 mm



Aplicación



WUSTM 90° - CODOS DE TRANSICIÓN 90° UNIÓN PE-AD/ACERO (ROSCA HEMBRA)

PE 100 SDR11 Presión de servicio máxima admisible 5 bar (gas)

Ref.	Ø	Ud./Caja	€/Ud.
612610	32-1"	20	33,49
612611	40-1"	15	62,67
612612	40-1 ¼"	15	75,40
612614	50-1 ½"	10	56,36
612616	63-2"	10	78,20

Otras dimensiones de rosca, o modelos, bajo consulta.

Las transiciones WUSTM pueden ser soldadas en tuberías SDR11 a SDR17,6

Espesor mínimo de tubo a soldar: 3.0 mm



Aplicación



MUN - MANGUITOS DE TRANSICIÓN UNIÓN PE-AD/LATÓN (ROSCA MACHO HEXAGONAL)

PE 100 SDR11 Presión de servicio máxima admisible 16 bar (agua)

Ref.	Ø	Ud./Caja	€/Ud.
612712	32-1"	20	25,39
612709	32-1 ¼"	20	37,61
612698	32-1 ½"	15	39,67
612721	40-1"	20	37,59
612713	40-1 ¼"	20	32,11
612718	40-1 ½"	20	43,22
612725	40-2"	20	74,45
612719	50-1"	15	50,43
612716	50-1 ¼"	15	49,06
612714	50-1 ½"	15	40,59
612706	50-2"	15	56,40
612722	63-1 ¼"	10	81,58
612717	63-1 ½"	10	71,97
612715	63-2"	10	60,21
612694	75-2"	10	140,96
612695	75-2 ½"	10	140,59

Estándar: latón. Otros materiales bajo consulta.

Otras dimensiones de rosca, bajo consulta.

Las transiciones MUN pueden ser soldadas en tuberías SDR11 a SDR17,6

Espesor mínimo de tubo a soldar: 3.0 mm



Aplicación



MUM - MANGUITOS DE TRANSICIÓN UNIÓN PE-AD/FUNDICIÓN (ROSCA HEMBRA HEXAGONAL)

PE 100 SDR11 Presión de servicio máxima admisible 16 bar (agua)

Ref.	Ø	Ud./Caja	€/Ud.
612595	32-1"	20	37,61
612596	40-1 ¼"	20	52,43
612692	50-1 ½"	15	63,45
612708	63-1 ½"	10	149,50
612693	63-2"	10	96,88

Estándar: latón. Otros materiales bajo consulta.

Otras dimensiones de rosca, bajo consulta.

Las transiciones MUM pueden ser soldadas en tuberías SDR11 a SDR17,6

Espesor mínimo de tubo a soldar: 3.0 mm



Aplicación



UAM ET - MANGUITOS DE TRANSICIÓN PE-AD / LATÓN CON TUERCA MÓVIL Y ROSCA HEMBRA

PE 100 SDR11 Presión de servicio máxima admisible 16 bar (agua)

Ref.	Ø	Ud./Caja	€/Ud.
616654	25-¾"	100	46,00
616655	32-1"	60	54,13
616626	40-1 ¼"	35	68,67
616627	50-1 ½"	30	77,90
616628	63-2"	20	107,63
616629	63-1 ½"	20	96,98

Otras dimensiones de rosca, bajo solicitud.

Estándar: latón, acero bajo consulta

La junta de sellado no está incluida



Aplicación



WUN 90° - CODOS DE TRANSICIÓN PE-AD/ LATÓN (ROSCA MACHO HEXAGONAL)

PE 100 SDR11 Presión de servicio máxima admisible 16 bar (agua)

Ref.	Ø	Ud./Caja	€/Ud.
612120	32-1"	20	28,91
612140	32-1 ½"	20	41,80
612127	40-1"	15	39,16
612122	40-1 ¼"	15	43,78
612121	40-1 ½"	15	44,88
612119	50-1"	10	51,40
612123	50-1 ¼"	10	50,60
612124	50-1 ½"	10	42,02
612125	63-1 ½"	10	75,40
612126	63-2"	10	71,23

Estándar: latón. Otros materiales bajo consulta.

Otras dimensiones de rosca, bajo consulta.



Aplicación



UAN - TRANSICIONES ADAPTADOR MACHO PE-AD/LATÓN

PE 100 SDR11 Presión de servicio máxima admisible 16 bar (agua)/5 bar (gas)

Ref.	Ø	Ud./Caja	€/Ud.
616604	20-½"	100	13,03
616605	25-¾"	100	16,56
616152	32-1"	60	24,80
616153	40 - 1 ¼"	35	34,03
616154	50-1 ½"	30	34,88
616610	63-1 ½"	20	49,10
616155	63-2"	20	44,71
616612	75-2 ½"	14	85,57
616613	90-3"	6	106,66
616614	110-4"	4	180,36
616664	125-4"	4	199,86

Otras dimensiones de rosca,, bajo consulta.



Aplicación



UAM - TRANSICIONES ADAPTADOR HEMBRA PE-AD/LATÓN

PE 100 SDR11 Presión de servicio máxima admisible 16 bar (agua)/5 bar (gas)

Ref.	Ø	Ud./Caja	€/Ud.
616615	20-½"	150	10,14
616616	25-3/2"	100	16,53
616156	32-1"	60	19,33
616157	40-1 ¼"	50	28,43
616158	50-1 ½"	35	32,49
616621	63-1 1/2"	20	41,29
616159	63 - 2"	20	41,13
616665	75-2 ½"	14	77,11
616623	90-3"	10	86,30
616624	110-4"	6	160,09
616666	125-4"	6	165,46

Otras dimensiones de rosca,, bajo consulta.



Aplicación



Aplicación



EFL - PORTABRIDAS EMBRIDADAS
PE 100 SDR11 Presión de servicio máxima admisible 16 bar (agua)/5 bar (gas)

Ref.	Ø	Ud./Caja	€/Ud.
615417	63/50	5	86,40
615418	90/80	5	94,84
615419	110/100	3	105,29
615605	125/100	2	120,44
615421	160/150	2	182,63
615927	180/150	2	213,66
615607	225/200*	1	261,89

* Agujeros de brida para PN 10

RS -XL - ABRAZADERAS DE REPARACIÓN
PE 100 SDR11 Presión de servicio máxima admisible 16 bar (agua)/10 bar (gas)

Ref.	Ø	Ud./Caja	€/Ud.
616366	500	1	4.927,22
616367	560	1	5.214,70
616368	630	1	5.387,96
616369	710	1	5.586,27
616370	800	1	5.947,43
616371	900	1	6.278,31
616372	1000	1	6.460,96
616379	1200	1	6.772,00



Aplicación



SA - TOMAS SIMPLES

PE 100 SDR11 Presión de servicio máxima admisible 16 bar (agua)/10 bar (gas)

Ref.	Ø	Ud./Caja	€/Ud.
612757	63-32*	20	37,02
612759	63-50*	20	32,94
615020	75-50	15	39,31
615285	90-32	20	44,10
612819	90-63	20	39,52
615334	110-32	12	48,09
615031	110-50	12	45,28
612760	110-63	12	43,92
615411	110-90	12	68,82
615087	125-32	12	54,07
612761	125-63	12	50,51
615412	125-90	12	52,25
615584	125-110	10	62,11
612886	160-32	8	115,20

Ref.	Ø	Ud./Caja	€/Ud.
612762	160-63	6	96,90
615413	160-90	2	93,28
615739	160-110	2	105,16
615585	160-125	2	98,16
612763	180-63	6	59,67
615414	180-90	2	104,15
615948	180-110	2	106,21
615740	180-125	2	103,39
612764	200-63	5	56,17
612765	225-63	5	57,74
615415	225-90	5	101,55
616044	225-110	5	112,14
616045	225-125	4	124,05
616046	225-160	4	112,85

Las tomas simples SA pueden ser soldadas en tuberías SDR11 a SDR17,6

*Excepto las Ø 63 que solo pueden serlo con SDR11



Aplicación



SA-TL - TOMA SIMPLE SA-TL

PE 100 SDR11 Presión de servicio máxima admisible 16 bar (agua)/10 bar (gas)

Ref.	Ø1	Ø2	Ø3	Ud./Caja	€/Ud.
615465	250/560	32	21	5	90,86
615466	250/560	63	47	5	100,16

Las tomas simples SA-TL pueden ser soldadas en tuberías SDR11 a SDR17,6



Aplicación



SA-XL - TOMA SIMPLE SA-XL

PE 100 SDR11 Presión de servicio máxima admisible 16 bar (agua)/10 bar (gas)

Ref.	Ø1	Ø2	Ud./Caja	€/Ud.
616469	400	225	1	7.859,75
616779	400	250	1	8.261,28
616780	450	225	1	7.216,60
616781	450	250	1	6.766,90
616391	500	225	1	6.897,00
616782	500	250	1	7.188,97
616783	500	280	1	7.515,16
616784	500	315	1	7.723,93
616392	560	225	1	6.304,38
616785	560	250	1	6.304,38
616786	560	280	1	6.304,38
616787	560	315	1	6.304,38
616788	560	355	1	6.721,90
616789	560	400	1	8.141,44
616393	630	225	1	6.408,77
616790	630	250	1	6.408,77
616791	630	280	1	6.408,77
616792	630	315	1	6.408,77
616793	630	355	1	6.813,47
616794	630	400	1	8.308,43
616394	710	225	1	6.554,89
616795	710	250	1	6.554,89
616796	710	280	1	6.554,89
616797	710	315	1	5.899,40
616798	710	355	1	6.275,16
616762	710	400	1	8.350,18
616395	800	225	1	6.554,89
616799	800	250	1	6.659,29
616800	800	280	1	6.659,29
616801	800	315	1	6.659,29

Ref.	Ø1	Ø2	Ud./Caja	€/Ud.
616802	800	355	1	7.076,80
616803	800	400	1	8.767,69
616396	900	225	1	6.926,48
616804	900	250	1	6.784,55
616805	900	280	1	6.784,55
616806	900	315	1	6.784,55
616807	900	355	1	7.306,41
616808	900	400	1	9.602,72
616397	1000	225	1	6.554,89
616809	1000	250	1	6.972,41
616810	1000	280	1	6.972,41
616811	1000	315	1	7.494,29
616812	1000	355	1	7.911,80
616813	1000	400	1	10.020,22
616384	1200	225	1	7.306,41
616814	1200	250	1	7.306,41
616815	1200	280	1	7.306,41
616816	1200	315	1	7.807,41
616817	1200	355	1	8.350,18
616818	1200	400	1	10.855,23

PE 100 SDR17 Presión de servicio máxima admisible 10 bar (agua)/5 bar (gas)

Ref.	Ø1	Ø2	Ud./Caja	€/Ud.
616378	1000	160	1	6.179,14
616383	1200	160	1	6.596,64

* Para otras dimensiones consultar SA UNI



Aplicación



SA-TL UNI- TOMAS SIMPLES SA-UNI

PE 100 SDR11 Presión de servicio máxima admisible 16 bar (agua)/10 bar (gas)

Ref.	Ø1	Ø2	Ud./Caja	€/Ud.
616553	250-280	90	5	151,05
616554	250-280	110	5	164,45
616555	250-280	125	5	175,57
616556	250-280	160	5	160,24
616557	315-400	90	5	162,74
616558	315-400	110	5	155,39
616559	315-400	125	5	184,69
616560	315-400	160	5	150,34
616561	450-900	90	5	172,23
616562	450-900	110	5	159,06
616563	450-900	125	5	201,53
616564	450-900	160	5	185,71

Las tomas simples SA-TL-UNI pueden ser soldadas en tuberías SDR11 a SDR17,6



Aplicación



DAA-TL - TOMAS EN CARGA TOP-LOADING CON DERIVACIÓN EXTRA LARGA

PE 100 SDR11 Presión de servicio máxima admisible 16 bar (agua)/10 bar (gas)

Ref.	Ø1	Ø2	Ø3	Ud./Caja	€/Ud.
615527	080/130	50	50	20	187,25
615528	130/160	50	50	12	216,54
615531	160/210	63	50	5	221,29
615339	250/315(400)	63	50	5	310,76

Las tomas en carga DAA-TL pueden ser soldadas en tubos SDR11 a SDR17,6 desde Ø 250 a Ø 315
Para tubos mayores a Ø 315 sólo en SDR17



Aplicación



**DAA - TOMAS EN CARGA
CON DERIVACIÓN EXTRA LARGA**

*PE 100 SDR11 Presión de servicio máxima
admisible 16 bar (agua)/10 bar (gas)*

Ref.	Ø1	Ø2	Ø3	Ud./Caja	€/Ud.
612630	40	20	50	30	45,09
616473	40	25	50	30	45,09
616474	40	32	50	30	41,31
616475	50	20	50	28	58,37
612702	50	25	50	28	56,10
615080	50	32	50	28	56,10
612631	63	20	50	20	59,58
612633	63	25	50	20	59,58
612632	63	32	50	20	47,02
616334	63	63	50	20	59,30
616482	75	32	50	24	68,54
616483	90	20	50	14	75,47
616484	90	25	50	14	69,21
612634	90	32	50	14	58,64
612701	90	63	50	14	61,21
616487	110	20	50	14	68,06
616488	110	25	50	14	68,06
612637	110	32	50	14	66,31
612624	110	63	50	14	64,97
616491	125	20	50	12	90,86
616492	125	25	50	12	90,86
612649	125	32	50	12	90,86
612309	125	63	50	12	85,72
616495	140	32	50	12	114,56
616496	140	63	50	12	118,46
616497	160	20	50	10	80,45
616498	160	25	50	10	80,45
612641	160	32	50	10	78,15
612650	160	63	50	10	78,32
616501	180	20	50	10	90,43
616502	180	25	50	10	90,43
612651	180	32	50	10	90,43
612652	180	63	50	10	90,43
612654	200	32	50	8	96,40
612659	200	63	50	8	92,81
612657	225	32	50	8	130,69
612655	225	63	50	8	130,69

Las tomas en carga DAA pueden ser soldadas en tuberías SDR11 a SDR17,6

*Excepto las ≤ DN 63 que solo pueden serlo con SDR11



Aplicación



DAV - TOMAS EN CARGA CON VÁLVULA DE CORTE INCORPORADA CON DERIVACIÓN EXTRA LARGA

PE 100 SDR11 Presión de servicio máxima admisible 16 bar (agua)/10 bar (gas)

Ref.	Ø1	Ø2	Ud./Caja	€/Ud.
615955	50*	32	16	148,59
615341	63*	32	16	133,65
615342	63*	40	16	141,46
615956	75	32	12	156,20
615344	90	32	12	176,24
615346	90	50	12	178,53
615347	90	63	12	180,58
615348	110	32	10	165,92
615350	110	50	10	167,01
615351	110	63	10	170,26
615352	125	32	10	178,32
615354	125	50	10	178,70
615355	125	63	10	178,91
615930	140	63	6	183,25
615356	160	32	6	211,60
615358	160	50	6	210,55
615359	160	63	6	213,27
615361	180	32	5	213,51
615363	180	50	5	214,33
615364	180	63	5	214,57
615366	200	32	5	212,93
615368	200	50	5	249,54
615369	200	63	5	214,33
615374	225	32	5	211,85
615376	225	50	5	212,89
615377	225	63	5	212,89

Las tomas DAV pueden ser soldadas en tuberías SDR11 a SDR17,6

* Excepto las ≤ DN 63 que solo pueden serlo con SDR11



Aplicación



DAV-TL - TOMAS EN CARGA TOP LOADING CON VÁLVULA DE CORTE INCORPORADA CON DERIVACIÓN EXTRA LARGA

PE 100 SDR11 Presión de servicio máxima admisible 16 bar (agua)/10 bar (gas)

Ref.	Ø1	Ø2	Ud./Caja	€/Ud.
616464	250/315	50	10	256,42
616465	355/400	50	10	269,25

Las tomas DAV-TL pueden ser soldadas en tuberías SDR11 a SDR17,6



Aplicación



KH - VÁLVULAS DE BOLA EN PE-AD, ¼ DE VUELTA. PASO TOTAL.

PE 100 SDR11 Presión de servicio máxima admisible 16 bar (agua)/10 bar (gas)

Ref.	Ø	Ud./Caja	€/Ud.
616174	20	1	73,11
616175	25	1	81,71
616176	32	1	90,31
616177	40	1	98,92
616178	50	1	184,02
616179	63	1	202,12
616180	90	1	279,53
616181	110	1	335,44
616182	125	1	602,05



KHP-GAS - VÁLVULAS DE BOLA EN PE-AD, ¼ DE VUELTA PARA GAS. PASO REDUCIDO.

PE 100 SDR11 Presión de servicio máxima admisible 10 bar (gas)

Ref.	Ø	Ud./Caja	€/Ud.
612490GPL	32	1	77,22
612494GPL	63	1	170,69
612495GPL	90	1	248,57



Aplicación



KHP - VÁLVULAS DE BOLA EN PE-AD, ¼ DE VUELTA. PASO REDUCIDO.

PE 100 SDR11 Presión de servicio máxima admisible 16 bar (agua)/10 bar (gas)

Ref.	Ø	Ud./Caja	€/Ud.
612490	32	1	67,25
612497	40	1	85,89
612492	50	1	125,22
612494	63	1	149,06
612495	90	1	207,12
612493	110	1	268,33
612496	125	1	478,51
612483	160	1	787,15
615309	180	1	894,48
612480	200	1	930,20
616186	225	1	1.341,70



Aplicación



KHPV-GAS - VÁLVULAS DE ESFERA EN PE-AD, ¼ DE VUELTA, CON VENTEOS, PARA GAS. PASO REDUCIDO.

PE 100 SDR11 Presión de servicio máxima admisible 10 bar (gas)

Ref.	Descripción	Ø - Venteos	Ud./Caja	€/Ud.
KHP0VE063GPL	Sin venteos	63-0VE	1	264,35
KHP1VE063GPL	Con un venteo	63-1VE	1	632,98
KHP2VE063GPL	Con dos venteos	63-2VE	1	952,00



Aplicación



BS - SETS DE ACCIONAMIENTO PARA KH,KHP, AKHP Y AKHP-TL

PE 100 SDR11 Presión de servicio máxima admisible 16 bar (agua)/10 bar (gas)

Ref.	Ø Tubo	Longitud (mm)	Ud./Caja	€/Ud.
615741	20-50	0,45 - 0,70	1	101,83
615957	20-50	0,60 - 1,00	1	110,26
615328	20-50	0,60 - 1,00	1	104,66
616466	20-50	1,00 - 1,50	1	117,79
615330	20-50	1,00 - 1,50	1	113,06
616068	20-50	1,20 - 2,00	1	117,70
615329	20-50	1,20 - 2,00	1	115,78
615958	63-225	0,60 - 1,00	1	124,26
615310	63-225	0,60 - 1,00	1	117,61
616467	63-225	1,00 - 1,50	1	129,31
615331	63-225	1,00 - 1,50	1	127,04
616069	63-225	1,20 - 2,00	1	140,59
615311	63-225	1,20 - 2,00	1	139,69

Máquinas de soldadura
Rascadores
Accesorios y herramientas

Equipos y herramientas

Friatools

INFRAESTRUCTURA





FRIAMAT BASIC ECO
MÁQUINA UNIVERSAL DE SOLDADURA
SIN FUNCIÓN DE DOCUMENTACIÓN

Ref.	Descripción	€/Ud.
613120	Friamat basic eco con lápiz lector de código de barras	3.394,41
614120	FRIAMAT basic eco 2D	4.160,24
611120 ●	Friamat basic eco con mini escáner lector de código de barras	3.561,55

Unidad de fusión universal para la unión de accesorios de DN 20 a DN 710. Compartimento de almacenamiento para accesorios, opción de lector código de barras o escáner para el reconocimiento de códigos de barras. Teclado de fácil manejo. Selección de idiomas, volumen de timbre ajustable, e introducción manual de notas.

Cable de conexión (4 m) y cable de red (5 m) extra largos. Peso aproximado 18 kg.

Suministrado en una práctica caja de aluminio de protección para el transporte.



FRIAMAT PRIME ECO
MÁQUINA UNIVERSAL DE
SOLDADURA CON FUNCIÓN DE
DOCUMENTACIÓN Y TRAZABILIDAD

Ref.	Descripción	€/Ud.
613124	Friamat prime eco con lápiz lector de código de barras	3.502,25
614124	FRIAMAT prime eco 2D	4.258,05
611124	Friamat prime eco con mini escáner lector de código de barras	3.669,40

Unidad de fusión para la soldadura mediante accesorios de electrofusión de tubos de cualquier tamaño (hasta DN 900). Fácil guía de usuario con un gran display, maxi-guía y modernos interfaces: Puertos USB (A + B) para la transmisión de datos a través de tarjeta de memoria FRIATEC (incluida); para la conexión de impresoras, volcado de datos y de documentos PDF.

Puerto paralelo para conexión a impresora y PC.

Contraseña de supervisor para el ajuste individual de las funciones del dispositivo.

Posibilidad de introducir coordenadas GPS, e introducir información a través de textos de código de barras, con lápiz lector o escáner de código de barras (opcional).

Selección de idiomas, volumen de timbre ajustable, e introducción manual de notas. Cable de conexión (4 m) y cable de red (5 m) extra largos.

Peso aproximado 18 kg.

Suministrado en una práctica caja de aluminio de protección para el transporte.

App en castellano disponible

AVAILABLE ON THE
Google Play

AVAILABLE ON THE
App Store





FRIAMAT PRINT ECO
MÁQUINA UNIVERSAL DE SOLDADURA
CON FUNCIÓN DE DOCUMENTACIÓN

Ref.	Descripción	€/Ud.
613122	Friamat print eco con lápiz lector de código de barras	3.243,07
611122	Friamat print eco con mini escáner lector de código de barras	3.366,48

Unidad de fusión universal para la unión de accesorios de DN20 a DN1200.

Puerto USB para la transmisión de datos para la conexión a impresora de datos y de documentación PDF

Selección de idiomas, volumen de timbre ajustable e introducción manual de notas. Cable de conexión (4 m) y cable de red (5 m) extra largos.

Peso aproximado 18 kg.

Suministrada en una práctica caja de aluminio de protección para el transporte



FRIAMAT 7 PRIME

Ref.	Descripción	€/Ud.
613134	FRIAMAT 7 Gen. prime	4.192,10
611134	FRIAMAT 7 Gen. prime Mini Escaner	4.359,27
614134	FRIAMAT 7 Gen. prime 2D	4.957,93

FRIAMAT prime ofrece una gran cantidad de funciones digitales para la documentación y la trazabilidad, gracias a la nueva interfaz Bluetooth en combinación con la aplicación FRIAMAT. Con el escáner 1D/2D opcional, la nueva generación de FRIAMAT también está preparada para leer y procesar códigos de barras 2D según ISO 12176-5. Su pantalla de alto brillo y contraste es fácil de leer, tanto en días soleados como en días oscuros y lluviosos. Convierte tu teléfono en el centro de control de todo lo relacionado con la soldadura. Simplemente conecta tu unidad FRIAMAT prime a la aplicación FRIAMAT APP a través de Bluetooth. Después podrás controlar el proceso de fusión con tu teléfono. Los datos del proceso de fusión se transfieren automáticamente a la aplicación.



FRIAMAT 7 PRIME

Ref.	Descripción	€/Ud.
613130	FRIAMAT 7 Gen. Basic	4.099,72
611130	FRIAMAT 7 Gen. basic Mini Escaner	4.266,86
614130	FRIAMAT 7 Gen. basic 2D	4.865,55

FRIAMAT basic es nuestro modelo básico por excelencia, cada vez con más prestaciones: refrigeración activa con flujo optimizado, carcasa robusta, pantalla gráfica de alta calidad, interfaz de usuario intuitiva y mucho más.



NUEVO ESCÁNER LECTOR DE CÓDIGOS DE BARRAS

Ref.	Descripción	€/Ud.
624005	Mini escáner	606,63



FWLESST - LÁPIZ LECTOR DE CÓDIGO DE BARRAS

Ref.	Descripción	€/Ud.
623645	Lápiz lector	424,54

Lápiz lector de códigos de barras FRIAMAT apto para leer los códigos de soldadura y de trazabilidad.
Apto para todos los equipos de soldadura FRIAMAT.



CONTACT 4 - BORNES DE CONEXIÓN DE 4,0 MM

Ref.	Descripción	€/Par.
624529	Bornes de 4,0 mm	94,10

Para la conexión al accesorio de soldadura en toda nuestra gama FRIAMAT.
Estos conectores se venden por unidad.



ADBK - ADAPTADORES PARA BORNES DE 4,7 MM

Ref.	Descripción	€/Par
613237	Adaptadores de bornes	180,39

Adaptador para bornes de 4,7 mm para cualquier tipo de FRIAMAT.
Estos conectores se venden por pares.



ALTK (FMT) - CAJA DE ALUMINIO PARA TRANSPORTE

Ref.	Descripción	€/Ud.
627600	Caja de transporte para nuevas FRIAMAT prime / basic	521,17
627001	Caja de transporte para antiguas FRIAMAT prime / basic	521,17
627001	Caja de transporte para FRIAMAT prime eco / basic eco	521,17
613302	Caja de transporte para FRIAMAT XL	642,18

Para el transporte y el almacenamiento de equipos de soldadura FRIAMAT. Otras cajas de transporte para equipos más antiguos FRIAMAT (I-II) bajo consulta.



FWSG 63 - RASCADOR PARA TUBOS DESDE DN 20 HASTA DN 63

Ref.	Descripción	€/Ud.
613408	Rascador para tubos DN 20 a DN 63	1.800,05

Para eliminar de forma segura la capa de óxido de las tuberías de HDPE y PE-XA.
Cuchilla extra ancha de metal duro.
Incluye 1 cuchilla de repuesto.
Suministrado en una práctica caja de aluminio de protección para el transporte.



FWSG 225 - RASCADOR PARA TUBOS DESDE DN 75 HASTA DN 400

Ref.	Descripción	€/Ud.
613410	Rascador para tubos DN 75 a DN 400	2.527,86

Para eliminar de forma segura la capa de óxido de las tuberías de HDPE y PE-XA.
Cuchilla extra ancha de metal duro.
Incluye 1 cuchilla de repuesto.
Suministrado en una práctica caja de aluminio de protección para el transporte.



FWSG 710 L - RASCADOR PARA TUBOS DESDE DN 250 HASTA DN 710

Ref.	Descripción	€/Ud.
613642	Rascador para tubos DN 250 a DN 710	4.573,11

Para eliminar de forma segura la capa de óxido de las tuberías de HDPE y PE-Xa a la mitad o completo. Rascador de gran longitud. Cuchilla con hoja de carburo para una larga duración y raspado uniforme. Suministrado en una práctica caja de aluminio de protección para el transporte



FWSG 710 S - RASCADOR PARA TUBOS DESDE DN 250 HASTA DN 710 Y ACCESORIOS A TOPE

Ref.	Descripción	€/Ud.
613639	Rascador para tubos DN 250 a DN 710 y accesorios a tope	4.573,11

Para eliminar de forma segura la capa de óxido de las tuberías de HDPE y PE-Xa a la mitad o completo y para el raspado seguro de piezas y tubos que van a ser soldados a testa.

Rascador de gran longitud. Cuchilla con hoja de carburo para una larga duración y raspado uniforme. Suministrado en una práctica caja de aluminio de protección para el transporte.



WSG 900 L - RASCADOR PARA TUBOS DESDE DN 630 HASTA DN 900

Ref.	Descripción	€/Ud.
613644	Rascador para tubos desde DN 630 a DN 900	10.281,39

Para eliminar de forma segura la capa de óxido de las tuberías de HDPE y PE-Xa a la mitad o completo y para el raspado seguro de piezas y tubos que van a ser soldados a testa.

Rascador de gran longitud. Cuchilla con hoja de carburo para una larga duración y raspado uniforme.

Suministrado en una práctica caja de aluminio de protección para el transporte.

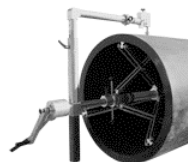

FWSG XL - RASCADOR PARA TUBOS DESDE DN 800 HASTA DN 1200

Ref.	Descripción	€/Ud.
613645	Rascador para tubos DN 800 a DN 1200	25.298,06

Para eliminar de forma segura la capa de óxido en las tuberías de PE-AD en diámetros desde 800 a 1200, SDR11 - SDR33. Diseño modular para un fácil manejo y rápida instalación. Ajuste rápido y seguro al ancho del tubo. Montaje central, accionamiento mediante manivela. Compensación automática de la ovalidad de tubería y tolerancias mediante una cuchilla alojada en muelle móvil.

Cuchilla reversible para doblar la duración.

Suministrado en una práctica caja de aluminio de protección para el transporte.

**FWSG 63 - RASCADOR PARA TUBOS DESDE DN 63 A DN 315**

Ref.	Ø	Descripción	€/Ud.
613562	DN 63	FWSG SE 63	1.573,03
613563	DN 75	FWSG SE 75	1.608,89
613564	DN 90	FWSG SE 90	1.663,83
613565	DN 110	FWSG SE 110	1.690,35
613566	DN 125	FWSG SE 125	1.864,92
613567	DN 140	FWSG SE 140	1.957,44
613568	DN 160	FWSG SE 160	1.864,92
613569	DN 180	FWSG SE 180	2.114,66
613570	DN 200	FWSG SE 200	2.173,52
613571	DN 225	FWSG SE 225	2.236,84
613572	DN 250	FWSG SE 250	2.331,96
613573	DN 280	FWSG SE 280	2.380,33
613574	DN 315	FWSG SE 315	2.450,78

Rascador para extremos de tubos y tomas simples y en carga. Dimensionado para cada diámetro para un raspado seguro y libre de óxido. Se usa en tuberías PE-AD y PE-XA.

Cuchillas reversibles para doblar la duración. Fácil fijación gracias al diseño de apertura y cierre. Suministrado en una práctica caja de aluminio de protección para el transporte.

**PFSP - SPRAY DE ACEITE PARA EL MANTENIMIENTO DE LOS RASCADORES DE FRIATEC**

Ref.	Descripción	€/Ud.
613301	Spray de mantenimiento FRIATEC	36,33

Para la limpieza y el mantenimiento de rascadores. Contenido 100 ml. Observe con atención las instrucciones de seguridad y utilización indicadas en el recipiente del spray de mantenimiento, y a las pertinentes instrucciones de uso de los rascadores.



FWSG RA - CUCHILLAS DE REPUESTO PARA RASCADORES

Ref.	Descripción	€/Ud.
613322 (1)	FWSGE 3. Cuchillas para FWSG 225/315 Y FWSGA. Pintadas de color rojo	362,60
613323 (1)	FWSGE 4. Cuchillas para FWSG 63. Pintadas de color verde	364,25
613324 (1)	FWSGE 5. Cuchillas para FWSG 710 L/S / FWSG 900 L. Pintadas de color azul	367,31
613325 (2)	FWSGE 6. Cuchillas para FWSGS 110 / FWSGS 180	368,42
613326 (2)	FWSGE 7. Cuchillas para FWSGS 225	370,43

(1) Integrado por 3 unidades de cuchillas de repuesto, 1 tornillo de cabeza de estrella y 1 llave cabeza estrella.

(2) Integrado por 1 unidad de cuchillas de repuesto, 2 tornillos de cabeza de estrella y 1 llave cabeza estrella.



Ref.	Descripción	€/Ud.
613327 (3)	FWSGE 8. Cuchillas para FWSG SE (todos los DN)	251,69

(3) Integrado por 1 unidad de cuchillas de repuesto, 1 tornillo de cabeza de estrella y 1 llave cabeza estrella.



Ref.	Descripción	€/Ud.
613329 (4)	FWSGE 10. Cuchillas para FWSG RA 32 y 40	171,25
613330 (4)	FWSGE 11. Cuchillas para FWSG RA 50 y 63	172,09

(4) Integrado por 1 unidad de cuchillas de repuesto, 1 tornillo de cabeza de estrella y 1 llave cabeza estrella.



Ref.	Descripción	€/Ud.
613331 (5)	FWSGE 12. Cuchillas para FWSG XL	695,04

(5) Integrado por 1 unidad de cuchillas de repuesto, 1 placa de deslizamiento. 2 tornillos de cabeza de estrella y 1 llave cabeza de estrella.

Cuchillas de repuesto de metal duro (alta estabilidad, larga duración)



ALTK (FWSG) - CAJA DE ALUMINIO PARA EL TRANSPORTE DE LOS RASCADORES FRIATEC

Ref.	Descripción	€/Ud.
613307	ALTK FWSG 63	87,86
613309	ALTK FWSG 225 Y 63/225	211,92
613308	ALTK FWSG 710 S	400,46
613314	ALTK FWSG 710 L	400,46
613304	ALTK FWSG 900 L	426,75
613303	ALTK FWSG SE 63	202,58
613319	ALTK FWSG SE 75-140	226,50
613318	ALTK FWSG SE 160	233,51
613320	ALTK FWSG SE 250-315	342,70

Para transportar y almacenar rascadores.



FWZ - RASCADOR MANUAL

Ref.	Descripción	€/Ud.
613300	Rascador manual	38,50
613270	Cuchillas de respuesto 5 uds.	29,15

Para la eliminación de la capa de óxido de las tuberías de PE – AD y accesorios, así como para desbarbar el canto cortado.

Cuchillas de repuesto en pack de 5 uds.



FWZ - RASCADOR MANUAL

Ref.	Descripción	€/Ud.
613299	Rascador manual gran Ø	256,53

Para eliminar la capa de óxido de tubos de PE de gran diámetro, que no pueden ser rascados con rascadores convencionales.

Sirve especialmente para la preparación de las superficies de unión con tomas simples del tipo FRIALEN XL. También es apto para quitar las rebabas de bordes cortados.

Dispone de dos superficies de corte.



FRIATOP - DISPOSITIVO DE FIJACIÓN (TOP LOADING)

Ref.	Descripción	€/Ud.
613350	Dispositivo Top Loading	3.324,41

Dispositivo de fijación, presión y colocación para el montaje de las tomas simples y en carga FRIALEN Top Loading. No requiere fijación inferior. Accionamiento con muelle neumático extra elástico para una óptima presión durante el proceso de fusión.

**PRESSKO - ÉMBOLO PARA LAS TOMAS EN CARGA FRIALEN XL Y SA-XL**

Ref.	Dimensión émbolo	Descripción	€/Ud.
613821	DN 160	Émbolo para FRIALEN SA-XL	536,36
613822	DN 225	Émbolo para FRIALEN SA-XL	676,54
613823	DN 250	Émbolo para FRIALEN SA-XL	778,54
613853	DN 280	Émbolo para FRIALEN SA-XL	1.028,52
613854	DN 315	Émbolo para FRIALEN SA-XL	1.130,90
613855	DN 355	Émbolo para FRIALEN SA-XL	1.198,45
613837	DN 400	Émbolo para FRIALEN SA-XL	2.780,78

Émbolo de fijación y conexión del Vacuset XL con salida DN 160 a DN 400

**FWAB XL - BROCA DE PERFORACIÓN FWAB XL PARA SA-XL**

Ref.	Descripción	DN de la salida	€/Ud.
613832	FWAB XL 90	DN 90	2.299,87
613833	FWAB XL 110	DN 110	2.379,87
613834	FWAB XL 125	DN 125	2.448,44
613829	FWAB XL 160 SDR11	DN 160	2.614,14
613838	FWAB XL 160 SDR17	DN 160	2.914,13
613830	FWAB XL 225	DN 225	2.928,42
613831	FWAB XL 250	DN 250	3.251,25
613850	FWAB XL 280	DN 280	3.931,19
613851	FWAB XL 315	DN 315	4.171,20
613852	FWAB XL 355	DN 355	4.171,20
613836	FWAB XL 400	DN 400	4.190,23

FWAB XL para la perforación de tubos de PE-AD. Con sistema de despresurización a través de la salida de los accesorios SA-XL. Consistente en una sierra cortante del DN elegido, un adaptador SDS max, extensión para el adaptador, broca central y cavidad para alojamiento de la viruta. Se debe utilizar un taladro eléctrico.

Se entrega en un maletín de aluminio.

**UNITOP - DISPOSITIVO DE FIJACIÓN PARA LAS TOMAS SIMPLES SA-UNI**

Ref.	Descripción	€/Ud.
613385	Dispositivo de fijación para tomas simples Frialen SA-UNI	5.713,96
613241	Adaptadores en ángulo para conexiones por socket 4.0 mm	76,58

Dispositivo de fijación para las tomas de derivación simple SA-UNI DN 250 a DN 710 con salidas DN 90, DN110, DN 125 y DN 160. Se suministra en un maletín de aluminio.



CLAMP 63 - ALINEADOR PARA TUBOS DESDE DN 20 HASTA DN 63

Ref.	Descripción	€/Ud.
613020	Alineador para tubos DN 20 a DN63	579,90
613034	Alineador para tubos DN 32 a DN63 para instalación con FRIALONG	917,59

Alineador universal con ajuste de ángulo (45° y 90°), para manguitos, reducciones y salidas en accesorios de toma de derivación electrosoldable desde DN 20 a DN 63.

Opcional: versión CLAMP63L para instalaciones de manguitos extra largos FRIALONG.



CLAMP 180 - ALINEADOR PARA TUBOS DESDE DN 63 HASTA DN 180

Ref.	Descripción	€/Ud.
613021	Alineador con dos elementos fijadores	1425,18
613022	Elemento fijador adicional	284,31
613023	Set de medias lunas reductoras DN 110-DN 160	99,75
613024	Extensión en forma de Té	1121,88

Alineador con ajuste de ángulo (45° y 90°), y dos elementos fijadores para manguitos, reducciones y codos de DN 63, DN 90, DN 125 y DN180.

Se pueden acoplar medias lunas reductoras para crear diferentes configuraciones. Se suministra en una práctica bolsa.

El alineador se puede expandir con elementos fijadores adicionales para uso cuádruple de DN 63, DN 90, DN 125 y DN 160. Se necesitarían dos alineadores adicionales.

Disponible elemento de extensión en Té para fijación y alineación. Variante con un solo alineador. Elementos fijadores adicionales pueden acoplarse para fijación doble en acometidas.

Medias lunas de reducción para DN 110 y DN 160. Se necesita un juego de media luna para cada elemento fijador.



SQM 63 Y 125 - PINZADOR PARA TUBOS DESDE DN 20 HASTA DN 125

Ref.	Descripción	DN	SDR	€/Ud.
613025	Pinzador SQM 63	DN 20 a DN 63	SDR 11	270,31
613026	Pinzador SQM125	DN 63 a DN 90	SDR 11	641,31
613026	Pinzador SQM125	DN 90 a DN 125	SDR 17,6	641,31

Pinzador para corte temporal en tubos de PE-AD y PE-Xa en DN 63 a DN 125 en SDR 11 y SDR 17,6.

Cumple con la DVGW GW 332.



VACUPUMP - BOMBA DE VACÍO PARA UTILIZACIÓN EN OBRA PARA SA-XL Y RS-XL

Ref.	Descripción	€/Ud.
613827	Bomba de vacío 230 V	3.798,77

Para la instalación de derivaciones Frialen XL SA-XL y abrazaderas de reparación RS-XL.
 Se compone de bomba de vacío (110 V/230 V) manómetro y mangueras de conexión.
 No requiere compresor adicional para su funcionamiento.
 Se suministra en un maletín de aluminio.



SQH 180 - PINZADOR HIDRÁULICO PARA TUBOS DESDE DN 63 HASTA DN 180

Ref.	Descripción	DN	SDR	€/Ud.
613028	Pinzador SQH180	DN 63 a DN 180	SDR 11 Y SDR 17,6	1.676,17

Pinzador para corte temporal en tubos de PE-AD y PE-Xa en DN 63 a DN 125 en SDR 11 y SDR 17,6.
 Cumple con la DVGW GW 332.



PRODUCTOS LIMPIADORES DE ÓXIDO ESPECÍFICOS PARA POLIETILENO

Ref.	Descripción	€/Ud.
614001	Bote limpiador 0,75 Litros	31,65
614002	Toallitas limpiadoras	40,60

Producto específico para una óptima limpieza y desoxidación del PE.
 Alta volatilidad, 99,9% alcohol.

Accesorios de PE

Accesorios de Polietileno inyectados largos

INFRAESTRUCTURA



**RDPE - REDUCCIÓN**

Con cuello largo para soldar con accesorios de alta seguridad FRIALEN, o soldadura a tope.

PE 100 SDR11 - Máxima presión de trabajo permitida 16 bar (agua) / 10 bar (gas)



Aplicación



Ref.	Ø	€/Ud.
RDPE11003225	32-25	4,22
RDPE11004020	40-20	6,21
RDPE11004025	40-25	6,21
RDPE11004032	40-32	6,21
RDPE11005025	50-25	6,61
RDPE11005032	50-32	7,25
RDPE11005040	50-40	7,25
RDPE11006332	63-32	9,99
RDPE11006340	63-40	9,99
RDPE11006350	63-50	9,99
RDPE11007540	75-40	15,31
RDPE11007550	75-50	27,35
RDPE11007563	75-63	27,35
RDPE11009050	90-50	19,74
RDPE11009063	90-63	19,74
RDPE11009075	90-75	19,74
RDPE11011063	110-63	23,74
RDPE11011075	110-75	23,74
RDPE11011090	110-90	21,35
RDPE11012563	125-63	33,69
RDPE11012575	125-75	33,69
RDPE11012590	125-90	33,69
RDPE11125110	125-110	33,69
RDPE11014075	140-75	46,09
RDPE11014090	140-90	46,09
RDPE11140110	140-110	46,09
RDPE11140125	140-125	46,09
RDPE11016090	160-90	64,83
RDPE11160110	160-110	64,83
RDPE11160125	160-125	64,83
RDPE11160140	160-140	64,83

Ref.	Ø	€/Ud.
RDPE11180125	180-125	72,51
RDPE11180160	180-160	78,84
RDPE11200125	200-125	79,68
RDPE11200160	200-160	76,62
RDPE11225110	225-110	147,24
RDPE11225160	225-160	147,24
RDPE11225180	225-180	147,24
RDPE11250160	250-160	200,10
RDPE11250180	250-180	209,36
RDPE11250200	250-200	209,36
RDPE11250225	250-225	209,36
RDPE11280180	280-180	260,24
RDPE11280200	280-200	260,24
RDPE11280225	280-225	260,24
RDPE11280250	280-250	250,58
RDPE11315225	315-225	358,90
RDPE11315250	315-250	358,90
RDPE11315280	315-280	358,90
RDPE11355250	355-250	754,77
RDPE11355280	355-280	754,77
RDPE11355315	355-315	754,77
RDPE11400280	400-280	799,73
RDPE11400315	400-315	799,73
RDPE11400355	400-355	799,73
RDPE11450400	450-400	860,87
RDPE11500355	500-355	1.030,66
RDPE11500400	500-400	1.073,71
RDPE11500450	500-450	1.159,81
RDPE11630400	630-400	1.633,93
RDPE11630450	630-450	1.670,55
RDPE11630500	630-500	1.813,72

Para otras medidas, diámetros y tipo de accesorios, consultar.



PE 100 SDR17 - Máxima presión de trabajo permitida 10 bar (agua) / 5 bar (gas)

Aplicación



Ref.	Ø	€/Ud.
RDPE17007540	75-40	15,31
RDPE17007563	75-63	19,50
RDPE17009050	90-50	21,09
RDPE17009063	90-63	21,09
RDPE17009075	90-75	21,09
RDPE17011063	110-63	18,49
RDPE17011075	110-75	18,49
RDPE17011090	110-90	15,72
RDPE17012563	125-63	33,69
RDPE17012575	125-75	33,69
RDPE17012590	125-90	33,69
RDPE17125110	125-110	33,69
RDPE17014075	140-75	48,39
RDPE17014090	140-90	48,39
RDPE17140110	140-110	48,39
RDPE17140125	140-125	48,39
RDPE17016090	160-90	64,83
RDPE17160110	160-110	64,83
RDPE17160125	160-125	64,83
RDPE17160140	160-140	64,83
RDPE17180125	180-125	72,51
RDPE17180160	180-160	78,84
RDPE17200125	200-125	67,88
RDPE17200160	200-160	61,97
RDPE17225110	225-110	147,24
RDPE17225160	225-160	147,24
RDPE17225180	225-180	147,24

Ref.	Ø	€/Ud.
RDPE17250160	250-160	209,36
RDPE17250180	250-180	209,36
RDPE17250200	250-200	209,36
RDPE17250225	250-225	209,36
RDPE17280180	280-180	260,24
RDPE17280200	280-200	260,24
RDPE17280225	280-225	260,24
RDPE17280250	280-250	250,58
RDPE17315225	315-225	358,90
RDPE17315250	315-250	358,90
RDPE17315280	315-280	358,90
RDPE17355250	355-250	799,73
RDPE17355280	355-280	799,73
RDPE17355315	355-315	470,69
RDPE17400280	400-280	845,01
RDPE17400315	400-315	845,01
RDPE17400355	400-355	731,80
RDPE17450315	450-315	890,45
RDPE17450355	450-355	926,61
RDPE17450400	450-400	977,74
RDPE17500355	500-355	1.151,71
RDPE17500400	500-400	1.216,34
RDPE17500450	500-450	1.280,92
RDPE17630400	630-400	1.573,47
RDPE17630450	630-450	1.643,96
RDPE17630500	630-500	1.801,42



WWPE - CODO 30°

Con cuello largo para soldar con accesorios de alta seguridad FRIALEN, o soldadura a tope.

Aplicación



PE 100 SDR11 - Máxima presión de trabajo permitida 16 bar (agua) / 10 bar (gas)

Ref.	Ø	€/Ud.
WWPE1100075	75	31,70
WWPE1100090	90	46,16
WWPE1100110	110	68,43
WWPE1100125	125	112,33
WWPE1100140	140	123,03
WWPE1100160	160	157,25
WWPE1100180	180	225,31
WWPE1100200	200	282,92
WWPE1100225	225	351,86

PE 100 SDR17 - Máxima presión de trabajo permitida 10 bar (agua) / 5 bar (gas)

Ref.	Ø	€/Ud.
WWPE1700075	75	30,83
WWPE1700090	90	38,78
WWPE1700110	110	50,53
WWPE1700125	125	79,04
WWPE1700140	140	102,31
WWPE1700160	160	115,31
WWPE1700180	180	162,92
WWPE1700200	200	179,80
WWPE1700225	225	229,92

Para otras medidas, diámetros y tipo de accesorios, consultar.



Aplicación



HDPE - CODO 45°

Con cuello largo para soldar con accesorios de alta seguridad FRIALEN, o soldadura a tope.

PE 100 SDR11 - Máxima presión de trabajo permitida 16 bar (agua) / 10 bar (gas)

Ref.	Ø	€/Ud.
HDPE11000025	25	6,21
HDPE11000032	32	7,43
HDPE11000040	40	9,31
HDPE11000050	50	10,57
HDPE11000063	63	18,87
HDPE11000075	75	25,48
HDPE11000090	90	20,58
HDPE11000110	110	29,33
HDPE11000125	125	67,12
HDPE11000140	140	74,97
HDPE11000160	160	71,95
HDPE11000180	180	111,49
HDPE11000200	200	130,12
HDPE11000225	225	181,03
HDPE11000250	250	313,86
HDPE11000280	280	473,55
HDPE11000315	315	574,85
HDPE11000355	355	1.312,49
HDPE11000400	400	1.749,75
HDPE11000450	450	2.386,59
HDPE11000500	500	2.677,60

PE 100 SDR17 - Máxima presión de trabajo permitida 10 bar (agua) / 5 bar (gas)

Ref.	Ø	€/Ud.
HDPE17000063	63	7,80
HDPE17000075	75	23,02
HDPE17000090	90	19,57
HDPE17000110	110	27,77
HDPE17000125	125	60,55
HDPE17000140	140	74,25
HDPE17000160	160	55,23
HDPE17000180	180	99,50
HDPE17000200	200	104,76
HDPE17000225	225	162,82
HDPE17000250	250	270,00
HDPE17000280	280	407,47
HDPE17000315	315	507,04
HDPE17000355	355	945,50
HDPE17000400	400	1.419,42
HDPE17000450	450	1.671,34
HDPE17000500	500	2.117,59



Aplicación



GDPE - CODO 90°

Con cuello largo para soldar con accesorios de alta seguridad FRIALEN, o soldadura a tope.

PE 100 SDR11 - Máxima presión de trabajo permitida 16 bar (agua) / 10 bar (gas)

Ref.	Ø	€/Ud.
GDPE11000025	25	5,68
GDPE11000032	32	6,18
GDPE11000040	40	7,84
GDPE11000050	50	10,39
GDPE11000063	63	18,87
GDPE11000075	75	24,88
GDPE11000090	90	18,37
GDPE11000110	110	28,82
GDPE11000125	125	67,12
GDPE11000140	140	74,97
GDPE11000160	160	79,09
GDPE11000180	180	110,54
GDPE11000200	200	140,69
GDPE11000225	225	192,60
GDPE11000250	250	299,89
GDPE11000280	280	505,11
GDPE11000315	315	636,14
GDPE11000355	355	1.285,23
GDPE11000400	400	1.770,22
GDPE11000450	450	2.316,00
GDPE11000500	500	2.825,57

PE 100 SDR17 - Máxima presión de trabajo permitida 10 bar (agua) / 5 bar (gas)

Ref.	Ø	€/Ud.
GDPE17000063	63	8,26
GDPE17000075	75	22,55
GDPE17000090	90	18,46
GDPE17000110	110	31,07
GDPE17000125	125	60,55
GDPE17000140	140	74,25
GDPE17000160	160	66,55
GDPE17000180	180	99,50
GDPE17000200	200	127,73
GDPE17000225	225	162,82
GDPE17000250	250	268,41
GDPE17000280	280	405,07
GDPE17000315	315	507,16
GDPE17000355	355	1.049,41
GDPE17000400	400	1.278,94
GDPE17000450	450	1.627,05
GDPE17000500	500	2.268,62

Para otras medidas, diámetros y tipo de accesorios, consultar.



Aplicación



YEPE - Y 45°

Con cuello largo para soldar con accesorios de alta seguridad FRIALEN, o soldadura a tope.

PE 100 SDR11 - Máxima presión de trabajo permitida 16 bar (agua) / 10 bar (gas)

Ref.	Ø	€/Ud.
YEPE11000040	40	12,71
YEPE11000050	50	22,01
YEPE11000063	63	41,01
YEPE11000075	75	54,85
YEPE11000090	90	97,99
YEPE11000110	110	131,71
YEPE11000125	125	259,26
YEPE11000160	160	418,91
YEPE11000180	180	555,77
YEPE11000200	200	687,10
YEPE11000225	225	943,87
YEPE17000315	315	910,95

PE 100 SDR17 - Máxima presión de trabajo permitida 10 bar (agua) / 5 bar (gas)

Ref.	Ø	€/Ud.
YEPE17000040	40	6,65
YEPE17000050	50	20,93
YEPE17000063	63	35,24
YEPE17000075	75	50,45
YEPE17000090	90	105,91
YEPE17000110	110	94,76
YEPE17000125	125	237,12
YEPE17000160	160	396,37
YEPE17000180	180	521,30
YEPE17000200	200	616,90
YEPE17000225	225	889,14
YEPE17000315	315	910,95



Aplicación



TEPE - TE IGUAL 90°

Con cuello largo para soldar con accesorios de alta seguridad FRIALEN, o soldadura a tope.

PE 100 SDR11 - Máxima presión de trabajo permitida 16 bar (agua) / 10 bar (gas)

Ref.	Ø	€/Ud.
TEPE11000025	25	6,89
TEPE11000032	32	8,22
TEPE11000040	40	9,90
TEPE11000050	50	13,12
TEPE11000063	63	18,00
TEPE11000075	75	27,23
TEPE11000090	90	25,54
TEPE11000110	110	39,63
TEPE11000125	125	84,00
TEPE11000140	140	126,99
TEPE11000160	160	100,76
TEPE11000180	180	208,38
TEPE11000200	200	191,66
TEPE11000225	225	355,38
TEPE11000250	250	504,51
TEPE11000280	280	648,78
TEPE11000315	315	969,12
TEPE11000355	355	1.574,42
TEPE11000400	400	1.656,66
TEPE11000450	450	2.154,31
TEPE11000500	500	2.943,03

PE 100 SDR17 - Máxima presión de trabajo permitida 10 bar (agua) / 5 bar (gas)

Ref.	Ø	€/Ud.
TEPE17000063	63	13,84
TEPE17000075	75	23,56
TEPE17000090	90	28,56
TEPE17000110	110	37,91
TEPE17000125	125	71,36
TEPE17000140	140	108,53
TEPE17000160	160	91,46
TEPE17000180	180	177,30
TEPE17000200	200	163,61
TEPE17000225	225	301,70
TEPE17000250	250	302,96
TEPE17000280	280	414,67
TEPE17000315	315	576,83
TEPE17000355	355	1.471,37
TEPE17000400	400	1.314,58
TEPE17000450	450	1.536,84
TEPE17000500	500	3.135,97

Para otras medidas, diámetros y tipo de accesorios, consultar.



Aplicación



TRPE - TE REDUCIDA 90°

Con cuello largo para soldar con accesorios de alta seguridad FRIALEN, o soldadura a tope.

PE 100 SDR11 - Máxima presión de trabajo permitida 16 bar (agua) / 10 bar (gas)

Ref.	Ø	€/Ud.
TRPE11006332	63-32	36,81
TRPE11011063	110-63	64,32
TRPE11011090	110-90	41,87
TRPE11012563	125-63	97,08
TRPE11012575	125-75	97,08
TRPE11012590	125-90	97,08
TRPE11125110	125-110	97,08
TRPE11014063	140-63	146,63
TRPE11014075	140-75	146,63
TRPE11014090	140-90	146,63
TRPE11140110	140-110	151,91
TRPE11016063	160-63	175,77
TRPE11016075	160-75	177,12
TRPE11016090	160-90	177,12
TRPE11160110	160-110	181,70
TRPE11018075	180-75	251,77
TRPE11018090	180-90	251,77
TRPE11180110	180-110	251,77
TRPE11180125	180-125	251,77

Ref.	Ø	€/Ud.
TRPE11180140	180-140	244,46
TRPE11180160	180-160	244,46
TRPE11020063	200-63	319,40
TRPE11020075	200-75	319,40
TRPE11020090	200-90	319,40
TRPE11200110	200-110	226,14
TRPE11200125	200-125	319,40
TRPE11200160	200-160	319,40
TRPE11022563	225-63	394,69
TRPE11022575	225-75	394,69
TRPE11022590	225-90	410,15
TRPE11225110	225-110	413,19
TRPE11225125	225-125	414,33
TRPE11225140	225-140	414,55
TRPE11225160	225-160	414,55
TRPE11250160	250-160	544,89
TRPE11280160	280-160	465,84
TRPE11315160	315-160	633,77

PE 100 SDR17 - Máxima presión de trabajo permitida 10 bar (agua) / 5 bar (gas)

Ref.	Ø	€/Ud.
TRPE17011063	110-63	57,70
TRPE17011090	110-90	44,32
TRPE17012563	125-63	76,08
TRPE17012575	125-75	76,08
TRPE17012590	125-90	76,08
TRPE17125110	125-110	76,08
TRPE17014063	140-63	125,59
TRPE17014075	140-75	125,59
TRPE17014090	140-90	125,59
TRPE17140110	140-110	130,52
TRPE17016063	160-63	158,16
TRPE17016075	160-75	163,04
TRPE17016090	160-90	163,04
TRPE17160110	160-110	164,47
TRPE17018075	180-75	251,77
TRPE17018090	180-90	251,77
TRPE17180110	180-110	251,77

Ref.	Ø	€/Ud.
TRPE17180125	180-125	251,77
TRPE17180140	180-140	219,82
TRPE17180160	180-160	219,82
TRPE17020063	200-63	281,72
TRPE17020075	200-75	281,72
TRPE17020090	200-90	281,72
TRPE17200110	200-110	180,61
TRPE17200125	200-125	281,72
TRPE17200160	200-160	281,72
TRPE17022563	225-63	369,59
TRPE17022575	225-75	369,59
TRPE17022590	225-90	369,59
TRPE17225110	225-110	372,24
TRPE17225125	225-125	372,24
TRPE17225140	225-140	372,24
TRPE17225160	225-160	372,24

Para otras medidas, diámetros y tipo de accesorios, consultar.



Aplicación

**CDPE - TAPÓN**

Con cuello largo para soldar con accesorios de alta seguridad FRIALEN, o soldadura a tope.

PE 100 SDR11 - Máxima presión de trabajo permitida 16 bar (agua) / 10 bar (gas)

Ref.	Ø	€/Ud.
CDPE11000025	25	5,12
CDPE11000032	32	5,94
CDPE11000040	40	7,92
CDPE11000050	50	10,14
CDPE11000063	63	13,43
CDPE11000075	75	24,83
CDPE11000090	90	13,97
CDPE11000110	110	21,81
CDPE11000125	125	44,14
CDPE11000140	140	55,64
CDPE11000160	160	43,54
CDPE11000180	180	80,05
CDPE11000200	200	79,71
CDPE11000225	225	119,06
CDPE11000250	250	137,21
CDPE11000280	280	193,30
CDPE11000315	315	264,66
CDPE11000355	355	522,72
CDPE11000400	400	660,26
CDPE11000450	450	517,08
CDPE11000500	500	681,51
CDPE11000630	630	1.488,88

PE 100 SDR17 - Máxima presión de trabajo permitida 10 bar (agua) / 5 bar (gas)

Ref.	Ø	€/Ud.
CDPE17000063	63	3,19
CDPE17000075	75	25,05
CDPE17000090	90	12,91
CDPE17000110	110	17,02
CDPE17000125	125	44,08
CDPE17000140	140	55,23
CDPE17000160	160	36,10
CDPE17000180	180	80,05
CDPE17000200	200	72,63
CDPE17000225	225	119,06
CDPE17000250	250	70,70
CDPE17000280	280	193,30
CDPE17000315	315	264,66
CDPE17000355	355	415,06
CDPE17000400	400	508,82
CDPE17000450	450	344,59
CDPE17000500	500	450,27
CDPE17000630	630	914,80



Aplicación



CUPE - CURVA 11°

Con cuello largo para soldar con accesorios de alta seguridad FRIALEN, o soldadura a tope.

PE 100 SDR11 - Máxima presión de trabajo permitida 16 bar (agua) / 10 bar (gas)

Ref.	Ø	€/Ud.
CU11PE110090	90	107,57
CU11PE110110	110	143,22
CU11PE110125	125	159,07
CU11PE110140	140	179,47
CU11PE110160	160	204,94
CU11PE110180	180	342,48
CU11PE110200	200	414,93
CU11PE110225	225	495,32
CU11PE110250	250	593,84
CU11PE110280	280	726,28
CU11PE110315	315	881,40
CU11PE110355	355	1.627,51
CU11PE110400	400	1.953,01
CU11PE110450	450	2.399,64



Aplicación



CUPE - CURVA 22°

Con cuello largo para soldar con accesorios de alta seguridad FRIALEN, o soldadura a tope.

PE 100 SDR11 - Máxima presión de trabajo permitida 16 bar (agua) / 10 bar (gas)

Ref.	Ø	€/Ud.
CU22PE110090	90	107,57
CU22PE110110	110	143,22
CU22PE110125	125	159,07
CU22PE110140	140	179,47
CU22PE110160	160	204,94
CU22PE110180	180	342,48
CU22PE110200	200	414,93
CU22PE110225	225	495,32
CU22PE110250	250	593,84
CU22PE110280	280	726,28
CU22PE110315	315	881,40
CU22PE110355	355	1.627,51
CU22PE110400	400	1.953,01
CU22PE110450	450	2.399,64

PE 100 SDR17 - Máxima presión de trabajo permitida 10 bar (agua) / 5 bar (gas)

Ref.	Ø	€/Ud.
CU11PE170090	90	88,31
CU11PE170110	110	113,22
CU11PE170125	125	128,51
CU11PE170140	140	146,61
CU11PE170160	160	157,37
CU11PE170180	180	251,33
CU11PE170200	200	303,99
CU11PE170225	225	360,59
CU11PE170250	250	447,21
CU11PE170280	280	510,04
CU11PE170315	315	657,80
CU11PE170355	355	1.048,95
CU11PE170400	400	1.588,45
CU11PE170450	450	1.909,42

PE 100 SDR17 - Máxima presión de trabajo permitida 10 bar (agua) / 5 bar (gas)

Ref.	Ø	€/Ud.
CU22PE170090	90	88,31
CU22PE170110	110	113,22
CU22PE170125	125	128,51
CU22PE170140	140	146,61
CU22PE170160	160	157,37
CU22PE170180	180	251,33
CU22PE170200	200	303,99
CU22PE170225	225	360,59
CU22PE170250	250	447,21
CU22PE170280	280	510,04
CU22PE170315	315	657,80
CU22PE170355	355	1.048,95
CU22PE170400	400	1.588,45
CU22PE170450	450	1.909,42

Para otras medidas, diámetros y tipo de accesorios, consultar.



Aplicación



CUPE - CURVA 30°

Con cuello largo para soldar con accesorios de alta seguridad FRIALEN, o soldadura a tope.

PE 100 SDR11 - Máxima presión de trabajo permitida 16 bar (agua) / 10 bar (gas)

Ref.	Ø	€/Ud.
CU30PE110090	90	107,57
CU30PE110110	110	143,22
CU30PE110125	125	159,07
CU30PE110140	140	179,47
CU30PE110160	160	204,94
CU30PE110180	180	342,48
CU30PE110200	200	414,93
CU30PE110225	225	495,32
CU30PE110250	250	593,84
CU30PE110280	280	726,28
CU30PE110315	315	881,40
CU30PE110355	355	1.627,51
CU30PE110400	400	1.953,01
CU30PE110450	450	2.399,64

PE 100 SDR17 - Máxima presión de trabajo permitida 10 bar (agua) / 5 bar (gas)

Ref.	Ø	€/Ud.
CU30PE170090	90	88,31
CU30PE170110	110	113,22
CU30PE170125	125	128,51
CU30PE170140	140	146,61
CU30PE170160	160	157,37
CU30PE170180	180	251,33
CU30PE170200	200	303,99
CU30PE170225	225	360,59
CU30PE170250	250	447,21
CU30PE170280	280	510,04
CU30PE170315	315	657,80
CU30PE170355	355	1.048,95
CU30PE170400	400	1.588,45
CU30PE170450	450	1.909,42



Aplicación



CUPE - CURVA 45°

Con cuello largo para soldar con accesorios de alta seguridad FRIALEN, o soldadura a tope.

PE 100 SDR11 - Máxima presión de trabajo permitida 16 bar (agua) / 10 bar (gas)

Ref.	Ø	€/Ud.
CU45PE110090	90	107,57
CU45PE110110	110	143,22
CU45PE110125	125	159,07
CU45PE110140	140	179,47
CU45PE110160	160	204,94
CU45PE110180	180	342,48
CU45PE110200	200	414,93
CU45PE110225	225	495,32
CU45PE110250	250	593,84
CU45PE110280	280	726,28
CU45PE110315	315	881,40
CU45PE110355	355	1.627,51
CU45PE110400	400	1.953,01
CU45PE110450	450	2.399,64

PE 100 SDR17 - Máxima presión de trabajo permitida 10 bar (agua) / 5 bar (gas)

Ref.	Ø	€/Ud.
CU45PE170090	90	88,31
CU45PE170110	110	113,22
CU45PE170125	125	128,51
CU45PE170140	140	146,61
CU45PE170160	160	157,37
CU45PE170180	180	251,33
CU45PE170200	200	303,99
CU45PE170225	225	360,59
CU45PE170250	250	447,21
CU45PE170280	280	510,04
CU45PE170315	315	657,80
CU45PE170355	355	1.048,95
CU45PE170400	400	1.588,45
CU45PE170450	450	1.909,42



Aplicación



CUPE - CURVA 60°

Con cuello largo para soldar con accesorios de alta seguridad FRIALEN, o soldadura a tope.

PE 100 SDR11 - Máxima presión de trabajo permitida 16 bar (agua) / 10 bar (gas)

Ref.	Ø	€/Ud.
CU60PE110090	90	107,57
CU60PE110110	110	143,22
CU60PE110125	125	159,07
CU60PE110140	140	179,47
CU60PE110160	160	204,94
CU60PE110180	180	342,48
CU60PE110200	200	414,93
CU60PE110225	225	495,32
CU60PE110250	250	593,84
CU60PE110280	280	726,28
CU60PE110315	315	881,40
CU60PE110355	355	1.627,51
CU60PE110400	400	1.953,01
CU60PE110450	450	2.399,64

PE 100 SDR17 - Máxima presión de trabajo permitida 10 bar (agua) / 5 bar (gas)

Ref.	Ø	€/Ud.
CU60PE170090	90	88,31
CU60PE170110	110	113,22
CU60PE170125	125	128,51
CU60PE170140	140	146,61
CU60PE170160	160	157,37
CU60PE170180	180	251,33
CU60PE170200	200	303,99
CU60PE170225	225	360,59
CU60PE170250	250	447,21
CU60PE170280	280	510,04
CU60PE170315	315	657,80
CU60PE170355	355	1.048,95
CU60PE170400	400	1.588,45
CU60PE170450	450	1.909,42



Aplicación



CUPE - CURVA 90°

Con cuello largo para soldar con accesorios de alta seguridad FRIALEN, o soldadura a tope.

PE 100 SDR11 - Máxima presión de trabajo permitida 16 bar (agua) / 10 bar (gas)

Ref.	Ø	€/Ud.
CU90PE110090	90	111,50
CU90PE110110	110	148,88
CU90PE110125	125	170,95
CU90PE110140	140	196,44
CU90PE110160	160	228,69
CU90PE110180	180	377,57
CU90PE110200	200	458,53
CU90PE110225	225	544,01
CU90PE110250	250	677,04
CU90PE110280	280	848,01
CU90PE110315	315	1.052,35
CU90PE110355	355	1.574,30
CU90PE110400	400	1.913,37
CU90PE110450	450	2.704,22

PE 100 SDR17 - Máxima presión de trabajo permitida 10 bar (agua) / 5 bar (gas)

Ref.	Ø	€/Ud.
CU90PE170090	90	91,14
CU90PE170110	110	117,18
CU90PE170125	125	135,87
CU90PE170140	140	156,80
CU90PE170160	160	172,09
CU90PE170180	180	275,12
CU90PE170200	200	331,15
CU90PE170225	225	390,03
CU90PE170250	250	506,08
CU90PE170280	280	587,60
CU90PE170315	315	767,05
CU90PE170355	355	1.046,13
CU90PE170400	400	1.559,57
CU90PE170450	450	2.207,18

Accesorios de PE

Accesorios de Polietileno inyectados cortos

INFRAESTRUCTURA





Aplicación



Aplicación



TBE - TÉS IGUALES A 90° CORTAS

Con cuello corto para soldadura a tope

PE 100 SDR11 - Máxima presión de trabajo permitida 16 bar (agua) / 10 bar (gas)

Ref.	Ø	€/Ud.
TBE11020	20	2,38
TBE11025	25	2,38
TBE11032	32	2,98
TBE11040	40	4,80
TBE11050	50	6,44
TBE11063	63	9,95
TBE11075	75	20,11
TBE11090	90	29,97
TBE11110	110	44,04
TBE11125	125	60,66
TBE11140	140	76,88
TBE11160	160	129,29
TBE11180	180	165,73
TBE11200	200	237,51
TBE11225	225	282,47
TBE11250	250	359,34
TBE11280	280	485,81
TBE11315	315	690,11
TBE11355	355	1.264,82
TBE11400	400	1.888,56
TBE11450	450	2.495,12
TBE11500	500	3.188,92

PE 100 SDR17 - Máxima presión de trabajo permitida 10 bar (agua) / 5 bar (gas)

Ref.	Ø	€/Ud.
TBE17050	50	5,70
TBE17063	63	7,78
TBE17075	75	15,88
TBE17090	90	22,57
TBE17110	110	37,46
TBE17125	125	51,87
TBE17140	140	61,30
TBE17160	160	115,18
TBE17180	180	141,59
TBE17200	200	193,29
TBE17225	225	226,96
TBE17250	250	301,15
TBE17280	280	340,45
TBE17315	315	452,81
TBE17355	355	1.067,67
TBE17400	400	1.459,20
TBE17450	450	2.029,31
TBE17500	500	2.611,54

TRBE - TÉS REDUCIDAS A 90° CORTAS

Con cuello corto para soldadura a tope

PE 100 SDR11 - Máxima presión de trabajo permitida 16 bar (agua) / 10 bar (gas)

Ref.	Ø	€/Ud.
TRBE11090050	90-50	44,75
TRBE11110032	110-32	64,34
TRBE111100500	110-50	65,40
TRBE11125063	125-63	91,92
TRBE11140063	140-63	115,35
TRBE11140075	140-75	115,35
TRBE11140090	140-90	117,17
TRBE11140110	140-110	117,17
TRBE11160110	160-110	206,21
TRBE11160125	160-125	206,21
TRBE11180063	180-63	241,41
TRBE11180075	180-75	241,41
TRBE11180125	180-125	249,16
TRBE11225110	225-110	437,76
TRBE11225125	225-125	437,76
TRBE11225160	225-160	455,07
TRBE11250160	250-160	566,16

PE 100 SDR17 - Máxima presión de trabajo permitida 10 bar (agua) / 5 bar (gas)

Ref.	Ø	€/Ud.
TRBE17110090	110-90	67,02
TRBE17140063	140-63	89,52
TRBE17140075	140-75	89,95
TRBE17140090	1409-90	91,41
TRBE17140110	140-110	93,26
TRBE17160110	160-110	182,54
TRBE17160125	160-125	182,54
TRBE17180063	180-63	206,46
TRBE17180075	180-75	206,46
TRBE17180125	180-125	212,77
TRBE17225110	225-110	365,14
TRBE17225125	225-125	365,14
TRBE17225160	225-160	365,14



Aplicación



RBE - REDUCCIONES CONCÉNTRICAS CORTAS

Con cuello corto para soldadura a tope

PE 100 SDR11 - Máxima presión de trabajo permitida 16 bar (agua) / 10 bar (gas)

Ref.	Ø	€/Ud.
RBE11025020	25-20	4,68
RBE11032020	32-20	5,46
RBE11032025	32-25	5,46
RBE11040020	40-20	6,25
RBE11040025	40-25	6,25
RBE11040032	40-32	6,25
RBE11050025	50-25	6,52
RBE11050032	50-32	6,52
RBE11050040	50-40	6,52
RBE11063032	63-32	7,90
RBE11063040	63-40	7,90
RBE11063050	63-50	7,90
RBE11075032	75-32	10,17
RBE11075040	75-40	10,17
RBE11075063	75-63	10,17
RBE11090050	90-50	11,24
RBE11090063	90-63	11,24
RBE11090075	90-75	11,24
RBE11110050	110-50	14,37
RBE11110063	110-63	14,37
RBE11110075	110-75	14,37
RBE11110090	110-90	14,37
RBE11125063	125-63	18,46
RBE11125075	125-75	18,46
RBE11125090	125-90	18,46
RBE11125110	125-110	18,46
RBE11140075	140-75	22,34
RBE11140090	140-90	22,34
RBE11140110	140-110	22,34
RBE11140125	140-125	22,34
RBE11160090	160-90	26,14
RBE11160110	160-110	26,14
RBE11160125	160-125	26,14
RBE11160140	160-140	26,14
RBE11180090	180-90	41,07
RBE11180110	180-110	38,69
RBE11180125	180-125	35,63
RBE11180140	180-140	33,84
RBE11180160	180-160	32,31
RBE11200140	200-140	92,51
RBE11200160	200-160	52,96
RBE11200180	200-180	44,44
RBE11225140	225-140	110,54

Ref.	Ø	€/Ud.
RBE11225160	225-160	68,31
RBE11225180	225-180	79,52
RBE11225200	225-200	75,20
RBE11250160	250-160	111,00
RBE11250180	250-180	107,78
RBE11250200	250-200	102,12
RBE11250225	250-225	102,39
RBE11280200	280-200	141,03
RBE11280225	280-225	127,68
RBE11280250	280-250	122,93
RBE11315200	315-200	174,78
RBE11315225	315-225	154,58
RBE11315250	315-250	140,82
RBE11315280	315-280	131,93
RBE11355200	355-200	306,72
RBE11355225	355-225	294,93
RBE11355250	355-250	187,38
RBE11355280	355-280	167,84
RBE11355315	355-315	160,04
RBE11400225	400-225	292,71
RBE11400250	400-250	261,52
RBE11400280	400-280	888,07
RBE11400315	400-315	269,33
RBE11400355	400-355	187,38
RBE11450280	450-280	1.269,80
RBE11450315	450-315	1.126,91
RBE11450355	450-355	812,52
RBE11450400	450-400	273,22
RBE11500280	500-280	2.222,09
RBE11500315	500-315	468,44
RBE11500355	500-355	1.482,73
RBE11500400	500-400	390,35
RBE11500450	500-450	351,24
RBE11560355	560-355	2.568,94
RBE11560400	560-400	1.938,54
RBE11560450	560-450	1.180,88
RBE11560500	560-500	484,00
RBE11630355	630-355	3.575,37
RBE11630400	630-400	870,44
RBE11630450	630-450	2.620,44
RBE11630500	630-500	694,79
RBE11630560	630-560	577,68



Aplicación



RBE - REDUCCIONES CONCÉNTRICAS CORTAS

Con cuello corto para soldadura a tope

PE 100 SDR17 - Máxima presión de trabajo permitida 10 bar (agua) / 5 bar (gas)

Ref.	Ø	€/Ud.
RBE17050032	50-32	6,25
RBE17050040	50-40	6,25
RBE17063032	63-32	7,49
RBE17063040	63-40	7,49
RBE17063050	63-50	7,49
RBE17075032	75-32	9,63
RBE17075040	75-40	9,63
RBE17075050	75-50	9,63
RBE17075063	75-63	9,63
RBE17090050	90-50	10,75
RBE17090063	90-63	10,75
RBE17090075	90-75	10,75
RBE17110050	110-50	13,69
RBE17110063	110-63	13,69
RBE17110075	110-75	13,69
RBE17110090	110-90	13,69
RBE17125063	125-63	17,59
RBE17125075	125-75	17,59
RBE17125090	125-90	17,59
RBE17125110	125-110	17,59
RBE17140075	140-75	21,31
RBE17140090	140-90	21,31
RBE17140110	140-110	21,31
RBE17140125	140-125	21,31
RBE17160090	160-90	24,90
RBE17160110	160-110	24,90
RBE17160125	160-125	24,90
RBE17160140	160-140	24,90
RBE17180090	180-90	39,06
RBE17180110	180-110	36,82
RBE17180125	180-125	33,95
RBE17180140	180-140	32,25
RBE17180160	180-160	23,98
RBE17200140	200-140	88,11
RBE17200160	200-160	40,98
RBE17200180	200-180	37,54
RBE17225140	225-140	105,18
RBE17225160	225-160	69,67
RBE17225180	225-180	75,73
RBE17225200	225-200	53,30
RBE17250160	250-160	87,09
RBE17250180	250-180	102,68
RBE17250200	250-200	80,24
RBE17250225	250-225	74,49
RBE17280200	280-200	109,30
RBE17280225	280-225	125,21

Ref.	Ø	€/Ud.
RBE17280250	280-250	97,69
RBE17315200	315-200	166,39
RBE17315225	315-225	151,56
RBE17315250	315-250	138,22
RBE17315280	315-280	129,39
RBE17355200	355-200	300,92
RBE17355225	355-225	289,33
RBE17355250	355-250	134,65
RBE17355280	355-280	128,80
RBE17355315	355-315	111,61
RBE17400225	400-225	1.067,32
RBE17400250	400-250	195,18
RBE17400280	400-280	888,07
RBE17400315	400-315	232,30
RBE17400355	400-355	140,46
RBE17450280	450-280	1.269,80
RBE17450315	450-315	633,08
RBE17450355	450-355	1.126,91
RBE17450400	450-400	191,20
RBE17500280	500-280	2.222,09
RBE17500315	500-315	325,14
RBE17500355	500-355	1.354,37
RBE17500400	500-400	261,52
RBE17500450	500-450	253,72
RBE17560355	560-355	2.893,30
RBE17560400	560-400	1.814,43
RBE17560450	560-450	1.131,42
RBE17560500	560-500	320,09
RBE17630355	630-355	3.126,04
RBE17630400	630-400	683,10
RBE17630450	630-450	2.435,19
RBE17630500	630-500	502,02
RBE17630560	630-560	429,36
RBE17710500	710-500	887,09
RBE17710560	710-560	2.219,99
RBE17710630	70-630	637,59
RBE17800560	800-560	930,94
RBE17800630	800-630	1.089,04
RBE17800710	800-710	901,97
RBE17900630	900-630	1.861,92
RBE17900710	900-710	4.722,79
RBE17900800	900-800	1.203,21
RBE171000710	1000-710	7.308,86
RBE171000800	1000-800	6.147,38
RBE171000900	1000-900	5.019,49



Aplicación



REBE - REDUCCIONES EXCÉNTRICAS CORTAS

Con cuello corto para soldadura a tope

PE 100 SDR11 - Máxima presión de trabajo permitida 16 bar (agua) / 10 bar (gas)

Ref.	Ø	€/Ud.
REBE11160090	160-90	293,73
REBE11160110	160-110	263,57
REBE11160125	160-125	235,59
REBE11160140	160-140	207,59
REBE11180110	180-110	348,28
REBE11180125	180-125	309,33
REBE11180140	180-140	286,83
REBE11180160	180-160	263,93
REBE11200125	200-125	375,46
REBE11200140	200-140	341,33
REBE11200160	200-160	303,20
REBE11200180	200-180	286,83
REBE11225140	225-140	471,83
REBE11225160	225-160	436,57
REBE11225180	225-180	379,88
REBE11225200	225-200	345,71
REBE11250160	250-160	559,08
REBE11250180	250-180	539,04
REBE11250200	250-200	488,24
REBE11250225	250-225	420,65
REBE11280180	280-180	628,93
REBE11280200	280-200	561,28
REBE11280225	280-225	511,11
REBE11280250	280-250	453,30
REBE11315200	315-200	696,15
REBE11315225	315-225	615,43
REBE11315250	315-250	533,65
REBE11315280	315-280	483,07

PE 100 SDR17 - Máxima presión de trabajo permitida 10 bar (agua) / 5 bar (gas)

Ref.	Ø	€/Ud.
REBE17160090	160-90	279,62
REBE17160110	160-110	242,81
REBE17160125	160-125	221,00
REBE17160140	160-140	196,67
REBE17180110	180-110	331,88
REBE17180125	180-125	294,48
REBE17180140	180-140	268,29
REBE17180160	180-160	246,51
REBE17200125	200-125	357,70
REBE17200140	200-140	323,21
REBE17200160	200-160	284,98
REBE17200180	200-180	268,65
REBE17225140	225-140	448,96
REBE17225160	225-160	420,25
REBE17225180	225-180	366,76
REBE17225200	225-200	329,35
REBE17250160	250-160	532,94
REBE17250180	250-180	512,56
REBE17250200	250-200	469,64
REBE17250225	250-225	391,15
REBE17280180	280-180	598,69
REBE17280200	280-200	550,79
REBE17280225	280-225	495,82
REBE17280250	280-250	424,93
REBE17315200	315-200	663,05
REBE17315225	315-225	587,12
REBE17315250	315-250	513,62
REBE17315280	315-280	466,42



Aplicación

**GBE - CURVAS CORTAS DE 90°**

Con cuello corto para soldadura a tope

PE 100 SDR11 - Máxima presión de trabajo permitida 16 bar (agua) / 10 bar (gas)

Ref.	Ø	€/Ud.
GBE11020	20	2,98
GBE11025	25	3,10
GBE11032	32	3,18
GBE11040	40	4,16
GBE11050	50	5,21
GBE11063	63	7,49
GBE11075	75	10,37
GBE11090	90	15,00
GBE11110	110	28,51
GBE11125	125	40,25
GBE11140	140	53,75
GBE11160	160	65,54
GBE11180	180	77,58
GBE11200	200	115,61
GBE11225	225	137,87
GBE11250	250	265,40
GBE11280	280	345,10
GBE11315	315	476,34
GBE11355	355	1.092,77
GBE11400	400	1.500,55
GBE11450	450	1.969,06
GBE11500	500	2.540,08

PE 100 SDR17 - Máxima presión de trabajo permitida 10 bar (agua) / 5 bar (gas)

Ref.	Ø	€/Ud.
GBE17050	50	4,99
GBE17063	63	6,91
GBE17075	75	10,17
GBE17090	90	13,19
GBE17110	110	27,79
GBE17125	125	35,37
GBE17140	140	51,32
GBE17160	160	56,62
GBE17180	180	70,03
GBE17200	200	86,71
GBE17225	225	106,85
GBE17250	250	180,46
GBE17280	280	234,53
GBE17315	315	324,00
GBE17355	355	805,10
GBE17400	400	1.121,15
GBE17450	450	1.465,61
GBE17500	500	1.849,46



Aplicación



BBEC - UNIONES 3 PIEZAS CORTAS

Con cuello corto para soldadura a tope

PE 100 SDR11 - Máxima presión de trabajo permitida 10 bar (agua)

Ref.	Ø	€/Ud.
BBEC11020E	20	19,03
BBEC11025E	25	23,64
BBEC11032E	32	24,47
BBEC11040E	40	34,67
BBEC11050E	50	43,16
BBEC11063E	63	56,79
BBEC11075E	75	94,29
BBEC11110E	110	145,36



Aplicación



BBEL - UNIONES 3 PIEZAS LARGAS

Con cuello largo para soldadura a tope y electrofusión

PE 100 SDR11 - Máxima presión de trabajo permitida 10 bar (agua)

Ref.	Ø	€/Ud.
BBEL11020E	20	19,03
BBEL11025E	25	23,64
BBEL11032E	32	24,47
BBEL11040E	40	34,67
BBEL11050E	50	43,16
BBEL11063E	63	56,79
BBEL11075E	75	97,52
BBEL11110E	110	147,21



Aplicación



DBME - TERMINAL ROSCA HEMBRA LARGO

Con cuello largo para soldadura a tope

PE 100 SDR11 - Máxima presión de trabajo permitida 10 bar (agua)

Ref.	Ø x Rh	€/Ud.
DBME11020012	20 x 1/2"	7,90
DBME11025034	25 x 3/4"	10,24
DBME11032100	32 x 1"	12,02
DBME11040114	40 x 1 1/4"	14,05
DBME11050112	50 x 1 1/2"	17,64
DBME11063200	63 x 2"	20,93



Aplicación



KBFE - TERMINAL ROSCA MACHO CORTO

Con cuello corto para soldadura a tope

PE 100 SDR11 - Máxima presión de trabajo permitida 8 bar (agua)

Ref.	Ø x Rm	€/Ud.
KBFE11020012	20 x 1/2"	11,04
KBFE11025034	25 x 3/4"	13,47
KBFE11032100	32 x 1"	17,01
KBFE11040114	40 x 1 1/4"	18,94
KBFE11050112	50 x 1 1/2"	32,35
KBFE11063200	63 x 2"	38,13

Uniones y adaptadores brida

Carretes de desmontaje

Abrazaderas de reparación

Accesorios metálicos

INFRAESTRUCTURA





Accesorios metálicos

Uniones y adaptadores bridas

Selector de productos según el material de las tuberías para uniones, uniones reducidas y adaptadores de brida

NOTA: Esta tabla sirve de orientación sobre qué productos Viking Johnson son compatibles con qué materiales de tubería. Consulte la documentación del producto para obtener más detalles sobre su idoneidad final.

Grupos de productos		Rango de diámetros nominales (mm)	Fundición dúctil	Fundición	Aceero	Aceero inoxidable	PVC	HEP30	Polipropileno	PEHD/PE80	PEAD/PE100	PRFV	ABS	Cerámica	Hormigón	Fibrocemento	Cobre	Plomo
Gran tolerancia																		
MaxiFit (A, C)	Unión	40 - 700	●	●	●	●	●	●	8	8	8	6	●	1	●	6	1	1
	Adaptador de Brid	40 - 700	●	●	●	●	●	●	8	8	8	6	●	1	●	6	1	1
	Unión Reducida	40 - 700	●	●	●	●	●	●	8	8	8	6	●	1	●	6	1	1
MegaFit (A, C)	Unión	50 - 300	●	●	●	●	●	●				6	●	1	●	6		
	Adaptador de Brida	50 - 300	●	●	●	●	●	●				6	●	1	●	6		
	Unión Reducida	50 - 300	●	●	●	●	●	●				6	●	1	●	6		
UltraGrip (A, B)	Unión	40 - 800	●	●	●		●	●								2		
	Adaptador de Brida	40 - 800	●	●	●		5	5	3	3	3	2				2		
	Uniones Reducidas	40 - 600	●	●	●		5	5	3	3	3	2				2		
	Tapones	50 - 300	●	●	●		5	5	3	3	3	2				2		
	Pecatadaptor	80 - 200	●	●	●		5	5										
Específicos																		
FlexLock (A, B)	Unión	50 - 300	●		●													
	Adaptador de Brid	50 - 300	●		●													
QuickFit (A, C)	Unión	40 - 300	●		●		●	●					●		●			
	Adaptador de Brida	40 - 300	●		●		●	●					●		●			
Gran Diámetro, Desmontadas (A, C)	Unión	350 y mayores	●	●	●	●	●	●				6	●		●	6		
	Adaptador de Brida	350 y mayores	●	●	●	●	●	●				6	●		●	6		
	Unión Reducida	350 y mayores	●	●	●	●	●	●				6	●		●	6		
Soluciones para PE																		
AquaFast (A, B)	Unión	63 - 315					●	●	●	●	●							
	Unión de Gran Diámetro	355 - 450								●	●							
	Adaptador de Brida	63 - 315					●	●	●	●	●							
AquaGrip (A, B)	Adaptador de Brida de Gran Diámetro	355 - 450								●	●							
	Unión	63 - 180							●	●	●							
	Adaptador de Brida	63 - 180							●	●	●							
Adaptador de Brida	Adaptador de Brida	225 - 800								●	●							
	Adaptador de Brida	900 y mayores									●	●						
	Adaptador de Brida	900 y mayores									●	●						
Reparaciones de tuberías																		
EasiRange (A)	EasiClamp / Toma	50 - 600	●	●	●		4	4	4	4	4							
	Universal EasiTee	80 - 300	●	●	●													
	Mattseal Easitee/ Toma	350 - 600	●	●	●													
	Ringseal Easite	350 - 1200	●	●	●		●											
	EasiCollar	300 - 1200	●	●											●	●		
HandiRange (A)	HandiBand	15 - 50			●		●	●					●				●	
	HandiClamp / conexión en T	50 - 600	●	●	●	●	●	●	7	7	7	7	●		●	●	●	●

Nota: Un producto Viking Johnson es apto hasta la presión máxima de trabajo indicada con un material de tubería concreto. (1) Contacte con el departamento de marketing de Viking Johnson para obtener más información.

- (A) El material de tubería es apto dentro de la gama de tolerancias de diámetros internos del producto Viking Johnson.
- (B) Productos autoblocantes - Resisten el esfuerzo de tracción gracias a la presión interna de la tubería.
- (C) Productos flexibles - No resisten el esfuerzo de tracción y se deberá proporcionar un método de contención externo apropiado.
- (D) Productos autoblocantes- Resisten el esfuerzo de tracción de acuerdo con la capacidad de presión sin restricciones del casquillo de PE.
- (2) Solo en versión Flex.
- (3) Solo en versión autoblocante con casquillo rigidizador
- (4) Disponible hasta DN200 (rendimiento limitado).
- (5) Puede ser necesario un casquillo rigidizador - consultar la documentación técnica.
- (6) Puede ser necesario un par de apriete menor - ponerse en contacto con Viking Johnson.
- (7) Rendimiento limitado.
- (8) Tramos cortos de hasta 1 m de PE cuando se utiliza con casquillo rigidizador.



Aplicación



Válido para



AQUAFast - UNIONES

Ref.	Ø	Presión Máx. Trabajo (bar)	€/Ud.
707000000063	63	16	161,30
707000000075	75	16	177,36
707000000090	90	16	192,50
707000000110	110	16	209,61
707000000125	125	16	253,32
707000000140	140	16	284,65
707000000160	160	16	329,30
707000000180	180	16	476,20
707000000200	200	16	624,39
707000000225	225	16	773,83
707000000250	250	16	949,72
707000000280	280	16	1.139,83
707000000315	315	16	1.334,75

Material: Cuerpo de fundición revestido con Rilsan Nylon 11.

Anillo: Fundición Dúctil

Tornillos y Tuercas: Sheraplex.

EPDM para Aplicaciones en Agua



Aplicación



Válido para



AQUAFast - ADAPTADORES DE BRIDA

Ref.	Ø	Presión Máx. Trabajo (bar)	Brida		€/Ud.
			DN	Taladro PN	
708000000063	63	16	50 / 65	10 / 16	113,58
708000000075	75	16	65 / 80	10 / 16	121,93
708000000090	90	16	65 / 80	10 / 16	140,73
708000000110	110	16	100	10 / 16	157,29
708000000125	125	16	100 / 125	10 / 16	190,28
708000000140	140	16	125	10 / 16	222,23
708000000160	160	16	150	10 / 16	251,61
708000000180	180	16	150	10 / 16	332,63
708000000200	200	16	200	10 / 16	425,40
708000000225	225	16	200	10 / 16	515,88
708000000250	250	16	250	10 / 16	621,85
708000000280	280	16	250	10 / 16	746,93
708000000315	315	16	300	10 / 16	882,52

Material: Cuerpo de fundición revestido con Rilsan Nylon 11.

Anillo: Fundición Dúctil

Tornillos y Tuercas:

Sheraplex.

EPDM para Aplicaciones en Agua



Aplicación



Válido para



AQUAFAST - UNIONES PARA GRANDES DIÁMETROS

Ref.	Ø	Presión Máx. Trabajo (bar)	€/Ud.
70700000355	355	16	4.155,28
70700000400	400	16	4.561,59
70700000450	450	16	6.119,76

Material: Cuerpo de fundición revestido con Rilsan Nylon 11

Anillo antitracción: Fundición Dúctil

Tornillos y tuercas: Acero Inoxidable

Junta: EPDM para Aplicaciones en Agua. Ideal para tubos con ovalación

AQUAFAST - ADAPTADORES DE BRIDA PARA GRANDES DIÁMETROS

Ref.	Ø	Presión Máx. Trabajo (bar)	Brida		€/Ud.
			DN	Taladro PN	
708000300355	355	16	300	10 / 16	2.567,71
708000350355	355	16	350	10 / 16	2.619,09
708000350400	400	16	350	10 / 16	2.961,10
708000400400	400	16	400	10 / 16	3.020,37
708000400450	450	16	400	10 / 16	4.148,26
708000450450	450	16	450	10 / 16	4.231,21
708000500450	450	16	500	10 / 16	4.315,83



Aplicación



Válido para



AQUAGRIP - ADAPTADORES DE BRIDA ANTITRACCIÓN-AUTOBLOCANTE DE GRAN DIÁMETRO

SDR11

Ref.	Ø Tubo	Brida		€/Ud.*
		DN	Taladro PN	
161355300110	355	300	10	CONSULTAR
161355300100	355	300	16	5.120,86
161355350100	355	350	16	5.120,86
161400300100	400	300	16	8.117,47
161400350100	400	350	16	8.117,47
161400400110	400	400	10	8.117,47
161400400100	400	400	16	8.117,47
161450350100	450	350	16	10.436,09
161450400110	450	400	10	CONSULTAR
161450400100	450	400	16	10.436,09
161450450110	450	450	10	9.938,87
161450450100	450	450	16	10.436,09
161450500110	450	500	10	CONSULTAR

Material: Cuerpo de fundición revestido con Rilsan Nylon 11

Tornillos y tuercas: hasta d800 Fluoreno, d900 en adelante galvanizado

Junta: EPDM para Aplicaciones en Agua. Ideal para tubos con ovalación



Aplicación



Válido para



MAXIFIT - UNIONES

Ref.	DN	Tolerancia (mm)	Presión Máx. de Trabajo (bar)		€/Ud.*
			Agua	Gas	
701000000005	40	047.9 - 059.5	16	6	85,81
701000000010	50	057.0 - 074.0	16	6	69,35
701000000015	65	063.0 - 085.0	16	6	75,14
701000000020	80	085.0 - 107.0	16	6	85,48
701000000030	100	107.0 - 132.0	16	6	103,06
701000000035	125	132.0 - 158.0	16	6	131,39
701000000045	150	158.0 - 184.0	16	6	138,76
701000000050	175	189.0 - 212.0	16	6	169,37
701000000055	200	218.0 - 244.0	16	6	187,11
701000000065	225	243.0 - 269.0	16	6	222,63
701000000070	250	266.0 - 295.0	16	6	250,35
701000000075	300	315.0 - 349.0	16	6	282,80
701000000090	350	351.0 - 368.0	16	6	1.013,57
701000000095	350	374.5 - 391.5	16	6	1.013,57
701000000096	350	386.0 - 403.0	16	6	1.013,57
701000000097	350	394.3 - 411.3	16	6	1.013,57
701000000098	400	404.8 - 421.8	16	6	1.077,85
701000000099	400	412.0 - 429.0	16	6	1.077,85
701000000100	400	418.2 - 435.2	16	6	1.077,85
701000000101	400	425.0 - 442.0	16	6	1.077,85
701000000102	400	434.5 - 451.5	16	6	1.077,85
701000000103	400	439.0 - 456.0	16	6	1.077,85
701000000104	450	447.0 - 464.0	16	6	1.153,57
701000000105	450	455.0 - 472.0	16	6	1.153,57
701000000106	450	467.0 - 484.0	16	6	1.153,57
701000000110	450	476.0 - 493.0	16	6	1.153,57
701000000111	450	487.0 - 504.3	16	6	1.153,57
701000000112	450	492.0 - 509.0	16	6	1.153,57
701000000115	450	501.9 - 518.9	16	6	1.153,57
701000000118	500	510.0 - 527.0	16	6	1.302,67
701000000119	500	515.0 - 532.0	16	6	1.302,67
701000000120	500	527.0 - 545.0	16	6	1.302,67
701000000121	500	546.0 - 563.0	16	6	1.302,67
701000000122	500	555.3 - 572.3	16	6	1.302,67
701000001122	500	565.0 - 582.0	16	6	1.302,67
701000002122	500	582.2 - 599.2	16	6	1.302,67
701000003122	550	593.0 - 610.0	16	6	1.395,83
701000000123	600	601.0 - 618.0	16	6	1.434,06
701000000124	600	613.0 - 630.0	16	6	1.434,06
701000000125	600	630.0 - 647.0	16	6	1.434,06
701000000126	600	654.0 - 671.0	16	6	1.434,06
701000000130	600	662.0 - 679.0	16	6	1.434,06
701000000131	600	675.0 - 692.0	16	6	1.434,06
701000000132	600	689.0 - 706.0	16	6	1.564,01
701000000133	600	695.0 - 712.0	16	6	1.564,01

* Precios con Junta de EPDM, para Nitrilo consultar

Material: Cuerpo de fundición revestido con Rilsan Nylon 11.

Revestimiento de tornillos y tuercas: Sheraplex.

Juntas: EPDM para Aplicaciones en Agua, Nitrilo para Aplicaciones en Gas.

MAXIFIT-XTRA - UNIONES

Uniones de gran tolerancia (iguales que Maxifit) pero con un 50% más de longitud para incrementar seguridad de unión.

Disponibles desde DN50 a DN300



Aplicación



Válido para



MAXISTEP - UNIONES REDUCIDAS

Ref.	DN	Tolerancia (mm)		Presión Máx. de Trabajo (bar)		€/Ud.
		Extremo Peq.	Extremo Gran.	Agua	Gas	
70300000010	050 / 065	057.0 - 074.0	063.0 - 085.0	16	6	213,80
70300000015	050 / 080	057.0 - 074.0	085.0 - 107.0	16	6	218,73
70300000016	065 / 080	063.0 - 085.0	085.0 - 107.0	16	6	226,69
70300000020	080 / 100	085.0 - 107.0	107.0 - 132.0	16	6	233,81
70300000040	100 / 125	107.0 - 132.0	132.0 - 158.0	16	6	244,78
70300000050	125 / 150	132.0 - 158.0	158.0 - 184.0	16	6	272,15
70300000065	150 / 175	158.0 - 184.0	189.0 - 212.0	16	6	322,57
70300000075	175 / 200	189.0 - 212.0	218.0 - 244.0	16	6	409,20
70300000080	200 / 225	218.0 - 244.0	243.0 - 269.0	16	6	470,85
70300000085	225 / 250	243.0 - 269.0	266.0 - 295.0	16	6	478,76
70300000090	300 / 350	315.0 - 332.0	351.0 - 368.0	16	6	1.911,96
70300000095	300 / 350	315.0 - 332.0	367.0 - 384.0	16	6	1.997,19
70300000100	350 / 350	351.0 - 368.0	374.5 - 391.5	16	6	2.258,03
70300000115	350 / 350	374.5 - 391.5	394.3 - 411.3	16	6	1.247,08
70300000116	350 / 400	374.5 - 391.5	412.0 - 429.0	16	6	2.476,15
70300000117	350 / 400	386.0 - 403.0	412.0 - 429.0	16	6	1.309,69
70300000118	350 / 400	394.3 - 411.3	404.8 - 421.8	16	6	2.434,77
703000002118	350 / 400	394.3 - 411.3	418.2 - 435.2	16	6	1.309,69
703000003118	350 / 400	394.3 - 411.3	425.0 - 442.0	16	6	2.550,08
703000000119	400 / 400	404.8 - 421.8	418.2 - 435.2	16	6	1.309,69
703000000120	400 / 400	404.8 - 421.8	425.0 - 442.0	16	6	1.333,72
703000000121	400 / 400	404.8 - 421.8	434.5 - 451.4	16	6	2.603,57
703000000122	400 / 400	412.0 - 429.0	425.0 - 442.0	16	6	2.550,08
703000000123	400 / 400	418.2 - 435.2	434.5 - 451.4	16	6	2.603,57
703000000125	400 / 400	425.0 - 442.0	434.5 - 451.4	16	6	1.333,72
703000000130	400 / 400	425.0 - 442.0	447.2 - 464.2	16	6	1.333,72
703000000131	400 / 400	439.0 - 456.0	467.0 - 484.0	16	6	1.433,26
703000000135	400 / 450	425.0 - 442.0	455.0 - 472.0	16	6	2.842,50
703000000136	400 / 450	425.0 - 442.0	476.0 - 493.0	16	6	2.908,68
703000000137	400 / 450	425.0 - 442.0	487.3 - 504.3	16	6	3.574,69
703000001137	400 / 500	425.0 - 442.0	555.3 - 572.3	16	6	3.635,78
703000002137	400 / 500	425.0 - 442.0	565.0 - 582.0	16	6	1.436,97
703000002138	450 / 450	447.2 - 464.2	455.0 - 472.0	16	6	2.722,93
703000000139	450 / 450	447.2 - 464.2	476.0 - 493.0	16	6	2.842,50
703000000140	450 / 450	476.0 - 493.0	487.3 - 504.3	16	6	1.585,03
703000000145	450 / 450	476.0 - 493.0	501.9 - 518.9	16	6	1.585,03
703000000150	450 / 450	476.0 - 493.0	510.0 - 527.0	16	6	1.585,03
703000000151	450 / 500	492.0 - 509.0	527.0 - 544.0	16	6	1.936,19
703000000154	500 / 500	510.0 - 527.0	527.0 - 544.0	16	6	1.936,19
703000000155	500 / 500	527.0 - 544.0	540.1 - 557.1	16	6	1.753,23
703000000160	500 / 500	527.0 - 544.0	555.3 - 572.3	16	6	1.753,23



Aplicación



Válido para



MAXISTEP - UNIONES REDUCIDAS

Ref.	DN	Tolerancia (mm)		Presión Máx. de Trabajo (bar)		€/Ud.
		Extremo Peq.	Extremo Gran.	Agua	Gas	
703000000165	500 / 500	527.0 - 544.0	566.5 - 583.5	16	6	1.753,23
703000000170	500 / 500	527.0 - 544.0	582.2 - 599.2	16	6	1.753,23
703000000171	500 / 600	527.0 - 544.0	598.0 - 615.0	16	6	3.841,65
703000000171	500 / 600	527.0 - 544.0	601.0 - 618.0	16	6	3.862,11
7030000002171	500 / 500	546.0 - 563.0	590.5 - 607.5	16	6	1.844,41
7030000003171	500 / 500	565.0 - 582.0	582.2 - 599.2	16	6	3.742,57
703000000172	600 / 600	601.0 - 618.0	630.0 - 647.0	16	6	1.844,41
703000000173	600 / 600	601.0 - 618.0	645.2 - 662.2	16	6	1.844,41
703000000174	600 / 600	618.0 - 635.0	630.0 - 647.0	16	6	1.844,41
703000000175	600 / 600	630.0 - 647.0	645.2 - 662.2	16	6	1.844,41
703000000180	600 / 600	630.0 - 647.0	662.0 - 679.0	16	6	1.844,41
703000000185	600 / 600	630.0 - 647.0	675.0 - 692.0	16	6	1.844,41
703000000186	600 / 600	654.0 - 671.0	710.0 - 727.0	16	6	2.151,97
703000000190	700 / 700	733.0 - 750.0	741.0 - 758.0	16	6	2.364,20

* Precios con Junta de EPDM, para Nitrilo consultar



Aplicación



Válido para



MAXIDAPTOR - ADAPTADORES DE BRIDA

Ref.	DN	Tolerancia (mm)	Brida		Presión Máx. de Trabajo (bar)		€/Ud.
			DN	Taladro PN	Agua	Gas	
			70200000005	50	057.0 - 074.0	50	
70200000010	65	063.0 - 085.0	60 / 65 / 80	10 / 16	16	6	94,68
70200000020	80	085.0 - 107.0	80	10 / 16	16	6	96,28
70200000030	100	107.0 - 132.0	100	10 / 16	16	6	100,97
70200000035	125	132.2 - 158.0	125 / 150	10 / 16	16	6	136,79
70200000045	150	158.0 - 184.0	150	10 / 16	16	6	139,67
70200000050	175	189.0 - 212.0	200	10 / 16	16	6	186,32
70200000055	200	218.0 - 244.0	200	10 / 16	16	6	195,53
70200000060	225	243.0 - 269.0	250	10 / 16	16	6	244,49
70200000065	250	266.0 - 295.0	250	10 / 16	16	6	258,85
70200000070	300	315.0 - 349.0	300	10 / 16	16	6	306,01
70200000075	350	348.5 - 365.5	350	16	16	6	1.252,82
70200000080	350	351.0 - 368.0	350	10	16	6	1.252,82
70200000084	350	351.0 - 368.0	350	16	16	6	1.252,82
70200000085	350	374.5 - 391.5	350	10	16	6	1.252,82
70200000090	350	374.5 - 391.5	350	16	16	6	1.252,82
70200000095	350	394.3 - 411.3	350	10	16	6	1.252,82
70200000100	350	394.3 - 411.3	350	16	16	6	1.252,82
70200000101	350	394.3 - 411.3	400	10	16	6	1.394,89
70200000102	350	394.3 - 411.3	400	16	16	6	1.394,89
70200000104	400	404.8 - 421.8	400	10	16	6	1.394,89
70200000105	400	404.8 - 421.8	400	16	16	6	1.394,89
70200000106	400	418.2 - 435.2	400	10	16	6	1.394,89
70200000107	400	418.2 - 435.2	400	16	16	6	1.394,89
70200000108	400	425.0 - 442.0	400	10	16	6	1.394,89
70200000110	400	425.0 - 442.0	400	16	16	6	1.394,89
70200000111	400	434.4 - 451.4	400	10	16	6	1.394,89
70200000115	400	434.4 - 451.4	400	16	16	6	1.394,89
70200000116	400	447.2 - 464.2	400	10	16	6	1.394,89
70200000120	400	447.2 - 464.2	400	16	16	6	1.394,89
70200000125	450	455.0 - 472.0	450	10	16	6	1.655,43
70200000130	450	455.0 - 472.0	450	16	16	6	1.655,43
70200000131	450	476.0 - 493.0	450	10	16	6	1.655,43
70200000135	450	476.0 - 493.0	450	16	16	6	1.655,43
70200000136	450	487.3 - 504.3	450	10	16	6	1.655,43
70200000140	450	487.3 - 504.3	450	16	16	6	1.655,43
70200000141	450	501.9 - 518.9	450	10	16	6	1.655,43
70200000142	450	501.9 - 518.9	450	16	16	6	1.655,43
70200000143	450	510.0 - 527.0	500	10	16	6	1.931,25
70200000155	450	510.0 - 527.0	500	16	16	6	1.931,25
70200000156	450	501.9 - 518.9	500	10	16	6	1.931,25



Aplicación



Válido para



MAXIDAPTOR - ADAPTADORES DE BRIDA

Ref.	DN	Tolerancia (mm)	Brida		Presión Máx. de Trabajo (bar)		€/Ud.
			DN	Taladro PN	Agua	Gas	
70200000145	450	501.9 - 518.9	500	16	16	6	1.931,25
70200000150	450	510.0 - 527.0	450	10	16	6	1.931,25
70200000159	500	527.0 - 544.0	500	10	16	6	1.931,25
70200000160	500	527.0 - 544.0	500	16	16	6	1.931,25
70200000161	500	540.1 - 557.1	500	10	16	6	1.931,25
70200000165	500	540.1 - 557.1	500	16	16	6	1.931,25
70200000166	500	555.3 - 572.3	500	10	16	6	1.931,25
70200000170	500	555.3 - 572.3	500	16	16	6	1.931,25
70200000171	500	566.5 - 583.5	500	10	16	6	1.931,25
70200000175	500	566.5 - 583.5	500	16	16	6	1.931,25
70200000180	500	582.2 - 599.2	500	10	16	6	1.931,25
70200000185	500	582.2 - 599.2	500	16	16	6	1.931,25
70200000187	600	601.0 - 618.0	600	10	16	6	2.295,15
70200000188	600	601.0 - 618.0	600	16	16	6	2.295,15
70200000189	600	630.5 - 647.5	600	10	16	6	2.295,15
70200000190	600	630.5 - 647.5	600	16	16	6	2.295,15
70200000191	600	645.2 - 662.2	600	10	16	6	2.295,15
70200000195	600	645.2 - 662.2	600	16	16	6	2.295,15
70200000196	600	662.0 - 679.0	600	10	16	6	2.295,15
70200000200	600	662.0 - 679.0	600	16	16	6	2.295,15

* Precios con Junta de EPDM, para Nitrilo consultar



Aplicación



Válido para



ULTRAGRIP - UNIONES DE GRAN TOLERANCIA

Ref.	DN	Tolerancia (mm)	Presión Máx. de Trabajo (bar)		€/Ud.*
			Agua	Gas	
15005000010	40	043.5 - 063.5	16	4	312,65
15004000000	50	048.0 - 071.0	16	4	338,89
15006500020	65	063.0 - 083.7	16	4	365,28
15008000030	80	085.7 - 107.0	16	4	419,38
15010000040	100	107.2 - 133.2	16	4	493,36
15012500050	125	132.2 - 160.2	16	4	676,28
15015000060	150	158.2 - 192.2	16	4	842,07
15017500070	175	192.2 - 226.9	16	4	1.155,02
15020000080	200	218.1 - 256.0	16	4	1.254,31
15025000090	250	266.2 - 310.0	16	4	1.614,80
15030000100	300	315.0 - 356.0	16	4	1.919,67
15035000110	350	352.2 - 396.0	10	4	3.238,58
15040000120	400	398.2 - 442.0	10	4	3.486,43
15045000130	450	448.0 - 492.0	10	**	5.270,74
15050000140	500	498.0 - 552.0	10	**	6.350,17
15050000141	500	558.0 - 608.0	10	**	7.039,85
15060000150	600	604.0 - 648.0	10	**	7.827,94
15060000151	600	676.0 - 726.0	10	**	8.380,86
15070000160	700	700-735	16	**	Consultar
15070000161	700	727-762	16	**	Consultar
15070000162	700	750-785	16	**	Consultar
15080000170	800	789 - 824	16	**	Consultar
15080000171	800	825 - 860	16	**	Consultar
15080000172	800	853 - 888	16	**	Consultar

* Precios con Junta de EPDM, para Nitrilo consultar

** No apto para gas

Permite convertirla en no autoblocante.

Utiliza misma mordaza para todo tipo de materiales compatibles. Para aplicaciones en PE y PVC.

Material: Cuerpo de fundición revestido con Rilsan Nylon 11.

Revestimiento de tornillos: Capa de lubricante en seco.

Revestimiento de tuercas: Decromet.

Mordaza: Copolímero de Acetal.

Deflexión angular de hasta 8°.

Juntas: EPDM para Aplicaciones en Agua, Nitrilo para Aplicaciones en Gas.



Aplicación



Válido para



ULTRAGRIP - UNIONES REDUCIDAS DE GRAN TOLERANCIA

Ref.	DN	Tolerancia (mm)		Presión Máx. de Trabajo (bar)		€/Ud.*
		Extremo Peq.	Extremo Gran.	Agua	Gas	
152032040000	032 / 040	036.0 - 046.0	043.5 - 063.5	16	4	389,32
152080100000	080 / 100	085.7 - 107.0	107.2 - 133.2	16	4	560,87
152100125000	100 / 125	107.2 - 133.2	132.2 - 160.2	16	4	644,17
152100150000	100 / 150	107.2 - 133.2	158.2 - 192.2	16	4	809,21
152125150000	125 / 150	132.2 - 160.2	158.2 - 192.2	16	4	840,68
152150175000	150 / 175	158.2 - 192.2	192.9 - 226.2	16	4	1.097,69
152175200000	175 / 200	192.9 - 226.9	218.1 - 256.0	16	4	1.383,82
152200250000	200 / 250	218.1 - 256.0	266.2 - 310.0	16	4	1.624,75
152250300000	250 / 300	266.2 - 310.0	315.0 - 356.0	16	4	1.986,77
152400450000	400 / 450	398.0 - 442.0	448.0 - 492.0	10	**	4.147,47
152500500000	500 / 500	498.0 - 552.0	558.0 - 608.0	10	**	5.221,74
152600000000	600 / 600	604.0 - 648.0	676.0 - 726.0	10	**	7.033,83

* Precios con Junta de EPDM, para Nitrilo consultar.

** No apto para gas

Permite convertirla en no autoblocante.

Utiliza misma mordaza para todo tipo de materiales compatibles. Para aplicaciones en PE y PVC.

Material: Cuerpo de fundición revestido con Rilsan Nylon 11.

Revestimiento de tornillos: Capa de lubricante en seco.

Revestimiento de tuercas: Decromet.

Mordaza: Copolímero de Acetal.

Deflexión angular de hasta 8°.

Juntas: EPDM para Aplicaciones en Agua, Nitrilo para Aplicaciones en Gas.



Aplicación



Válido para



ULTRAGRIP - ADAPTADORES DE BRIDAS DE GRAN TOLERANCIA

Ref.	DN	Tolerancia (mm)	Brida		Presión Máx. de Trabajo (bar)		€/Ud.*
			DN	Taladro PN	Agua	Gas	
15105000010	40	043.5 - 063.5	50	10 / 16	16	4	269,49
15104000000	50	048.0 - 071.0	50	10 / 16	16	4	316,30
15106500020	65	063.0 - 083.7	65	10 / 16	16	4	329,10
15108000030	80	085.7 - 107.0	80	10 / 16	16	4	380,23
15110000040	100	107.2 - 133.2	100	10 / 16	16	4	470,36
15112500050	125	132.2 - 160.2	125	10 / 16	16	4	596,06
15115000060	150	158.2 - 192.2	150	10 / 16	16	4	712,63
15117500070	175	192.2 - 226.9	200	10 / 16	16	4	916,86
15120000080	200	218.1 - 256.0	200	10 / 16	16	4	988,96
15125000090	250	266.2 - 310.0	250	10 / 16	16	4	1.290,43
15130000100	300	315.0 - 356.0	300	10 / 16	16	4	1.597,98
15135000110	350	352.2 - 396.0	350	10 / 16	10	4	2.489,61
15140000120	400	398.2 - 442.0	400	10 / 16	10	4	2.840,82
15140000121	450	448.0 - 492.0	400	10 / 16	10	**	4.297,34
15150000130	500	498.0 - 552.0	500	10 / 16	10	**	5.115,90
15150000131	500	558.0 - 608.0	500	10 / 16	10	**	5.494,87
15160000140	600	604.0 - 648.0	600	10 / 16	10	**	6.278,23
15160000141	600	676.0 - 726.0	600	10 / 16	10	**	7.142,65
15170000150	700	700-735	700	10 / 16	16	**	Consultar
15170000151	700	727-762	700	10 / 16	16	**	Consultar
15170000152	700	750-785	700	10 / 16	16	**	Consultar
15180000160	800	789 - 824	800	10 / 16	16	**	Consultar
15180000161	800	825 - 860	800	10 / 16	16	**	Consultar
15180000162	800	853 - 888	800	10 / 16	16	**	Consultar

* Precios con Junta de EPDM, para Nitrilo consultar.

** No apto para gas

Permite convertirla en no autoblocante.

Utiliza misma mordaza para todo tipo de materiales compatibles. Para aplicaciones en PE y PVC.

Material: Cuerpo de fundición revestido con Rilsan Nylon 11.

Revestimiento de tornillos: Capa de lubricante en seco.

Revestimiento de tuercas: Decromet.

Mordaza: Copolímero de Acetal.

Deflexión angular de hasta 8°.

Juntas: EPDM para Aplicaciones en Agua, Nitrilo para Aplicaciones en Gas.



Aplicación



Válido para



ULTRAGRIP - CASQUILLOS ALINEADORES DE ACERO

SDR11

Ref.	Ø	€/Ud.
153040011100	40	20,65
153050011100	50	25,88
153063011100	63	76,40
153075011100	75	79,50
153090011100	90	83,61
153110011100	110	89,16
153125011100	125	97,44
153140011100	140	104,02
153160011100	160	111,28
153180011100	180	121,67
153200011100	200	142,25
153225011100	225	158,36
153250011100	250	172,03
153280011100	280	191,24
153315011100	315	216,77
153355011100	355	246,17
153400011100	400	337,33
153450011100	450	678,58
153500011100	500	827,85
153560011100	560	976,82
153630011100	630	1.074,46
156710011100	710	1.181,94

SDR17

Ref.	Ø	€/Ud.
153063017100	63	76,40
153075017100	75	79,50
153090017100	90	83,61
153110017100	110	89,16
153125017100	125	97,44
153140017100	140	104,02
153160017100	160	111,28
153180017100	180	121,67
153200017100	200	142,25
153225017100	225	158,36
153250017100	250	172,03
153280017100	280	191,24
153315017100	315	216,77
153355017100	355	246,17
153400017100	400	337,33
153450017100	450	678,58
153500017100	500	827,85
153560017100	560	976,82
153630017100	630	1.074,46
153710017100	710	1.181,94

Para aplicaciones con PE y PVC es necesario el uso de casquillos alineadores en toda la gama ULTRAGRIP



Aplicación



Válido para



QUICKFIT - UNIONES

Ref.	DN	Ø Tubo	Presión Máx.Trabajo (bar)	€/Ud.*
720000040040	40	047.9 - 051.3	40	154,48
720000040050	50	059.5 - 063.3	40	197,58
720000040065	65	075.3 - 079.1	40	260,13
720000040080	80	088.1 - 091.9	40	283,51
721000040080	80	095.8 - 100.2	40	283,51
720000040100	100	107.2 - 111.0	40	343,48
721000040100	100	113.5 - 120.2	40	343,48
720000040125	125	138.9 - 142.7	40	440,59
720000025150	150	158.2 - 162.0	25	486,71
721000025150	150	167.5 - 172.3	25	486,71
720000025175	175	192.2 - 196.7	25	500,23
720000025200	200	218.3 - 224.4	25	570,71
720000025250	250	272.2 - 276.5	25	674,13
720000025300	300	323.1 - 328.6	25	823,62

* Precios con Junta de EPDM, para Nitrilo consultar.

Especialmente diseñados para grandes presiones (hasta 46 bar).

Material: Cuerpo de fundición revestido con Rilsan Nylon 11.

Revestimiento de tornillos y tuercas: Sheraplex.

Juntas: EPDM para Aplicaciones en Agua, Nitrilo para Aplicaciones en Gas.



Aplicación



Válido para



QUICKFIT - ADAPTADORES DE BRIDA

Ref.	DN	Ø Tubo	Material	Brida		€/Ud.*
				DN	Taladro PN	
722000000050	50	059.5 - 063.3	Acero/PVC /PVCu	50	10/16/25/40	289,47
722000000065	65	075.3 - 079.1	Acero	65	10/16	375,76
722000000080	80	088.1 - 091.9	Acero/PVC /PVCu	80	10/16/25/40	433,06
723000000080	80	095.8 - 100.2	Fund. Dúctil	80	10/16/25/40	433,06
722000000100	100	107.2 - 111.0	Acero/PVC	100	10/16	460,73
723000000100	100	113.5 - 120.2	Acero/PVCu/Fund. Dúctil	100	10/16	460,73
722000000125	125	138.9 - 142.7	Acero/PVC/PVCu	125	10/16	515,75
722000000150	150	158.2 - 162.0	Acero/PVC/PVCu	150	10/16	587,51
723000000150	150	167.5 - 172.3	Acero/Fund. Dúctil	150	10/16	587,51
722000000200	200	192.2 - 196.7	Acero/PVCu	200	10/16	696,84
723000000200	200	218.3 - 224.4	Acero/PVCu/Fund. Dúctil	200	10/16	803,20
722000000250	250	272.2 - 276.5	Acero/PVCu/Fund. Dúctil	250	10/16	1.059,73
722000000300	300	323.1 - 328.6	Acero/PVCu/Fund. Dúctil	300	10/16	1.286,94

* Precios con Junta de EPDM, para Nitrilo consultar.

Especialmente diseñados para grandes presiones (hasta 46 bar).

Material: Cuerpo de fundición revestido con Rilsan Nylon 11.

Revestimiento de tornillos y tuercas: Sheraplex.

Juntas: EPDM para Aplicaciones en Agua, Nitrilo para Aplicaciones en Gas.



Aplicación



Válido para

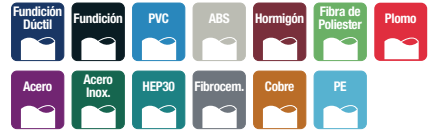

CARRETES DE DESMONTAJE

Ref.	DN	PN Brida	€/Ud.*
17000050100	50	10 / 16	315,42
17000065100	65	10 / 16	319,41
17000080100	80	10 / 16	382,72
17000100100	100	10 / 16	418,77
17000125100	125	10 / 16	522,29
17000150100	150	10 / 16	627,22
17000200110	200	10	819,62
17000200116	200	16	910,11
17000250110	250	10	1.099,04
17000250116	250	16	1.220,93
17000300110	300	10	1.291,36
17000300116	300	16	1.435,63
17000350110	350	10	1.621,36
17000350116	350	16	1.802,34
17000400110	400	10	1.988,27
17000400116	400	16	2.211,32
17000450110	450	10	2.211,32
17000450116	450	16	2.464,21
17000500110	500	10	2.694,75
17000500116	500	16	2.999,70
17000600110	600	10	3.269,92
17000600116	600	16	3.641,82
17000700110	700	10	3.869,86
17000700116	700	16	4.318,60
17000800110	800	10	5.094,58
17000800116	800	16	5.654,83
17000900110	900	10	6.058,91
17000900116	900	16	6.728,29
17001000110	1000	10	10.792,91
17001000116	1000	16	11.988,37
17001100110	1100	10	15.360,52
17001100116	1100	16	20.386,94
17001200110	1200	10	27.312,08
17001200116	1200	16	32.288,26
17001400110	1400	10	35.676,83
17001400116	1400	16	38.388,85
17001500110	1500	10	42.853,90
17001500116	1500	16	46.077,39
17001600110	1600	10	50.646,82
17001600116	1600	16	54.459,10
17001800110	1800	10	68.157,11
17001800116	1800	16	73.254,75
17002000110	2000	10	85.792,01
17002000116	2000	16	92.309,59

* Otras presiones consultar

Para válvulas, bombas y medidores.

Posibilidad de otras dimensiones y PN bajo petición.

Material: Acero revestido con Rilsan Nylon 11.



Aplicación



Válido para



HANDICLAMP - ABRAZADERAS SIMPLES DE REPARACIÓN EN ACERO INOXIDABLE

DN	Tolerancia (mm)	Presión Máx. de Trabajo (bar)		L-150 mm		L-200 mm	
		Agua	Gas	Ref.	€/Ud	Ref.	€/Ud
32	044.0 - 048.0	24	6	706000000004	85,40	706000200004	98,00
32	048.0 - 052.0	24	6	706000000005	87,52	706000200005	98,86
40	054.0 - 058.0	24	6	706000000010	87,52	706000200010	98,86
40	058.0 - 064.0	24	6	706000000014	89,05	706000200014	103,42
50	060.0 - 067.0	24	6	706000000015	89,05	706000200015	103,42
50	063.0 - 070.0	24	6	706000000016	89,05	706000200016	103,42
50	068.0 - 076.0	24	6	706000000020	91,20	706000200020	105,56
65	075.0 - 083.0	24	6	706000000035	94,55	706000200035	109,54
65	082.0 - 089.0	20	5	706000000040	94,55	706000200040	109,54
80	087.0 - 096.0	20	5	706000000045	96,16	706000200045	110,56
80	095.0 - 105.0	20	5	706000000055	97,42	706000200055	111,65
90	102.0 - 112.0	20	5	706000150060	97,83	706000000060	125,23
100	113.0 - 123.0	20	5	706000150075	100,63	706000000075	128,39
100	120.0 - 130.0	16	4	706000150085	114,48	706000000085	131,82
125	132.0 - 142.0	16	4	-	-	706000000095	133,84
125	135.0 - 145.0	16	4	-	-	706000000100	133,84
125	147.0 - 157.0	16	4	-	-	706000000105	140,45
150	151.0 - 161.0	16	4	-	-	706000000110	141,59
150	160.0 - 170.0	16	4	-	-	706000000115	141,59
150	167.0 - 178.0	16	4	-	-	706000000125	144,19
150	176.0 - 187.0	16	4	-	-	706000000140	150,72
175	186.0 - 196.0	16	4	-	-	706000000150	160,25
175	193.0 - 203.0	16	4	-	-	706000000155	160,81
175	200.0 - 210.0	16	4	-	-	706000000160	160,81
200	215.0 - 225.0	16	4	-	-	706000000170	175,20
200	219.0 - 229.0	16	4	-	-	706000000175	175,20
225	230.0 - 240.0	10	2,5	-	-	-	-
225	237.0 - 247.0	10	2,5	-	-	-	-
225	240.0 - 250.0	10	2,5	-	-	-	-
225	250.0 - 260.0	10	2,5	-	-	-	-
225	257.0 - 267.0	10	2,5	-	-	-	-

También disponibles en L-300 mm y L-400 mm

225	261.0 - 271.0	10	2,5	-	-	-	-
250	270.0 - 280.0	10	2,5	-	-	-	-
250	280.0 - 291.0	6	1,5	-	-	-	-
250	290.0 - 300.0	6	1,5	-	-	-	-
300	300.0 - 310.0	6	1,5	-	-	-	-
300	310.0 - 320.0	6	1,5	-	-	-	-
300	315.0 - 325.0	6	1,5	-	-	-	-
300	320.0 - 330.0	6	1,5	-	-	-	-
300	330.0 - 340.0	6	1,5	-	-	-	-
300	340.0 - 350.0	6	1,5	-	-	-	-
300	350.0 - 360.0	6	1,5	-	-	-	-

También disponibles en L-300 mm y L-400 mm



Aplicación



Válido para



HANDICLAMP - ABRAZADERAS DOBLES DE REPARACIÓN EN ACERO INOXIDABLE

DN	Tolerancia (mm)	Presión Máx. de Trabajo (bar)		L-200 mm		L-300 mm	
		Agua	Gas	Ref.	€/Ud	Ref.	€/Ud
80	088.0 - 110.0	20	5	70600000335	195,84	706000300335	290,07
100	108.0 - 128.0	20	5	70600000337	199,61	706000300337	298,79
100	113.0 - 133.0	20	5	70600000338	206,21	706000300338	308,95
100	120.0 - 140.0	20	5	70600000339	206,20	706000300339	303,03
125	130.0 - 150.0	16	4	70600000340	211,66	706000300340	308,78
125	140.0 - 160.0	16	4	70600000342	214,33	706000300342	317,48
150	150.0 - 170.0	16	4	70600000364	219,02	706000300364	326,03
150	159.0 - 180.0	16	4	70600000343	221,90	706000300343	329,52
150	168.0 - 189.0	16	4	70600000346	223,75	706000300346	333,43
150	170.0 - 190.0	16	4	70600000347	224,03	706000300347	332,50
150	175.0 - 195.0	16	4	70600000357	226,03	706000300357	334,25
175	190.0 - 210.0	16	4	70600000348	227,84	706000300348	341,59
200	205.0 - 225.0	16	4	70600000349	252,52	706000300349	336,38
200	210.0 - 230.0	16	4	70600000350	252,52	706000300350	343,00
200	216.0 - 238.0	16	4	70600000351	253,67	706000300351	346,91
200	220.0 - 242.0	10	2,5	70600000352	254,05	706000300352	350,25
225	240.0 - 260.0	10	2,5	70600000353	262,63	706000300353	376,91
225	243.0 - 263.0	10	2,5	70600000354	266,79	706000300354	385,22
225	255.0 - 275.0	10	2,5	706000200205	271,74	706000000205	382,97
250	272.0 - 292.0	10	2,5	706000200215	281,75	706000000215	379,64
250	282.0 - 302.0	6	1,5	706000200220	293,25	706000000220	385,10
250	295.0 - 315.0	6	1,5	706000200225	310,53	706000000225	382,07
300	307.0 - 327.0	6	1,5	-	-	706000000229	382,97
300	315.0 - 335.0	6	1,5	-	-	706000000230	416,02
300	319.0 - 339.0	6	1,5	-	-	706000000234	416,02
300	322.0 - 344.0	6	1,5	-	-	706000000235	436,53
300	333.0 - 353.0	6	1,5	-	-	706000000413	439,07
300	341.0 - 361.0	6	1,5	-	-	706000000362	464,81
350	365.0 - 385.0	5	1,3	-	-	706000000363	485,21

También disponibles en L-300 mm y L-400 mm



Aplicación



Válido para



HANDICLAMP - ABRAZADERAS TRIPLES DE REPARACIÓN EN ACERO INOXIDABLE (L-400)

Ref.	Tolerancia	€/Ud.*
70600000240	340.0 - 370.0	Consultar
70600000423	385.0 - 415.0	725,53
70600000245	395.0 - 425.0	839,26
70600000250	440.0 - 470.0	862,45
70600000255	475.0 - 505.0	1.391,06
70600000260	530.0 - 560.0	1.669,27
70600000421	535.0 - 565.0	2.656,58

Válvulas

Trampillones

Accesorios

Ventosas

Hidrantes y bocas de riego

Collarines, abrazaderas, tomas en carga

Bridas

Válvulas y accesorios de fundición

INFRAESTRUCTURA





INFRAESTRUCTURA

Válvulas y accesorios de fundición

Válvulas de compuerta



* Para válvulas de cierre elástico
** ACS sólo para válvulas azules



* Para válvulas de cierre elástico
** ACS sólo para válvulas azules

NEXUS - VÁLVULAS DE COMPUERTA DE CIERRE ELÁSTICO CON BRIDAS

Serie 14 - PN16

Referencia	DN	€/Ud.
10729010	50	135,81
10729015	65	169,57
10729020	80	176,65
10729025	100	218,93
10729030	125	320,98
10729035	150	358,46
10729045	200	612,28
10729055	250	CONSULTAR
10729065	300	CONSULTAR

Disponible en PN10 y PN16

Con eje en acero inoxidable AISI 316 L +10%



También disponible en color rojo para saneamiento y aguas residuales. **PRECIOS CONSULTAR**

NEXUS - VÁLVULAS DE COMPUERTA DE CIERRE ELÁSTICO CON BRIDAS

Serie 15 - PN16

Referencia	DN	€/Ud.
10733010	50	153,63
10733015	65	174,78
10733020	80	197,04
10733025	100	238,99
10733030	125	359,96
10733035	150	423,40
10733045	200	699,50
10733055	250	CONSULTAR
10733065	300	CONSULTAR

Disponible en PN10 y PN16

Con eje en acero inoxidable AISI 316 L +10%



También disponible en color rojo para saneamiento y aguas residuales. **PRECIOS CONSULTAR**



* Para válvulas de cierre elástico
** ACS sólo para válvulas azules



También disponible en color rojo para saneamiento y aguas residuales. **PRECIOS CONSULTAR**
Cierre izquierda disponible bajo pedido

MODELO 3000 - VÁLVULAS DE COMPUERTA DE CIERRE ELÁSTICO CON BRIDAS

Serie 14 - PN16

Referencia	DN	€/Ud.
66604000001	40	148,06
66605000001	50	148,06
66606000001	60	185,54
66606500001	65	185,54
66608000001	80	195,18
66610000001	100	237,86
66612500001	125	352,14
66615000001	150	393,34
66620000001	200	701,32

Referencia	DN	€/Ud.
66625000001	250	1.068,70
66630000001	300	1.532,55
66635000001	350	3.673,67
66640000001	400	4.601,37
66645000001	450	7.681,30
66650000001	500	8.312,12

Disponible en PN10 y PN16

Con eje en acero inoxidable AISI 316 L +10%

Cierre izquierda disponible bajo pedido



* Para válvulas de cierre elástico
** ACS sólo para válvulas azules

NEXUS BLOCKPLUS - VÁLVULAS DE COMPUERTA DE CIERRE ELÁSTICO CON EXTREMOS ANTITRACCIÓN PARA TUBOS DE PE/PVC

PN16

Referencia	DN	DN ext. Tubo	€/Ud.
10720700	50	63	436,03
10720705	65	75	497,06
10720710	80	90	549,38
10720714	100	110	697,63
10720720	125	125	959,24
10720725	150	160	1.116,20
10720730	200	200	1.656,87

Con eje en acero inoxidable AISI 316 L +10%



* Para válvulas de cierre elástico
** ACS sólo para válvulas azules

MODELO 3000 - VÁLVULAS DE COMPUERTA DE CIERRE ELÁSTICO CON BRIDAS

Serie 15 - PN25

Referencia	DN	€/Ud.
666040025001	40	307,99
666050025001	50	307,99
666060025001	60	348,81
666065025001	65	348,81
666080025001	80	415,61
666100025001	100	486,11
666125025001	125	701,32
666150025001	150	823,80
666200025001	200	1.194,86
666250025001	250	1.914,76
666300025001	300	2.786,79

Con eje en acero inoxidable AISI 316 L +10%
Cierre izquierda disponible bajo pedido



* Para válvulas de cierre elástico
** ACS sólo para válvulas azules



También disponible en color rojo para saneamiento y aguas residuales. **PRECIOS CONSULTAR**
Cierre izquierda disponible bajo pedido

MODELO 3000 - VÁLVULAS DE COMPUERTA DE CIERRE ELÁSTICO CON BRIDAS

Serie 15 - PN16

Referencia	DN	€/Ud.
666040000002	40	168,83
666050000002	50	168,83
666060000002	60	192,96
666065000002	65	192,96
666080000002	80	217,07
666100000002	100	263,47
666125000002	125	397,05
666150000002	150	463,84
666200000002	200	771,84

Referencia	DN	€/Ud.
666250000002	250	1.209,73
666300000002	300	1.988,97
666350000002	350	4.170,90
666400000002	400	4.824,00
666450000002	450	8.378,93
666500000002	500	9.035,72
666600000002	600	14.472,00

Disponible en PN10 y PN16
Con eje en acero inoxidable AISI 316 L +10%
Cierre izquierda disponible bajo pedido



MODELO 3000 - VÁLVULAS DE COMPUERTA METÁLICA

PN40

Referencia	DN	€/Ud.
666040040008	40	476,13
666050040008	50	540,63
666060040008	60	631,34
666065040008	65	631,34
666080040008	80	833,67
666100040008	100	1.151,09
666125040008	125	1.555,71
666150040008	150	2.012,63
666200040008	200	3.334,64
666250040008	250	5.054,29
666300040008	300	6.130,39
666350040008	350	11.034,68
666400040008	400	14.873,36
666450040008	450	16.327,90
666500040008	500	26.631,83
666600040008	600	31.932,03
666700040008	700	55.984,42



SÉCULO XXI - VÁLVULAS DE ACOMETIDA REGISTRO CON UNIONES ROSCADAS

PN10 - PN16

Referencia	Ø x Rh	€/Ud.
666020025002	20 - ¾"	73,11
666025032002	25 - 1"	73,11
666032040002	32 - 1 ¼"	110,19
666040050002	40 - 1 ½"	110,19
666050063002	50 - 2"	136,54

Con eje en acero inoxidable AISI 316 L +10%



SÉCULO XXI - VÁLVULAS DE ACOMETIDA REGISTRO CON UNIONES ROSCADAS

PN10 - PN16

Referencia	Ø x Rh	€/Ud.
666025032003	25/ 1" - 1 ¼"	148,26
666032040003	32/1 ¼" - 2"	174,40
666040050003	40/ 1 ½" - 2"	209,29
666050063003	50/ 2" - 2"	261,61

Con eje en acero inoxidable AISI 316 L +10%



TRAMPILLONES MODELO TELESCÓPICO

Referencia	Modelo	€/Ud.
E139EBAREC	CUADRADO	45,55
E139EBARER	REDONDO	45,55
E139EBAREH	HEXAGONAL	45,55
E737CLEBAC	LLAVE DE CIERRE	86,76

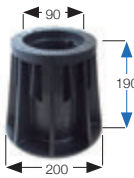

Un solo cuerpo



3 tapas diferentes = Reducción de stocks



TRAMPILLONES COMPOSITE

Referencia	Modelo	€/Ud.
E139EBA4ER	REDONDO	24,72
E139EBA4EC	CUADRADO	24,72
E139EBA4EE	HEXAGONAL	24,72
E737CLEBAC	LLAVE DE CIERRE	86,76



CUADRADILLO

Referencia	DN	€/Ud.
666020050027	20-¾"/ 25-1"/32 1¼"/ 40-1 ½"/ 50-2"	15,70
666040050027	40-50	15,70
666060080027	60-65-80	15,70
666100150027	100-125-150	15,70
666200200027	200	19,19
666250300027	250-300	20,94
666350500027	350-400-450-500	40,11
666600600027	600	87,21



VOLANTE

Referencia	DN	€/Ud.
666020050008	20-¾"/ 25-1"/32 1¼"/ 40-1 ½"/ 50-2"	18,56
666040050006	40-50	18,56
666065080006	60-65-80	20,39
666100100006	100	20,39
666125150006	125-150	37,10
666200200006	200	74,22
666250250006	250	103,91
666300300006	300	122,44
666350400006	350-400	148,44
666450500006	450-500	185,54
666600600006	600	259,74



OBTURADOR ANTIRROBO

Referencia	DN	€/Ud.
10720101	20-¼" / 25-1" /32-1 ¼"/ 40-1 ½"/ 50-2"	87,20
	Otros DN	CONSULTAR



LLAVE PARA OBTURADOR ANTIRROBO

Referencia	DN	€/Ud.
10720100	20-¼" / 25-1" /32-1 ¼"/ 40-1 ½"/ 50-2"	558,10
	Otros DN	CONSULTAR



EJE TELESCÓPICO 1 METRO

Referencia	DN	€/Ud.
666020050013	20-25-32-40-50	76,81
666040050013	40 - 50	76,81
666060080013	60-65-80	76,81
666100100013	100	76,81
666125150013	125-150	76,81
666200200013	200	76,81
666250300013	250-300	102,05
666350350013	350	102,05
666400400013	400	143,23
666450500013	450/500	143,62
666350500013	350 HASTA 500	143,62
666600600013	600	150,30



LLAVE DE M

Referencia	€/Ud.
10701005	174,40

JLAS

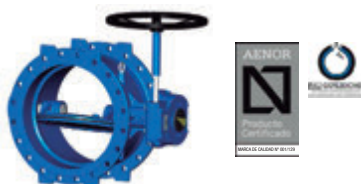

VÁLVULAS DE MARIPOSA MODELO DUPLEX 500

Serie 14 - PN10

Referencia	DN	€/Ud.
66615000012	150	1.719,06
666200010012	200	1.842,18
666250010012	250	2.113,35
666300010012	300	2.434,41
666350010012	350	3.243,29
666400010012	400	3.734,23
666450010012	450	5.353,52
666500010012	500	5.895,90
666600010012	600	7.448,18
666700010012	700	11.071,76
666800010012	800	15.370,18
666900010012	900	22.138,84
666100010012	1000	26.527,64
666110010012	1100	40.080,57

Serie 14 - PN16

Referencia	DN	€/Ud.
66615000012	150	1.719,06
666200016012	200	1.842,18
666250016012	250	2.113,35
666300016012	300	2.434,41
666350016012	350	3.243,29
666400016012	400	3.734,23
666450016012	450	5.353,52
666500016012	500	5.895,90
666600016012	600	8.936,60
666700016012	700	11.343,22
666800016012	800	15.829,94
666900016012	900	22.802,78
666100016012	1000	27.324,04
666110016012	1100	41.283,74

Con eje en acero inoxidable AISI 316 L +10%

Serie 14 - PN25

Referencia	DN	€/Ud.
666150025012	150	2.104,01
666200025012	200	2.253,64
666250025012	250	2.584,01
666300025012	300	2.976,79
666350025012	350	3.966,43
666400025012	400	4.566,48
666450025012	450	6.548,90
666500025012	500	7.211,28
666600025012	600	10.931,50
666700025012	700	18.572,94
666800025012	800	22.561,20
666900025012	900	28.436,84
666100025012	1000	37.170,79
666110025012	1100	CONSULTAR



VÁLVULAS DE COMPUERTA DE CIERRE ELÁSTICO MODELO 3000 PARA GAS

Serie 14 - PN10-16

Referencia	Ø	€/Ud.
666063G10020	63	784,83
666075G10020	75	872,02
666090G10020	90	1.046,44
666110G10020	110	1.220,85
666125G10020	125	1.569,66
666160G10020	160	2.005,68
666200G10020	200	3.488,12
666250G10020	250	4.185,75
666315G10020	315	8.720,31

Con extremos de PE SDR11-SDR17



VÁLVULAS DE RETENCIÓN DE CLAPETA
SERIE 48 - PN 16

Referencia	DN	€/Ud.
666050000028	50	333,98
666060000028	60	417,47
666065000028	65	417,47
666080000028	80	467,57
666100000028	100	567,75
666125000028	125	846,63
666150000028	150	1.252,38
666200000028	200	1.875,25
666250000028	250	3.339,71
666300000028	300	4.174,61
666350000028	350	5.009,54
666400000028	400	7.013,36
666450000028	450	10.019,08
666500000028	500	13.024,81
666600000028	600	18.869,27

Con eje y asiento en acero inoxidable AISI 316 L +30%



VÁLVULAS DE RETENCIÓN DE CLAPETA CON
CONTRAPESO

SERIE 48 - PN 16

Referencia	DN	€/Ud.
666050016028	50	400,76
666060016028	60	500,96
666065016028	65	500,96
666080016028	80	567,75
666100016028	100	667,95
666125016028	125	1.001,90
666150016028	150	1.502,87
666200016028	200	2.254,29
666250016028	250	4.007,65
666300016028	300	5.009,54
666350016028	350	5.844,46
666400016028	400	8.349,24
666450016028	450	11.688,93
666500016028	500	14.193,70
666600016028	600	20.038,18

Con eje en acero inoxidable 316 L +30%

También disponible en color rojo para saneamiento y aguas residuales. **PRECIOS CONSULTAR**



FILTRO
PN16

Referencia	DN	€/Ud.
666040000032	40	228,48
666050000032	50	259,87
666060000032	60	352,30
666065000032	65	352,30
666080000032	80	381,95
666100000032	100	554,61
666125000032	125	683,68
666150000032	150	910,40
666200000032	200	1.519,06
666250000032	250	2.251,59
666300000032	300	3.020,72

También disponible en PN10 y PN25



VÁLVULAS DE RETENCIÓN DE BOLA

PN 16

Referencia	Ø x Rh	€/Ud.
666032001630	32-1 ¼"	121,89
666040001630	40-1 ½"	121,89
666050001630	50-2"	146,95

Disponible también en PN10

También disponible en color rojo para saneamiento y aguas residuales. **PRECIOS CONSULTAR**



VÁLVULAS DE RETENCIÓN DE BOLA

PN 16

Referencia	DN	€/Ud.
666040016031	40	175,34
666050016031	50	175,34
666060016031	60	217,07
666065016031	65	217,07
666080016031	80	258,83
666100016031	100	367,38
666125016031	125	551,05
666150016031	150	684,64
666200016031	200	1.118,81
666250016031	250	2.404,59
666300016031	300	3.306,29
666350016031	350	5.176,54
666400016031	400	8.198,94

Disponible también en PN10

También disponible en color rojo para saneamiento y aguas residuales. **PRECIOS CONSULTAR**

HERRAMIENTA PARA EXTRACCIÓN DE BOLA

Referencia	DN	€/Ud.
10763744	32-1 ¼"	209,29
10763744	40-1 ½"	209,29
10763754	50-2"	209,29
10763744	40	209,29
10763754	50	209,29
10763764	60	348,81
10763764	65	348,81
10763784	80	348,81
10763794	100	401,14
10763804	125	401,14
10763814	150	453,46
10763824	200	540,63
10763834	250	662,74
10763844	300	872,02
10763854	350	1.220,85
10763864	400	1.569,66



BOLA DE RECAMBIO

Referencia	DN	€/Ud.
BOLA DE RECAMBIO DE ALUMINIO	32 / 1¼"	64,52
BOLA DE RECAMBIO DE ALUMINIO	40 / 1½"	64,52
BOLA DE RECAMBIO DE ALUMINIO	50 / 2"	64,52
BOLA DE RECAMBIO DE ALUMINIO	40	64,52
BOLA DE RECAMBIO DE ALUMINIO	50	64,52
BOLA DE RECAMBIO DE ALUMINIO	60	69,78
BOLA DE RECAMBIO DE ALUMINIO	65	69,78
BOLA DE RECAMBIO DE ALUMINIO	80	81,97
BOLA DE RECAMBIO DE ALUMINIO	100	123,84
BOLA DE RECAMBIO DE HIERRO	125	176,15
BOLA DE RECAMBIO DE HIERRO	150	211,03
BOLA DE RECAMBIO DE HIERRO	200	385,42
BOLA DE RECAMBIO DE HIERRO	250	776,11
BOLA DE RECAMBIO DE HIERRO	300	1.130,14
BOLA DE RECAMBIO DE HIERRO	350	1.574,89
BOLA DE RECAMBIO DE HIERRO	400	2.799,23



VENTOSAS AUTOMÁTICAS DE DOBLE EFECTO

PN 16

Referencia	DN	€/Ud.
666040065011	40-50-60-65	315,69
666080002111	80	373,22
666100002111	100	373,22
666025002111	1"	273,81
666032002111	1 ¼"	273,81

Referencia	DN	€/Ud.
666040000111	1 ½"	273,81
666200002111	2"	273,81
666212002111	2 ½"	287,77

Opcional con filtro. Consultar.



VENTOSAS AUTOMÁTICAS DE TRIPLE EFECTO SIN VÁLVULA PARA AGUAS LIMPIAS

PN 10

Referencia	DN	€/Ud.
19908610	50	709,83
19908615	60	709,83
19908620	65	709,83
19908630	80	835,40
19908640	100	835,40
19908650	150	2.139,96
19908660	200	3.430,58

PN 16

Referencia	DN	€/Ud.
19908610	50	709,83
19908615	60	709,83
19908620	65	709,83
19908630	80	835,40
19908640	100	835,40
19908650	150	2.139,96
19908661	200	3.430,58



VENTOSAS AUTOMÁTICAS DE TRIPLE EFECTO CON VÁLVULA PARA AGUAS LIMPIAS

PN 10

Referencia	DN	€/Ud.
666050003005	50	978,43
666060003005	60	978,43
666065003005	65	978,43
666080003005	80	1.194,68
666100003005	100	1.194,68
666150003005	150	2.678,88
666200013005	200	4.328,77

PN 16

Referencia	DN	€/Ud.
666050003005	50	978,43
666060003005	60	978,43
666065003005	65	978,43
666080003005	80	1.194,68
666100003005	100	1.194,68
666150003005	150	2.678,88
666200003005	200	4.328,77

PATROL
X-380



Medida	Ref.	U/	n.º	€
¾" BSP	093108	10	A-10	18,40
1" BSP	093109	10	A-10	18,40

Ventosa doble efecto, cierre a baja presión.

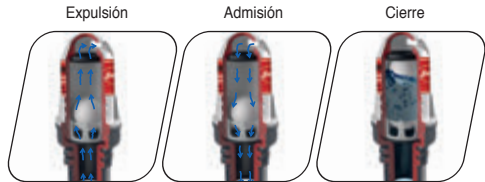

X-380 - Ventosa de Vacío/ Cierre a baja presión.

Expulsión: En el momento de llenado de la red, la ventosa permanece abierta expulsando todo el aire sobrante de la instalación, hasta que la red está llena de agua y la ventosa cierra de manera estanca.

Admisión: Bajo presiones negativas (vacío), la ventosa abre introduciendo aire en la red, evitando de esta forma deterioros en tuberías y accesorios.

Cierre: En el momento en que el agua toma contacto con el flotador, lo empuja hasta su cierre estanco con la junta torica.

X-294



Medida	Ref.	U/	n.º	€
¾" BSP	093067	10	A-10	19,28
1" BSP	093068	10	A-10	19,28
1 ½" BSP	093082	4	A-2	42,29
2" BSP	093083	4	A-2	42,29
1 ½" BSP	193082*	4	A-2	44,41
2" BSP	193083*	4	A-2	44,41

Ventosa doble efecto.

* Con filtro de toma.

X-295



Medida	Ref.	U/	n.º	€
¾" BSP	093071	10	A-10	37,85
1" BSP	093072	10	A-10	37,85
1 ½" BSP	093086	1	A-1	120,49
2" BSP	093087	1	A-1	120,49
1 ½" BSP	193086*	1	A-1	126,70
2" BSP	193087*	1	A-1	126,70

Ventosa triple efecto.

* Con cuna filtro.

Medida	Ref.	U/	n.º	€
1 ½"-2"	093116	10	A-10	6,02

Cuna filtro ventosa.



HIDRANTE DE SUPERFICIE COLUMNA SECA

Referencia	DN	PN	€/Ud.
666045070036	100	2x45-1x70	1.669,84
666070100036	100	2x70-1x100	1.669,84



HIDRANTES DE ACERA

Referencia	DN	Salidas DN	Con Arqueta	€/Ud.
666080070034	80	BARNA 70	SI	630,84
666080070035	80	BARNA 70	NO	474,98
666100100034	100	100	SI	760,71
666100100035	100	100	NO	604,86



BOCA DE RIEGO

Referencia	DN	Salidas DN	€/Ud.
666040065014	40-50-60-65	Rosca 1 1/2" Racord Barcelona	415,61



COLLARÍN DE TOMA PARA PVC Y PE

PN10 - PN16 - PN25

Referencia	Ø x Rh	€/Ud.
666050034004	50 ¾"	29,68
666050100004	50 1"	29,68
666050114004	50 1 ¼"	29,68
666050112004	50 1 ½"	29,68
666063034004	63 ¾"	32,66
666063100004	63 1"	32,66
666063114004	63 1 ¼"	32,66
666063112004	63 1 ½"	32,66
666063200004	63 2"	32,66
666075034004	75 ¾"	37,10
666075100004	75 1"	37,10
666075114004	75 1 ¼"	37,10
666075112004	75 1 ½"	37,10
666075200004	75 2"	37,10
666090034004	90 ¾"	43,03
666090100004	90 1"	43,03
666090114004	90 1 ¼"	43,03
666090112004	90 1 ½"	43,03
666090200004	90 2"	43,03
666090212004	90 2 ½"	51,96
666110034004	110 ¾"	51,96
666110100004	110 1"	51,96
666110114004	110 1 ¼"	51,96
666110112004	110 1 ½"	51,96
666110200004	110 2"	51,96
666110212004	110 2 ½"	62,35
666110300004	110 3"	66,79
666125034004	125 ¾"	80,16
666125100004	125 1"	80,16
666125114004	125 1 ¼"	80,16
666125112004	125 1 ½"	80,16
666125200004	125 2"	80,16
666125212004	125 2 ½"	96,48
666125300004	125 3"	103,91
666140034004	140 ¾"	80,16
666140100004	140 1"	80,16
666140114004	140 1 ¼"	80,16
666140112004	140 1 ½"	80,16
666140200004	140 2"	80,16
666140212004	140 2 ½"	96,48
666140300004	140 3"	103,91
666160034004	160 ¾"	83,12
666160100004	160 1"	83,12

Referencia	Ø x Rh	€/Ud.
666160114004	160 1 ¼"	83,12
666160112004	160 1 ½"	83,12
666160200004	160 2"	83,12
666160212004	160 2 ½"	97,98
666160300004	160 3"	106,87
666180034004	180 ¾"	118,74
666180100004	180 1"	118,74
666180114004	180 1 ¼"	118,74
666180112004	180 1 ½"	118,74
666180200004	180 2"	118,74
666200034004	200 ¾"	118,74
666200100004	200 1"	118,74
666200114004	200 1 ¼"	118,74
666200112004	200 1 ½"	118,74
666200200004	200 2"	118,74
666200212004	200 2 ½"	148,44
666200300004	200 3"	160,32
666225034004	225 ¾"	148,40
666225100004	225 1"	148,40
666225114004	225 1 ¼"	148,40
666225112004	225 1 ½"	148,40
666225200004	225 2"	148,40
666225212004	225 2 ½"	177,12
666225300004	225 3"	177,12
666250034004	250 ¾"	148,40
666250100004	250 1"	148,40
666250114004	250 1 ¼"	148,40
666250112004	250 1 ½"	148,40
666250200004	250 2"	148,40
666250212004	250 2 ½"	193,05
666250300004	250 3"	193,05
666280034004	280 ¾"	172,32
666280100004	280 1"	172,32
666280114004	280 1 ¼"	172,32
666280112004	280 1 ½"	172,32
666280200004	280 2"	172,32
666280212004	280 2 ½"	204,25
666280300004	280 3"	204,25
666315034004	315 ¾"	177,12
666315100004	315 1"	177,12
666315114004	315 1 ¼"	177,12
666315112004	315 1 ½"	177,12
666315200004	315 2"	177,12
666315212004	315 2 ½"	177,12
666315300004	315 3"	210,62
666400034004	400 ¾"	215,41
666400100004	400 1"	215,41
666400114004	400 1 ¼"	215,41
666400112004	400 1 ½"	215,41
666400200004	400 2"	215,41
666400212004	400 2 ½"	255,31
666400300004	400 3"	274,44



ADAPTADOR DE TOMA EN CARGA

PN 10 - PN 16

Referencia	Rm x Rh	€/Ud.
666212000000	2" 1/2"	174,41
666234000000	2" 3/4"	174,41
666210000000	2" 1"	174,41
666211400000	2" 1 1/4"	174,41
666211200000	2" 1 1/2"	174,41
666220000000	2" 2"	174,41



LAMINA DE CORTE

Referencia	€/Ud.
666LAM000000	87,20



BRIDAS DE UNIÓN DE DOBLE CÁMARA PARA TUBO DE PVC

Referencia	DN/DN Tubo	PN	€/Ud.
666063000000	50-63	10/16	30,07
666050065000	50-60-65/63	10/16	30,07
666065000000	60-65/63	10/16	30,07
666075000000	60-65/75	10/16	31,71
666090000000	80/90	10/16	38,40
666100000000	100/90	10/16	43,42
666110000000	100/110	10/16	43,42
666125000000	125/125	10/16	51,78
666140000000	125/140	10/16	56,76
666160000000	150/160	10/16	78,48
666200000000	200/200	10/16	93,50
666225000000	200/225	10/16	195,39
666250000000	250/250	10/16	175,34
666280000000	250/280	10/16	320,61
666315000000	300/315	10/16	320,61
666400010000	400/400	10	642,89
666400000000	400/400	16	642,89
666500010000	500/500	10	993,56
666500000000	500/500	16	993,56

También disponible en color rojo para saneamiento y aguas residuales. **PRECIOS CONSULTAR**



También disponible en color rojo para saneamiento y aguas residuales. **PRECIOS CONSULTAR**

BRIDAS DE UNIÓN DE DOBLE CÁMARA CON ANILLO AUTOBLOCANTE PARA PVC Y PE

Referencia	DN/DN Tubo	PN	€/Ud.
666063000003	50/63	10/16	50,10
666065000003	60-65/63	10/16	55,10
666075000003	60-65/75	10/16	60,10
666090000003	80/90	10/16	68,47
666100000003	100/90	10/16	75,15
666110000003	100/110	10/16	75,15
666125000003	125/125	10/16	105,20
666140000003	125/140	10/16	110,19
666160000003	150/160	10/16	140,26
666200000003	200/200	10/16	180,35
666225000003	200/225	10/16	467,57
666250000003	250/250	10/16	410,77
666280000003	250/280	10/16	768,15
666315000003	300/315	10/16	572,75
666400010003	400/400	10	1.113,78
666400000003	400/400	16	1.113,78
666500010003	500/500	10	1.709,92
666500000003	500/500	16	1.709,92

Referencia	DN/DN Tubo	PN	€/Ud.
666063025003	50/63	25	61,79
666065025003	60-65/63	25	68,47
666075025003	60-65/75	25	76,81
666090025003	80/90	25	85,16
666100025003	100/90	25	95,17
666110025003	100/110	25	95,17
666125025003	125/125	25	128,57
666140025003	125/140	25	138,58
666160025003	150/160	25	175,34
666200025003	200/200	25	225,43
666225025003	200/225	25	587,79
666250025003	250/250	25	515,99
666280025003	250/280	25	CONSULTAR
666315025003	300/315	25	719,70
666400025003	400/400	25	1.456,11
666500025003	500/500	25	2.222,57



CINTAS DE SEÑALIZACIÓN

Referencia	Descripción	€/m
A=15 cm		A=15 cm
CSA000500015	¡ATENCIÓN! Tubería de Agua Potable	0,25
CSG000500015	Canalización de Gas	0,25
CST000500015	Servicios de Telecomunicaciones	0,25

Accesorios para saneamiento enterrado PVC

INFRAESTRUCTURA

REDI

aliaxis



Color Gris: Ral 7037 • Color Teja: Ral 8023

CON JUNTA



45°

Medida	Ref.	U/	U/Pallet	€
110	SN8 030115E	15	120	15,96
125	080125E	10	80	19,48
160	030165E	4	32	43,41
200	0302051	1	20	104,91
250	0302591	1	12	294,39
315	1303091	1	5	707,07
400	o N304091	1	2	870,47
500	*o N305091	1	1	1.592,89
630	*o N306391	1	1	2.833,85

Derivación 45° macho/hembra, con junta labiada. Color Teja.



45°

Medida	Ref.	U/	U/Pallet	€
110	SN8 0441141	12	96	16,52
125	0441241	8	64	19,61
160	0441641	4	32	51,45
200	1442041	1	20	161,57
250	1442551	1	10	353,26
315	1443041	1	4	810,07

Derivación 45° hembra/hembra, con junta labiada. Color Teja.



45°

Medida	Ref.	U/	U/Pallet	€
125-110	031925E	10	80	14,00
160-110	031165E	7	56	46,14
160-125	031365E	6	48	52,66
200-110	031355E	4	32	96,15
200-125	031375E	4	32	101,88
200-160	031205E	3	24	104,16
250-110	o 0313391	1	20	287,58
250-125	o D313491	1	16	287,58
250-160	o 0314091	1	20	304,72
250-200	o 0314191	1	14	309,42
315-110	o 1318051	1	10	573,66
315-125	o 1318151	1	9	573,66
315-160	o 0314291	1	12	684,10
315-200	o 0314391	1	10	716,04
315-250	o D314491	1	5	797,93
400-110	o 1314451	1	4	878,47
400-125	o 1313351	1	4	878,47
400-160	o 1316651	1	4	958,71
400-200	o 1317751	1	4	982,96
400-250	o D314691	1	3	1.057,71
400-315	o D314791	1	3	1.057,71
500-110	*o 1315051	1	2	899,35
500-125	*o 1315251	1	2	904,73
500-160	*o 1315351	1	2	1.509,36
500-200	*o 1315451	1	2	1.509,36
500-250	*o D314991	1	3	1.743,78
500-315	*o D315091	1	1	1.743,78
500-400	*o D315191	1	1	1.872,26

Derivación 45° macho/hembra, reducida al centro, con junta labiada. Color Teja.



45°

Medida	Ref.	U/	U/Pallet	€
160-110	0311741	6	48	57,42
160-125	+ 0311832	6	48	59,15
200-125	+ 0313832	4	32	107,03
200-160	0312151	1	25	111,42
250-160	1444041	1	16	322,15
250-200	* 1444141	1	12	328,88
315-110	1443451	1	10	573,66
315-125	o+ 1443542	1	10	573,66
315-160	1444241	1	10	573,66
315-200	1444341	1	8	573,66
315-250	* 1444551	1	6	836,39
400-110	*o 1444441	1	5	878,47
400-160	o+ 1446642	1	5	878,47
400-200	*o+ 1447742	1	4	878,47

Derivación 45° hembra/hembra, reducida al centro, con junta labiada. Color Teja.



87°-30'

Medida	Ref.	U/	U/Pallet	€
110	SN8 034115E	20	160	13,55
125	081125E	12	96	16,45
160	081165E	5	40	40,83
200	081205E	1	30	87,57
250	034259I	1	18	243,39
315	134309I	1	8	579,50
400	*o 134405I	1	2	870,47
500	*o N34509I	1	1	1.980,47
630	*o N34639I	1	1	2.964,75

Derivación 87° - 30' macho/hembra, con junta labiada. Color Teja.



87°-30'

Medida	Ref.	U/	U/Pallet	€
125	045124I	10	80	37,17
160	045164I	5	40	42,85
200	145204I	1	28	151,20
250	145254I	1	15	346,70
315	145304I	1	6	675,74
400	o 145405I	1	2	1.169,21

Derivación 87°-30', hembra/hembra, con junta labiada. Color Teja.



87°-30'

Medida	Ref.	U/	U/Pallet	€
160-110	035174I	8	64	52,79
160-125	* 046364I	6	48	52,30
200-110	046015I	1	33	138,25
200-125	* 046024I	1	32	138,25
200-160	046064I	1	30	139,63
250-110	146114I	1	18	262,71
250-125	* 146124I	1	18	287,99
250-160	* 146164I	1	18	323,27
250-200	*+ 146204I	1	15	354,04
315-110	*+ 146414I	1	9	384,84
315-125	* 146434I	1	10	384,84
315-160	146425I	1	10	384,84
315-200	146445I	1	10	392,50
400-110	*o 146554I	1	5	568,65
400-125	o*+ 146334I	1	9	568,65
400-160	*o 146664I	1	5	663,32
400-200	146774I	1	4	637,84
400-250	o*+ 146884I	1	4	722,65
400-315	o*+ 146994I		3	748,98

Derivación 87°-30', hembra/hembra, reducida al centro, con junta labiada. Color Teja.



87°-30'

Medida	Ref.	U/	U/Pallet	€
125-110	035725I	12	96	38,36
160-110	035165E	10	80	47,00
160-125	035365I	1	70	48,96
200-110	035015E	4	32	78,56
200-125	035025E	4	32	67,22
200-160	o 035205E	4	32	72,62
250-110	o 035355I	1	20	139,63
250-125	+ 035344I	1	18	153,03
250-160	o 035405I	1	18	233,13
250-200	o 035385I	1	18	255,28
315-110	o 135225I	1	10	384,84
315-125	o 135335I	1	10	384,84
315-160	o 135445I	1	12	373,70
315-200	o 135555I	1	12	384,84
315-250	o D35469I	1	6	598,20
400-110	*o 135415I	1	5	568,65
400-125	*o+ 135425I	1	5	568,65
400-160	o 135665I	1	4	597,57
400-200	o 135775I	1	4	625,31
400-250	o 135885I	1	4	663,32
400-315	o 135995I	1	4	681,28
500-110	*o 135505I	1	2	907,38
500-125	*o 135525I	1	2	912,78
500-160	*o 135535I	1	4	918,18
500-200	*o 135545I	1	2	1.119,52
500-250	*o D35499I	1	3	1.778,55
500-315	*o D35509I	1	2	2.238,51
500-400	*o D35519I	1	1	2.406,83

Derivación 87°-30', macho/hembra, reducida al centro, con junta labiada. Color Teja.

SN8: Rigidez anular.

o: Producto manipulado.

+ : Color gris.

*: Consultar plazo de entrega.



87°-30°

Medida	Ref.	U/ 	U/Pallet	€
250	1402591	1	16	265,04
315	1403091	1	8	642,61

Te macho/hembra 87°-30° con boca de registro, con junta labiada.
Color Teja.



Medida	Ref.	U/ 	U/Pallet	€
110	061115E	45	360	7,66
125	061125E	30	240	11,16
160	061165E	18	144	24,37
200	061205E	8	64	47,68
250	0612591	1	36	132,62
315	0613091	1	20	212,21
400	0614091	1	12	339,58
500	o 1615051	1	4	738,26
630	o D616391	1	3	2.279,41

Manguito dilatación hembra-hembra, con junta labiada.
Color Teja. SIN tope.



Medida	Ref.	U/ 	U/Pallet	€
110	063115E	45	360	9,60
125	063125E	30	240	12,10
160	063165E	18	144	24,37
200	063205E	8	64	47,68
250	0632591	1	36	132,62
315	0633091	1	20	212,21
400	0634091	1	12	339,58
500	o 1635051	1	4	738,26

Manguito dilatación hembra-hembra, con junta labiada.
Color Teja. CON tope.

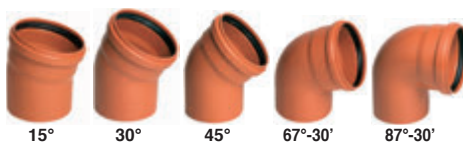

Ángulo - Medida	Ref.	U/ 	U/Pallet	€
15° 110	SN8 010115E	40	320	5,43
15° 125	010125E	25	200	8,46
15° 160	010165E	13	104	19,30
15° 200	010205E	8	64	38,64
15° 250	0102591	1	36	103,71
15° 315	0103091	1	18	163,32
15° 400	1104091	1	10	492,54
15° 500	*o N105091	1	2	841,73
15° 630	*o N106391	1	1	1.595,58
30° 110	SN8 0111151E	40	320	5,02
30° 125	011125E	25	200	9,02
30° 160	011165E	13	104	21,45
30° 200	011205E	1	60	42,85
30° 250	0112591	1	33	114,82
30° 315	0113091	1	18	180,84
30° 400	1114091	1	8	553,22
30° 500	*o N115091	1	2	1.102,61
30° 630	*o N116391	1	1	1.595,58
45° 110	SN8 012115E	35	280	6,97
45° 125	070125E	23	184	8,36
45° 160	070165E	10	80	22,79
45° 200	070205E	5	40	53,22
45° 250	0122591	1	27	141,42
45° 315	0123091	1	14	204,71
45° 400	1124091	1	7	611,93
45° 500	1125091	1	4	914,46
45° 630	*o N126391	1	1	1.595,58
67°-30' 110	SN8 013115E	30	240	6,77
67°-30' 125	013125E	20	160	11,20
67°-30' 160	013165E	10	80	25,86
67°-30' 200	013205E	5	40	56,43
87°-30' 110	SN8 071115E	25	200	8,42
87°-30' 125	071125E	20	160	13,94
87°-30' 160	071165E	10	80	24,95
87°-30' 200	071205E	1	40	56,75
87°-30' 250	0142591	1	20	177,32
87°-30' 315	0143091	1	10	294,98
87°-30' 400	1144091	1	6	817,83
87°-30' 500	*o 1145091	1	2	1.831,01
87°-30' 630	*o N146391	1	1	2.041,96

Codo macho/hembra, con junta labiada. Color Teja



45°

87°-30°

Ángulo - Medida	Ref.	U/	U/Pallet	€
45° 110	023115E	30	240	18,77
45° 125 +	0231242	20	160	21,40
45° 160	0231641	10	80	32,22
45° 200	0232041	5	40	63,84
45° 250	1232541	1	27	190,39
45° 315	1233041	1	12	275,64
45° 400	1234051	1	6	698,52
87°-30° 110	024135E	25	200	19,17
87°-30° 125 +	0241242	18	144	21,40
87°-30° 160	0241651	8	64	35,79
87°-30° 200	0242151	4	32	76,38
87°-30° 250	1242541	1	20	238,71
87°-30° 315	1243041	1	10	397,08
87°-30° 400	1244051	1	5	951,58

Codo hembra/hembra, con junta labiada. Color Teja



Medida H / M	Ref.	U/	U/Pallet	€
A 110-125	051325E	35	280	8,12
A 110-160	051165E	30	240	12,87
B 110-200 o	1533551	15	120	59,50
B 110-250	0534151	10	80	90,96
A 125-160	051365E	30	240	12,87
A 125-200	051205E	15	120	32,18
B 125-250	0534251	10	80	168,22
A 160-200	051405E	15	120	44,51
A 160-250	0514651	1	85	56,13
B 160-315	0534851	5	40	63,32
B 160-400 o	1536051	1	26	61,46
A 200-250	051255E	5	60	74,29
A 200-315	051335E	4	32	103,56
B 200-400 o	1536551	1	26	262,45
A 250-315	0513091	1	32	119,80
B 250-400	1537091	1	24	358,91
A 315-400	0519291	1	18	272,47
C 400-500 o	D519491	1	4	707,25

Ampliación excéntrica hembra-macho, con junta labiada. Color Teja.

H = Hembra - M = Macho.

SN8: Rigidez anular.

* : Consultar plazo de entrega.

o : Producto manipulado.

+ : Color gris.



Medida	Ref.	U/	U/Pallet	€
110	066110E	150	1200	4,21
125	066120E	100	800	5,34
160	066160E	55	440	11,82
200	066200E	25	200	19,45
250	0662501	1	114	61,78
315	0663001	1	67	115,11
400	06640M1	1	50	175,59
500	D665001	1	18	597,70

Tapón macho ciego para encolar. Color Teja.



Medida	Ref.	U/	U/Pallet	€
110	0651101	70	560	8,97
125	0651201	50	400	11,23
160	1651601	30	240	19,13
200	1652001	15	120	32,18
250	1652501	10	100	83,37
315	1653001	5	50	122,46

Tapón macho con registro, para encolar. Color Teja.



Medida	Ref.	U/	U/Pallet	€
110	06613F1	30	1560	2,63
125	06615F1	20	1040	2,82
160	06617F1	30	720	9,72
200	06621F1	60	480	12,60
250	06628F1	30	240	27,40
315	06634F1	15	120	45,67
400	06640F1	1	50	140,53

Tapón hembra para encolar. Color Teja.



S-197

Medida	Ref.	U/	n.°	€
250	027004	12	A-61	39,79
315	027028	4	A-4	72,38

Tapón base, para encolar. Color Teja.



90°

Medida	Ref.	U/ 	U/Pallet	€
200-160	0434351	10	80	35,34
250-160	1424251	8	64	46,04
315-160	142525E	8	64	81,85
315-200	+ 1425552	1	26	126,15

Toma injerto 90°, con junta labiada. Color Teja.



45°

Medida	Ref.	U/ 	U/Pallet	€
160-125	0438091	15	120	29,46
200-125	0438291	10	80	32,95
200-160	0438491	10	60	42,55
250-125	0438691	10	70	43,58
250-160	0438891	6	48	56,67
315-125	1439091	5	40	69,50
315-160	0439491	5	30	84,21
315-200	1433291	1	20	81,76
400-125	1439191	5	40	83,66
400-160	1439591	3	24	96,82
400-200	D434291	1	1	94,00
500-125	1439291	5	100	94,74
500-160	1439691	3	24	136,69

Toma injerto 45°, con junta labiada. Color Teja.



Medida	Ref.	U/ 	U/Pallet	€
136-110	0621191	30	240	26,49
160-125	0621291	18	144	39,94
190-160	0621691	10	80	63,05
242-200	0622091	1	60	144,75

Enlace mixto gres-PVC. Color Teja (unión a PVC, Macho Encolar).



Medida	Ref.	U/ 	U/Pallet	€
110	0641191	10	520	19,19
125	0641291	18	432	20,70
160	0641642	12	168	36,60
200	0642042	12	96	70,72

Manguito pasamuros. Superficie granulada, para mejor agarrar al cemento.

Tubería de PVC-U presión

**Tubería
PVC-U**

INDUSTRIA



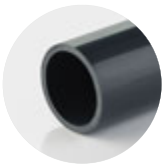

INDUSTRIA

Tubería de PVC-U presión

Tubería de PVC-U presión



UNI EN 1452-2
PN 6 - 10 - 12,5 - 16 - 20
ø 16 + 500 mm



NF EN 1452
PN 6 - 10 - 16 - 25
ø 16 + 315 mm



DN-8061 - 62
Rohr 4, Rohr 5
PN 10 - 16



CARACTERÍSTICAS PRINCIPALES DE LAS TUBERÍAS DE PVC-U

Gama

PN 6 : desde d.63 hasta d400 mm

PN 10 : desde d 63 hasta d 315 mm

Pn16 : desde d 20 hasta d.225 mm

La tubería cumple con la norma EN ISO 1452 para el transporte de fluidos bajo presión (agua potable, riego y aguas residuales). Tiene la marca de calidad IIP conforme a D.M. 174 DD. (agua para consumo humano), y según norma EN 1622, análisis de agua, determinación del umbral de olor (TON) y sabor (TFN).

Requisitos higiénicos

Los tubos Lareter U-PVC para conductos de presión cumplen requisitos higiénicos según el "Ministerio de Salud italiano" D.M.21.03.1973 y D.M. 174/2004.

Francia: certificación A.C.S. (Atestación de Conformité Sanitaire)

Gran Bretaña: aprobado por WRAS (Water Regulations Advisory Scheme) producto.

Alemania: potabilidad publicada por Hygiene-Institut en nombre de DVGW

PN6

Ø	Ref.	Espesor	Longitud (m)	Tubos/pallet	m (pallet completo)	€
63	PIPEV33063	2	5	123	615	6,69
75	PIPEV33075	2,2	5	87	435	9,28
90	PIPEV33090	2,8	5	96	480	12,88
110	PIPEV41110	2,7	5	57	285	15,32
125	PIPEV41125	3,1	5	51	255	20,07
140	PIPEV41140	3,5	5	45	225	25,11
160	PIPEV41160	4	5	33	165	32,52
200	PIPEV41200	4,9	5	20	100	49,86
225	PIPEV41225	5,5	5	18	90	63,03
250	PIPEV41250	6,2	5	12	60	79,06
280	PIPEV41280	6,9	5	11	55	98,20
315	PIPEV41315	7,7	5	9	45	123,59
400	PIPEV41400	9,8	5	5	25	207,82

PN10

63	PIPEV21063	3	5	123	615	9,08
75	PIPEV21075	3,6	5	87	435	12,72
90	PIPEV21090	4,3	5	96	480	18,28
110	PIPEV26110	4,2	5	57	285	22,09
125	PIPEV26125	4,8	5	51	255	28,43
140	PIPEV26140	5,4	5	45	225	36,36
160	PIPEV26160	6,2	5	33	165	47,29
180	PIPEV26180	6,9	5	28	140	63,21
200	PIPEV26200	7,7	5	20	100	73,44
225	PIPEV26225	8,6	5	18	90	92,23
250	PIPEV26250	9,6	5	12	60	114,21
280	PIPEV26280	10,7	5	11	55	142,21
315	PIPEV26315	12,1	5	9	45	181,49

PN16

20	PIPEV13020	1,5	5	1166	5830	2,37
25	PIPEV13025	1,9	5	757	3785	3,67
32	PIPEV13032	2,4	5	449	2245	4,17
40	PIPEV13040	3	5	275	1375	5,49
50	PIPEV13050	3,7	5	194	970	8,47
63	PIPEV13063	4,7	5	123	615	13,47
75	PIPEV13075	5,6	5	87	435	19,06
90	PIPEV13090	6,7	5	96	480	27,32
110	PIPEV17110	6,6	5	57	285	33,53
125	PIPEV17125	7,4	5	51	255	42,74
140	PIPEV17140	8,3	5	45	225	54,22
160	PIPEV17160	9,5	5	33	165	70,71
180	PIPEV17180	10,7	5	28	140	89,39
200	PIPEV17200	11,9	5	20	100	110,27
225	PIPEV17225	13,4	5	20	100	139,79

Tubería PVC-U extremo plano.

Accesorios encolados, mixtos y roscados

Bridas y adaptadores

Uniones 3 piezas

Soportes y abrazaderas

Adhesivos y disolventes

Accesorios de PVC-U presión

INDUSTRIA



Roscas

Perfectas, bien inyectadas y con exactitud milimétrica, ayudan a una perfecta unión suave y fiable con profesionalidad y calidad.



Nervios de tope

Permiten que el tubo sólo penetre hasta el tope.
El pegamento sobrante en su interior se escurre por dentro de la pieza sin cerrar el diámetro interior.

Lineas cada 45°

Ayudan en el montaje para encarar perfectamente los codos y las tes. Con ellas podemos hacer premontajes exactos fuera del lugar donde finalmente se va a colocar, cuando el acceso es complicado.



Packs

Material embolsado hasta diámetro 63 mm. Permite tener las piezas limpias y ordenadas en todo momento. Facilita el contar los stocks así como los inventarios.



Bocas achaflanadas

Ayudan que el tubo entre más fácilmente.
El pegamento sobrante se queda depositado en la zona, cerrando y sellando la unión aún con poco pegamento.



INDUSTRIA

Accesorios de PVC-U presión

Codos

**GIV**

A-B

d	Ref.	PN	Pack	U/	€
12	GIV012	16	10	1.000	1,74
16	GIV016	16	10	500	0,90
20	GIV020	16	10	260	0,90
25	GIV025	16	10	150	1,10
32	GIV032	16	10	120	1,67
40	GIV040	16	10	80	2,36
50	GIV050	16	-	60	3,49
63	GIV063	16	-	50	5,26
75	GIV075	16	-	16	9,83
90	GIV090	16	-	20	16,57
110	GIV110	16	-	10	30,84
125	GIV125	16	-	6	44,38
140	GIV140	16	-	5	75,97
160	GIV160	16	-	4	88,59
180*A)	GIV180	10	-	4	130,48
200*A)	GIV200	10	-	2	138,92
225*A)	GIV225	10	-	2	202,16
250	GIV250	10	-	1	484,73
280	GIV280	10	-	1	902,83
315	GIV315	10	-	1	848,25
400*	GIV400	5	-	1	1.746,61
500*	SIV500	Sólo se fabrica en curva			

Codo 90° encolar.
H-H encolar.

A) Factor de seguridad reducido

**GIMV**

A

d x Rh	Ref.	PN	Pack	U/	€
16 x 3/8"	GIMV016038	16	10	500	3,40
20 x 1/2"	GIMV020012	16	10	260	3,67
25 x 3/4"	GIMV025034	16	10	150	4,33
32 x 1"	GIMV032100	16	10	80	5,52
40 x 1 1/4"	GIMV040114	16	10	40	7,07
50 x 1 1/2"	GIMV050112	16	10	30	10,13
63 x 2"	GIMV063200	16	5	45	13,38

Codo 90° mixto reforzado inox.
H-H encolar-roscar.**GFV**

A

d x Rh	Ref.	PN	Pack	U/	€
16 x 3/8"	GFV038	16	10	400	2,12
1/2"	GFV012	16	10	260	2,12
3/4"	GFV034	16	10	150	2,52
1"	GFV100	16	10	150	3,38
1 1/4"	GFV114	16	10	40	4,84
1 1/2"	GFV112	16	10	40	6,82
2"	GFV200	16	-	50	9,46
2 1/2"	GFV212	16	-	16	25,71
3"	GFV300	16	-	9	38,10
4"	GFV400	16	-	10	62,58

Codo 90° roscado.
H-H roscar.**GIFV**

















A

d x Rh	Ref.	PN	Pack	U/	€
16 x 3/8"	GIFV016038	16	10	400	1,79
20 x 1/2"	GIFV020012	16	10	260	1,84
25 x 3/4"	GIFV025034	16	10	150	2,11
32 x 1"	GIFV032100	16	10	120	2,84
40 x 1 1/4"	GIFV040114	16	10	40	3,72
50 x 1 1/2"	GIFV050112	16	10	40	5,51
63 x 2"	GIFV063200	16	-	50	7,79
75 x 2 1/2"	GIFV075212	16	-	16	24,05
90 x 3"	GIFV090300	16	-	9	36,10
110 x 4"	GIFV110400	16	-	10	55,58

Codo 90° mixto.
H-H encolar-roscar.



**HIV**

A-B

d	Ref.	PN	Pack	U/ 	€
12	HIV012	16	10	800	2,95
16	HIV016 	16	250	1.000	1,21
20	HIV020 	16	10	360	1,21
25	HIV025 	16	10	200	1,57
32	HIV032 	16	10	100	2,11
40	HIV040 	16	10	50	2,84
50	HIV050 	16	-	40	3,82
63	HIV063 	16	-	30	5,52
75	HIV075 	16	-	12	10,93
90	HIV090 	16	-	6	16,22
110	HIV110 	16	-	6	27,36
125	HIV125 	16	-	10	39,81
140	HIV140 	16	-	6	64,11
160	HIV160 	16	-	4	78,35
180*	HIV180	10	-	1	244,95
200	HIV200 	10	-	2	116,04
225	HIV225	10	-	2	228,80
250	HIV250 	10	-	1	396,70
280	HIV280	10	-	1	787,91
315	HIV315 	10	-	1	748,68
400*	HIV400	5	-	1	1.466,37











Codo 45° encolar.
H-H encolar.**HFV**

A

d x Rh	Ref.	PN	Pack	U/ 	€
½"	HFV012	16	10	300	2,57
¾"	HFV034	16	10	200	3,00
1"	HFV100	16	10	120	3,90
1¼"	HFV114 	16	5	60	4,94
1½"	HFV112	16	5	30	7,53
2"	HFV200	16	-	30	10,69
2½"	HFV212	16	-	12	38,63
3"	HFV300	16	-	6	51,09

Codo 45° roscado.
H-H roscar.**SIV**

A-B

d	Ref.	PN	Pack	U/ 	€
20	SIV020 	16	5	140	2,93
25	SIV025 	16	5	80	3,64
32	SIV032 	16	5	45	5,21
40	SIV040 	16	-	20	6,88
50	SIV050 	16	-	40	10,43
63	SIV063 	16	-	24	16,79
75	SIV075 	16	-	15	29,97
90	SIV090 	16	-	8	66,64
110	SIV110 	16	-	5	118,70
160 A)	SIV160 	16	-	4	284,13
180*	SIV180	4	-	1	591,23
200*	SIV200	4	-	1	619,65
225*A)	SIV225	4	-	1	679,21
250*	SIV250	4	-	1	725,44
280*	SIV280	4	-	1	972,33
315*	SIV315	4	-	1	1.497,08
355*	SIV355	4	-	1	1.809,87
400*	SIV400	4	-	1	2.036,47
500*	SIV500	4	-	1	7.146,91

Curva a 90° encolar.
H-H encolar. R=2d

A) Factor de seguridad reducido

**SIHV***

B

d	Ref.	PN	U/ 	€
315	SIHV315	4	1	1.076,05
355	SIHV355	4	1	1.365,89
400	SIHV400	4	1	1.652,89
500	SIHV500	4	1	5.204,56

Curva a 45° encolar.
H-H encolar.

**XIV**

A

d	Ref.	PN	Pack	U/📦	€
25	XIV025 ●	16	10	80	2,99
32	XIV032 ●	16	10	50	4,33
40	XIV040 ●	16	10	40	7,07
50	XIV050 ●	16	10	20	9,55
63	XIV063 ●	16	-	12	13,55

Cruz 90° encolar.
H-H-H-H encolar.

**YIV**

A

d	Ref.	PN	U/📦	€
20	YIV020 ●	16	200	5,26
25	YIV025 ●	16	100	6,10
32	YIV032 ●	16	60	6,85
40	YIV040 ●	16	50	9,31
50	YIV050 ●	16	20	9,74
63	YIV063 ●	16	15	13,93
75*	YIV075 ●	10	12	64,05
90*	YIV090 ●	10	12	95,85
110*	YIV110 ●	10	8	196,32
160*	YIV160 ●	4	1	306,74

Te a 45° encolar.
H-H-H encolar.

**TIV**

A-B

d	Ref.	PN	Pack	U/📦	€
12	TIV012 ●	16	10	500	2,08
16	TIV016 ●	16	10	300	1,09
20	TIV020 ●	16	10	200	1,09
25	TIV025 ●	16	10	100	1,43
32	TIV032 ●	16	10	100	2,04
40	TIV040 ●	16	10	60	3,35
50	TIV050 ●	16	5	60	4,78
63	TIV063 ●	16	-	30	6,84
75	TIV075 ●	16	-	22	14,28
90	TIV090 ●	16	-	12	26,27
110	TIV110 ●	16	-	8	38,42
125	TIV125 ●	16	-	6	62,95
140	TIV140 ●	16	-	6	95,64
160	TIV160 ●	16	-	5	112,97
180*	TIV180 ●	10	-	3	156,53
200 A)	TIV200 ●	10	-	2	181,06
225 A)	TIV225 ●	10	-	1	251,51
250	TIV250 ●	10	-	1	555,40
280	TIV280 ●	10	-	1	1.112,76
315	TIV315 ●	10	-	1	1.002,56
400*	TIV400 ●	4	-	1	2.481,88
500*	TIV500 ●	4	-	1	7.545,44

Te a 90° encolar.
H-H-H encolar.

**TIFV**

A

d x Rh	Ref.	PN	Pack	U/📦	€
16 x 3/8"	TIFV016038 ●	16	10	300	2,17
20 x 1/2"	TIFV020012 ●	16	10	180	2,32
25 x 3/4"	TIFV025034 ●	16	10	100	2,64
32 x 1/2"	TIFV032012 ●	16	10	100	3,38
32 x 1"	TIFV032100 ●	16	10	80	3,33
40 x 1 1/4"	TIFV040114 ●	16	10	60	5,43
50 x 1/2"	TIFV050012 ●	16	5	40	7,73
50 x 1 1/2"	TIFV050112 ●	16	5	60	7,43
63 x 1/2"	TIFV063012 ●	16	-	45	12,06
63 x 2"	TIFV063200 ●	16	-	35	12,10
75 x 2 1/2"	TIFV075212 ●	16	-	12	27,73
90 x 3"	TIFV090300 ●	16	-	12	41,60
110 x 4"	TIFV110400 ●	16	-	8	68,84

Te a 90° mixta.
H-H-H encolar-rosocar.

**TIMV**

A

d x Rh	Ref.	PN	Pack	U/	€
16 x 3/8"	TIMV016038	16	10	180	3,76
20 x 1/2"	TIMV020012	16	10	180	4,19
25 x 3/4"	TIMV025034	16	10	100	4,85
32 x 1"	TIMV032100	16	10	60	6,03
40 x 1 1/4"	TIMV040114	16	10	30	8,65
50 x 1 1/2"	TIMV050112	16	5	20	12,04
63 x 2"	TIMV063200	16	-	10	17,50

Te a 90° mixta reforzada inox.

H-H-H encolar-rosocar.

**TFV**

A

Rh	Ref.	PN	Pack	U/	€
3/8"	TFV038	16	10	300	2,81
1/2"	TFV012	16	10	180	3,33
3/4"	TFV034	16	10	90	3,64
1"	TFV100	16	10	80	4,48
1 1/4"	TFV114	16	10	60	7,07
1 1/2"	TFV112	16	5	60	9,87
2"	TFV200	16	-	30	15,76
2 1/2"	TFV212	16	-	12	32,00
3"	TFV300	16	-	12	42,40
4"	TFV400	16	-	8	77,62

Te a 90° roscada.

H-H-H rosocar.

**TRIV**

A-B

d x Rh	Ref.	PN	Pack	U/	€
25 x 20	TRIV025020	16	10	120	1,78
32 x 20	TRIV032020	16	10	100	2,44
32 x 25	TRIV032025	16	10	90	2,44
40 x 20	TRIV040020	16	10	60	4,19
40 x 25	TRIV040025	16	10	60	4,19
40 x 32	TRIV040032	16	10	60	4,19
50 x 20	TRIV050020	16	5	40	5,46
50 x 25	TRIV050025	16	5	70	5,46
50 x 32	TRIV050032	16	5	60	5,46
50 x 40	TRIV050040	16	5	30	5,46
63 x 25	TRIV063025	16	-	45	9,10
63 x 32	TRIV063032	16	-	45	9,10
63 x 40	TRIV063040	16	-	45	9,10
63 x 50	TRIV063050	16	-	40	9,10
75 x 32	TRIV075032	16	-	18	15,43
75 x 40	TRIV075040	16	-	16	15,43
75 x 50	TRIV075050	16	-	13	15,43
75 x 63	TRIV075063	16	-	12	15,43
90 x 40	TRIV090040	16	-	15	27,30
90 x 50	TRIV090050	16	-	15	27,30
90 x 63	TRIV090063	16	-	12	27,30
90 x 75	TRIV090075	16	-	12	27,30

Te a 90° reducida encolar.

H-H-H encolar.

d x Rh	Ref.	PN	Pack	U/	€
110 x 50	TRIV110050	16	-	10	39,10
110 x 63	TRIV110063	16	-	8	39,10
110 x 75	TRIV110075	16	-	8	39,10
110 x 90	TRIV110090	16	-	8	39,10
125 x 50*	TRIV125050	16	-	1	131,81
125 x 63*	TRIV125063	16	-	1	131,81
125 x 75*	TRIV125075	16	-	1	131,81
125 x 90*	TRIV125090	16	-	1	131,81
125 x 110*	TRIV125110	16	-	1	131,81
160 x 110	TRIV160110	16	-	3	115,25
200 x 90*	TRIV200090	10	-	1	379,42
200 x 110*	TRIV200110	10	-	1	379,42
200 x 160*	TRIV200160	10	-	1	379,42
250 x 110*	TRIV250110	10	-	1	628,17
250 x 160*	TRIV250160	10	-	1	628,17
250 x 200*	TRIV250200	10	-	1	628,17
280 x 225*	TRIV280225	10	-	1	951,99
315 x 200*	TRIV315200	8	-	1	1.167,92
315 x 250*	TRIV315250	8	-	1	1.167,92
400 x 110*	TRIV400110	5	-	1	1.678,82
400 x 315*	TRIV400315	4	-	1	2.481,88
400 x 355*	TRIV400355	4	-	1	2.481,88



MIV

A-B

d	Ref.	PN	Pack	U/	€
12	MIV012	16	10	1.000	1,73
16	MIV016	16	10	600	1,03
20	MIV020	16	10	360	1,02
25	MIV025	16	10	270	1,21
32	MIV032	16	10	150	1,43
40	MIV040	16	10	80	2,12
50	MIV050	16	10	40	2,75
63	MIV063	16	-	40	4,04
75	MIV075	16	-	24	8,33
90	MIV090	16	-	28	10,74
110	MIV110	16	-	24	17,80
125	MIV125	16	-	14	27,36
140	MIV140	16	-	8	40,50
160	MIV160	16	-	6	54,80
180*	MIV180	4	-	1	178,82
200 A)	MIV200	16	-	6	81,97
225 A)	MIV225	16	-	2	133,85
250	MIV250	10	-	2	272,66
280	MIV280	10	-	2	442,07
315	MIV315	10	-	1	382,28
355*	MIV355	5	-	1	589,90
400*	MIV400	5	-	1	655,85
500*	MIV500	4	-	1	829,57

Manguito encolar.
H-H encolar.

A) Factor de seguridad reducido



MIFV

A

d x Rh	Ref.	PN	Pack	U/	€
16 x 3/8"	MIFV016038	16	10	600	1,85
20 x 1/2"	MIFV020012	16	10	300	1,85
25 x 3/4"	MIFV025034	16	10	200	2,11
32 x 1"	MIFV032100	16	10	100	2,34
40 x 1 1/4"	MIFV040114	16	10	80	3,08
50 x 1 1/2"	MIFV050112	16	10	50	4,00
63 x 2"	MIFV063200	16	-	25	5,69
75 x 2 1/2"	1RMA375H00	16	-	75	24,02
90 x 3"	1RMA390I00	16	-	40	26,54
110 x 4"	1RMA311L00	16	-	25	37,91

Manguito mixto.
H-H encolar-roscar.

MFV

A

Rh	Ref.	PN	Pack	U/	€
3/8"	MFV038	16	10	600	2,19
1/2"	MFV012	16	10	300	2,17
3/4"	MFV034	16	10	240	2,53
1"	MFV100	16	10	100	3,07
1 1/4"	MFV114	16	10	80	4,00
1 1/2"	MFV112	16	10	40	5,43
2"	MFV200	16	-	25	7,24
2 1/2"	MFV212	16	-	20	17,51
3"	MFV300	16	-	8	24,64
4"	MFV400	16	-	10	38,31

Manguito roscado.
H-H roscar.

MIMV

A

d x Rh	Ref.	PN	Pack	U/	€
16 x 3/8"	MIMV016038	16	10	600	3,05
20 x 1/2"	MIMV020012	16	10	400	3,31
25 x 3/4"	MIMV025034	16	10	240	3,78
32 x 1"	MIMV032100	16	10	120	4,41
40 x 1 1/4"	MIMV040114	16	10	80	5,59
50 x 1 1/2"	MIMV050112	16	10	40	7,29
63 x 2"	MIMV063200	16	5	25	9,67

Manguito mixto reforzado inox.
H-H encolar-roscar.

DIMV

A

dm x dh x Rh	Ref.	PN	Pack	U/	€
20 x 16 x 3/8"	DIMV20016038	16	10	500	5,16
20 x 16 x 1/2"	DIMV20016012	16	10	250	6,84
25 x 20 x 1/2"	DIMV25020012	16	10	300	6,84
25 x 20 x 3/4"	DIMV25020034	16	10	100	8,10
32 x 25 x 3/4"	DIMV32025034	16	10	160	8,16
32 x 25 x 1"	DIMV32025100	16	10	120	8,59
40 x 32 x 1"	DIMV40032100	16	10	100	8,64
40 x 32 x 1 1/4"	DIMV40032114	16	10	40	15,28
50 x 40 x 1 1/4"	DIMV50040114	16	10	40	15,28
50 x 40 x 1 1/2"	DIMV50040112	16	5	30	17,27
63 x 50 x 1 1/2"	DIMV63050112	16	5	30	17,27
63 x 50 x 2"	DIMV63050200	16	5	30	23,45
75 x 63 x 2"	DIMV75063200	16	-	45	23,45

Doble adaptador mixto M/H-H
reforzado inox.
M-H encolar - H roscar.dm = diám.machos
dh = diám.hembra
Rh = diám.hembra

**DIFV**

A

dm x dh x Rh	Ref.	PN	Pack	U/ 	€
20 x 16 x 3/8"	DIFV20016038	16	10	500	1,97
20 x 16 x 1/2"	DIFV20016012	16	10	400	1,97
25 x 20 x 1/2"	DIFV25020012	16	10	300	2,32
25 x 20 x 3/4"	DIFV25020034	16	10	200	2,32
32 x 25 x 3/4"	DIFV32025034	16	10	130	3,10
32 x 25 x 1"	DIFV32025100	16	10	120	3,10
40 x 32 x 1"	DIFV40032100	16	10	100	4,00
40 x 32 x 1 1/4"	DIFV40032114	16	10	80	4,00
50 x 40 x 1 1/4"	DIFV50040114	16	10	60	5,65
50 x 40 x 1 1/2"	DIFV50040112	16	10	40	5,65
63 x 50 x 1 1/2"	DIFV63050112	16	-	30	8,52
63 x 50 x 2"	DIFV63050200	16	-	24	8,52
75 x 63 x 2"	DIFV75063200	16	-	45	11,93
75 x 63 x 2 1/2"	DIFV75063212	16	-	24	11,93
90 x 75 x 2 1/2"	DIFV90075212	16	-	20	21,15
90 x 75 x 3"	DIFV90075300	16	-	8	21,15
110 x 90 x 3"	DIFV11090300	16	-	6	28,91
110 x 90 x 4"	DIFV11090400	16	-	5	28,91
125 x 110 x 4"	DIFV12110400	16	-	6	53,79

Doble adaptador mixto M/H-H

dm = diám.macho

dh = diám.hembra

Rh = diám.hembra

M-H encolar - H roscar.

QPV PLANO**QRV ESTRIADO**

A-B

d	Ref.	PN	Pack	U/ 	€
20 +	QPV020	16	10	500	1,93
25 +	QPV025	16	10	340	2,28
32 +	QPV032	16	10	200	2,47
40	QPV040	16	10	110	3,18
50	QPV050	16	10	80	3,94
63	QPV063	16	-	48	4,84
75	QPV075	16	-	20	6,65
90	QPV090	16	-	48	9,99
110	QPV110	16	-	32	12,52
125	QPV125	16	-	7	16,48
140	QPV140	16	-	8	22,05
160	QPV160	16	-	10	30,41
180*	QPV180	16	-	1	117,06
200 A)	QPV200	16	-	6	55,63
225 -- A)	QRV225	16	-	6	66,18
250 -- A)	QRV250	16	-	6	148,58
280* --	QRV280	10	-	4	246,48
315 --	QRV315	10	-	3	230,83
355*+	QPV355	5	-	1	403,76
400*	QRV400	5	-	1	484,58
500*+	QPV500	4	-	1	600,20

Manguito portabridas encolar.

+Sólo QPV -- Sólo QRV

H encolar (junta no incluida).

A) Factor de seguridad reducido.

Código portabridas plano, para estriado cambiar QPV por QRV

**FDV**

A

d	Ref.	DN	T PN	U/	€
25	FDV025	20	10	80	8,64
32	FDV032	25	10	48	10,37
40	FDV040	32	10	24	13,54
50	FDV050	40	10	20	15,87
63	FDV063	50	10	14	19,73
75	FDV075	65	10	12	20,73
90	FDV090	75	10	12	23,99
110	FDV110	90	10	6	29,32

Brida con manguito encolar.
H encolar (junta no incluida).

T = Taladros

**QPV FK/FE**

A

d	Ref.	DN	PN	€
125 (2)	QPV125FKE	125	16	68,54
200 (3)	QPV200FKE	200	16	172,34

Portabridas especial para válvula de mariposa FE/FK. Para rebajar el diámetro.

(2) Convierte la válvula de mariposa de 140 en 125. Usar con brida ODV 140 PVC-U.

(3) Convierte la válvula de mariposa de 225 en 200. Usar con brida ODV 225 PVC-U.

**ODB**

T1

d	Ref.	DN	€
20	ODB020	15	9,84
25	ODB025	20	10,82
32	ODB032	25	13,95
40	ODB040	32	16,91
50	ODB050	40	19,77
63	ODB063	50	24,58
75	ODB075	65	27,17
90	ODB090	80	32,36
125*	ODB125	100	39,05
140	ODBD140DN125	125	61,33
180**	ODB180	150	59,47
200	ODB200	200	89,33
225	ODBD225DN200	200	126,01
280	ODBD280DN250	250	130,46
315	ODBD315DN300	300	191,05

Brida loca PP negro con alma de acero.
EN/ISO/DIN - PN 10 / 16 hasta PN 150 - PN 10 DN 200
* Para QPV 110, QRV 110. ** Para QPV 160, QRV 160.

**ODV**

A-B

d	Ref.	T PN	Pack	U/	€
20	ODV020	10	-	250	4,99
25	ODV025	10	-	200	5,72
32	ODV032	10	-	120	6,37
40	ODV040	10	-	60	7,39
50	ODV050	10	-	65	8,32
63	ODV063	10	2	30	9,14
75	ODV075	10	2	16	11,82
90	ODV090	10	2	24	12,61
110	ODV110	10	2	20	17,14
125	ODV125	10	-	16	24,62
140	ODV140	10	-	16	27,99
160	ODV160	10	-	18	33,84
180*	ODV180	10	-	-	108,18
200	ODV200	10	-	9	40,84
225	ODV225	10	-	10	46,47
250	ODV250	10	-	11	132,71
280	ODV280	10	-	12	193,80
315	ODV315	10	-	8	202,02
355*	ODV355	4	-	1	325,22
400*	ODV400	4	-	1	350,01
500*	ODV500	6	-	1	524,73
500*	ODV510	10	-	1	579,40

Brida loca PVC-U para manguito portabridas. T = Taladros



FCV

A-B

d	Ref.	T	PN	Pack	U/ 	€
25	FCV025	10	2	40	8,24	
32	FCV032	10	2	60	10,98	
40	FCV040	10	2	50	14,33	
50	FCV050	10	-	30	17,52	
63	FCV063	10	-	30	21,54	
75	FCV075	10	2	26	28,30	
90	FCV090	10	2	24	32,61	
110	FCV110	10	2	18	42,89	
140*	FCV140	10	-	1	92,35	
160*	FCV160	10	-	1	134,92	
180*	FCV180	10	-	1	172,27	
200*	FCV200	10	-	1	170,44	
225*	FCV225	10	-	1	170,44	
250*	FCV250	8	-	1	347,21	
280*	FCV280	8	-	1	347,21	
315*	FCV315	6	-	1	691,43	

Brida Ciega.

T = Taladros



LIFV

A

d x Rm x Rh	Ref.	PN	Junta	Pack	U/ 	€
16 x 3/4" x 3/8"	1RAS316B00	16	EPDM	5	125	30,29
20 x 1" x 3/4"	1RAS320C00	16	EPDM	5	125	38,15
25 x 1 1/4" x 1"	1RAS325D00	16	EPDM	5	90	43,55
32 x 1 1/2" x 1"	1RAS332D00	16	EPDM	-	60	54,29
40 x 2" x 1 1/2"	1RAS340F00	16	EPDM	-	35	81,72
16 x 3/4" x 1/2"	1RAS316B10	16	FKM	5	125	33,82
20 x 1" x 3/4"	1RAS320C10	16	FKM	5	125	44,62
25 x 1 1/4" x 1"	1RAS325D10	16	FKM	5	90	50,49
32 x 1 1/2" x 1"	1RAS332D10	16	FKM	-	60	68,17
40 x 2" x 1 1/2"	1RAS340F10	16	FKM	-	35	96,98

Adaptador depósito.

H encolar - M-H roscar. Junta plana iuncluida.



LIV

A

d x Rm	Ref.	PN	Pack	U/ 	€ EPDM
25 x 1"	LIV025100	16	10	100	18,15
32 x 1 1/4"	LIV032114	16	10	40	21,16

Adaptador depósito.

M-M encolar - roscar. Junta plana incluida.



LIFV-J

A

A

d x Rm x Rh	Ref.	€ EPDM	€ FKM
16 x 3/4" x 1/2"	GP0195E	2,17	8,46
20 x 1" x 3/4"	GP2299E	4,08	23,64
25 x 1 1/4" x 1"	GP0200E	4,73	25,35
32 x 1 1/2" x 1"	GP0201E	6,00	36,50
40 x 2" x 1 1/2"	GP0202E	8,53	59,45

Junta plana para adaptador depósito.

Código en FKM termina en "F"
en lugar de "E"

LIV-J

A

d x Rm	Ref.	€ EPDM
25 x 1"	GP1205E	1,24
32 x 1 1/4"	GP1206E	1,73

Junta plana para adaptador depósito.

Junta en EPDM.



DIV

d x d1	Ref.	PN	Pack	U/ 	€
16 x 12	DIV016012	16	10	1.000	2,54
20 x 16	DIV020016	16	10	1.000	0,74
25 x 20	DIV025020	16	10	600	0,91
32 x 20	DIV032020	16	10	400	1,09
32 x 25	DIV032025	16	10	400	1,00
40 x 20	DIV040020	16	10	240	1,60
40 x 25	DIV040025	16	10	240	1,60
40 x 32	DIV040032	16	10	240	1,26
50 x 32	DIV050032	16	10	120	2,17
50 x 40	DIV050040	16	10	120	1,54
63 x 32	DIV063032	16	-	70	2,89
63 x 40	DIV063040	16	-	70	2,89
63 x 50	DIV063050	16	-	60	2,05
75 x 50	DIV075050	16	-	56	4,33
75 x 63	DIV075063	16	-	56	3,65
90 x 50	DIV090050	16	-	100	6,92
90 x 63	DIV090063	16	-	100	6,92
90 x 75	DIV090075	16	-	100	5,99
110 x 63	DIV110063	16	-	60	13,30
110 x 75	DIV110075	16	-	60	13,15
110 x 90	DIV110090	16	-	60	11,57
125 x 110	DIV125110	16	-	12	15,10
140 x 90	DIV140090	16	-	16	21,49
140 x 110	DIV140110	16	-	16	22,95

Casquillo reducción encolar.
M-H encolar.

d = diám.macho
d1 = diám.hembra

A-B

d x d1	Ref.	PN	Pack	U/ 	€
140 x 125	DIV140125	16	-	16	20,47
160 x 90	DIV160090	16	-	9	29,08
160 x 110	DIV160110	16	-	9	30,28
160 x 140	DIV160140	16	-	9	26,77
180 x 160*	DIV180160	4	-	1	83,71
200 x 160*	1RRC121O00	16	-	10	51,77
200 x 180*	DIV200180	4	-	1	84,18
225 x 160 A)	DIV225160	16	-	6	69,69
225 x 200 A)*	DIV225200	16	-	6	56,72
250 x 160	DIV250160	10	-	6	121,31
250 x 180*	DIV250180	10	-	1	252,02
250 x 200	DIV250200	10	-	6	103,85
250 x 225	DIV250225	10	-	6	101,75
280 x 200*	DIV280200	10	-	1	284,49
280 x 225*	DIV280225	10	-	4	284,49
280 x 250*	DIV280250	10	-	1	284,49
315 x 200	DIV315200	10	-	3	306,95
315 x 225	DIV315225	10	-	3	311,46
315 x 250	DIV315250	10	-	4	304,58
315 x 280	DIV315280	10	-	4	304,26
400 x 280*	DIV400280	5	-	1	502,40
400 x 315*	DIV400315	5	-	1	435,19
400 x 355*	DIV400355	5	-	1	435,19

A) Factor de seguridad reducido



RIV

d x d2 x d1	Ref.	PN	U/	€
16 x 12	RIV016012	16	10 800	1,16
20 x 16	RIV020016	16	10 500	1,16
25 x 20 x 16	RIV025020016	16	10 400	1,24
25 x 20 x 20	RIV025020020	16	10 340	1,24
32 x 25 x 16	RIV032025016	16	10 280	1,24
32 x 25 x 20	RIV032025020	16	10 240	1,38
32 x 25 x 25	RIV032025025	16	10 200	1,38
40 x 32 x 20	RIV040032020	16	10 120	1,69
40 x 32 x 25	RIV040032025	16	10 120	1,69
40 x 32 x 32	RIV040032032	16	10 120	1,69
50 x 40 x 20	RIV050040020	16	10 80	2,46
50 x 40 x 25	RIV050040025	16	10 80	2,46
50 x 40 x 32	RIV050040032	16	10 80	2,46
50 x 40 x 40	RIV050040040	16	10 60	2,46
63 x 50 x 25	RIV063050025	16	- 40	3,94
63 x 50 x 32	RIV063050032	16	- 40	3,94
63 x 50 x 40	RIV063050040	16	- 40	3,94
63 x 50 x 50	RIV063050050	16	- 35	3,94

Reducción cónica encolar.

M-H encolar.

d = diámetro macho

d2 y d1 = diámetros hembra



MRIV*

d2 x d1	Ref.	PN	U/	€
125 x 110	MRIV125110	10	1	91,63
140 x 110	MRIV140110	10	1	122,22
140 x 125	MRIV140125	10	1	122,22
160 x 110	MRIV160110	10	1	125,51
160 x 125	MRIV160125	10	1	130,05
160 x 140	MRIV160140	10	1	125,51
200 x 110	MRIV200110	10	1	242,44
200 x 125	MRIV200125	10	1	242,44
200 x 140	MRIV200140	10	1	242,44
200 x 160	MRIV200160	10	1	242,44
200 x 180	MRIV200180	10	1	242,44
225 x 110	MRIV225110	10	1	311,75
225 x 125	MRIV225125	10	1	311,75
225 x 140	MRIV225140	10	1	302,88
225 x 160	MRIV225160	10	1	302,88
225 x 200	MRIV225200	10	1	302,88
250 x 110	MRIV250110	10	1	391,81
250 x 125	MRIV250125	10	1	391,81
250 x 140	MRIV250140	10	1	391,81
250 x 160	MRIV250160	10	1	380,72
250 x 180	MRIV250180	10	1	380,72
250 x 200	MRIV250200	10	1	380,72

Manguito reducido encolar.

H-H encolar.

A

d x d1	Ref.	PN	U/	€
75 x 63 x 50	RIV075063050	16	- 24	6,34
75 x 63 x 63	RIV075063063	16	- 24	6,34
90 x 75 x 50 x 40 B)	RIV090075040	16	- 24	8,24
90 x 75 x 63 x 50 B)	RIV090075050	16	- 16	8,24
90 x 75 x 75 x 63 B)	RIV090075063	16	- 24	8,24
90 x 75 x 90 x 75 B)	RIV090075075	16	- 12	8,24
110 x 90 x 50	RIV110090050	16	- 15	15,04
110 x 90 x 63	RIV110090063	16	- 12	15,04
110 x 90 x 75	RIV110090075	16	- 12	15,04
110 x 90 x 90	RIV110090090	16	- 10	15,04
125 x 110 x 63*	RIV125063	16	- 1	65,05
125 x 110 x 75*	RIV125075	16	- 1	55,27
125 x 110 x 90*	RIV125090	16	- 1	55,27
140 x 125 x 75*	RIV140075	16	- 1	92,10
140 x 125 x 90*	RIV140090	16	- 1	82,91
140 x 125 x 110*	RIV140110	16	- 1	82,91
160 x 140 x 90*	RIV160090	16	- 1	122,83
160 x x 110	RIV160110	16	- 12	35,92
200 x x 160	RIV200160	16	- 8	78,57

B) 4 diámetros M-H / M-H

A-B

d2 x d1	Ref.	PN	U/	€
250 x 225	MRIV250225	10	1	380,72
280 x 110	MRIV280110	10	1	446,75
280 x 125	MRIV280125	10	1	446,75
280 x 140	MRIV280140	10	1	446,75
280 x 160	MRIV280160	10	1	446,75
280 x 200	MRIV280200	10	1	434,11
280 x 225	MRIV280225	10	1	434,11
280 x 250	MRIV280250	10	1	434,11
315 x 160	MRIV315160	8	1	497,44
315 x 180	MRIV315180	8	1	497,44
315 x 200	MRIV315200	8	1	473,10
315 x 225	MRIV315225	8	1	473,10
315 x 250	MRIV315250	8	1	473,10
315 x 280	MRIV315280	8	1	473,10
355 x 315	MRIV355315	5	1	513,67
400 x 160	MRIV400160	5	1	638,99
400 x 225	MRIV400225	5	1	638,99
400 x 280	MRIV400280	5	1	638,99
400 x 315	MRIV400315	5	1	547,24
400 x 355	MRIV400355	5	1	580,78
500 x 400	MRIV500400	4	1	897,71

d2 y d1 = diámetros hembra

**CIV**

A-B

d	Ref.	PN	Pack	U/	€
12	CIV012	16	10	1.000	1,73
16	CIV016 ●	16	10	1.000	0,92
20	CIV020 ●	16	10	600	0,91
25	CIV025 ●	16	10	400	0,94
32	CIV032 ●	16	10	240	1,28
40	CIV040 ●	16	10	140	1,96
50	CIV050 ●	16	10	80	2,84
63	CIV063 ●	16	-	60	3,94
75	CIV075 ●	16	-	28	7,45
90	CIV090 ●	16	-	15	12,17
110	CIV110 ●	16	-	10	24,62
125	CIV125 ●	16	-	6	34,50
140	CIV140 ●	16	-	4	45,09
160	CIV160 ●	16	-	4	52,12
200*	CIV200 ●	10	-	7	75,00
225	CIV225 ●	10	-	2	121,85
250*	CIV250 ●	10	-	1	258,83

Tapón encolar hembra.

H encolar.**CFV**

A

Rh	Ref.	PN	Pack	U/	€
3/8"	1RCA216000	16	10	1.000	1,77
1/2"	CFV012 ●	16	10	500	1,74
3/4"	CFV034 ●	16	10	400	1,93
1"	CFV100 ●	16	10	200	2,39
1 1/4"	CFV114 ●	16	10	140	3,33
1 1/2"	CFV112 ●	16	10	90	4,34
2"	CFV200 ●	16	-	50	5,75
2 1/2"	CFV212 ●	16	-	70	21,47
3"*	CFV300 ●	16	-	20	22,01
4"*	CFV400 ●	16	-	60	37,91

Tapón rosca hembra.

H roscar.**PFV**

A

Rm	Ref.	PN	Pack	U/	€
3/8"	PFV038 ●	16	10	1.000	1,06
1/2"	PFV012 ●	16	10	300	1,26
3/4"	PFV034 ●	16	10	400	1,51
1"	PFV100 ●	16	10	260	2,12
1 1/4"	PFV114 ●	16	10	120	2,84
1 1/2"	PFV112 ●	16	10	100	3,68
2"	PFV200 ●	16	-	60	4,34
2 1/2"	PFV212 ●	16	-	36	7,72
3"	PFV300 ●	16	-	20	12,42
4"	PFV400 ●	16	-	8	24,31

Tapón rosca macho.

M roscar.**DFV**

A

Rm x Rh	Ref.	PN	Pack	U/	€
1/2" x 3/8"	DFV012038 ●	16	10	600	2,12
3/4" x 1/2"	DFV034012 ●	16	10	400	1,91
1" x 3/4"	DFV100034 ●	16	10	280	2,32
1 1/4" x 1"	DFV114100 ●	16	10	160	2,80
1 1/2" x 1 1/4"	DFV112114 ●	16	10	100	3,29
2" x 1 1/2"	DFV200112 ●	16	-	60	4,99

Reducción roscada corta.

M-H roscar.



KIFV

dm x dh x Rm	Ref.	PN	Pack	U/	€
16 x 12 x 3/8"	KIFV16012038	16	10	700	1,06
20 x 16 x 3/8"	KIFV20016038	16	10	700	1,19
20 x 16 x 1/2"	KIFV20016012	16	10	700	1,19
25 x 20 x 1/2"	KIFV25020012	16	10	350	1,42
25 x 20 x 3/4"	KIFV25020034	16	10	300	1,42
32 x 25 x 1/2"	KIFV32025012	16	10	220	1,57
32 x 25 x 3/4"	KIFV32025034	16	10	200	1,57
32 x 25 x 1"	KIFV32025100	16	10	180	1,57
40 x 32 x 3/4"	KIFV40032034	16	10	120	2,12
40 x 32 x 1"	KIFV40032100	16	10	120	2,12
40 x 32 x 1 1/4"	KIFV40032114	16	10	100	2,12
50 x 40 x 1"	KIFV50040100	16	10	100	2,75
50 x 40 x 1 1/4"	KIFV50040114	16	10	100	2,75
50 x 40 x 1 1/2"	KIFV50040112	16	10	100	2,72

Terminal rosca macho.

M/H encolar - M roscar

A

dm x dh x Rm	Ref.	PN	Pack	U/	€
63 x 50 x 1 1/4"	KIFV63050114	16	-	80	4,48
63 x 50 x 1 1/2"	KIFV63050112	16	-	80	4,48
63 x 50 x 2"	KIFV63050200	16	-	70	4,42
75 x 63 x 1 1/2"	KIFV75063112	16	-	55	7,12
75 x 63 x 2"	KIFV75063200	16	-	50	7,12
75 x 63 x 2 1/2"	KIFV75063212	16	-	40	7,12
90 x 75 x 2"	KIFV90075200	16	-	30	10,34
90 x 75 x 2 1/2"	KIFV90075212	16	-	30	10,34
90 x 75 x 3"	KIFV90075300	16	-	24	10,34
110 x 90 x 2 1/2"	KIFV11090212	16	-	12	23,92
110 x 90 x 3"	KIFV11090300	16	-	20	23,92
110 x 90 x 4"	KIFV11090400	16	-	12	23,92
125 x 110 x 3"	KIFV12110300	16	-	8	26,08
125 x 110 x 4"	KIFV12110400	16	-	6	26,33

dm = diámetro macho dh = diámetro hembra

Rm = rosca macho



NFV

Rh	Ref.	PN	Pack	U/	€
3/8"	NFV038	16	10	800	1,42
1/2"	NFV012	16	10	500	1,50
3/4"	NFV034	16	10	260	1,74
1"	NFV100	16	10	160	2,11
1 1/4"	NFV114	16	10	80	2,64
1 1/2"	NFV112	16	10	70	3,47
2"	NFV200	16	-	30	4,42
2 1/2" A)	NFV212	16	-	24	7,79
3" A)	NFV300	16	-	16	12,16
4" A)	NFV400	16	-	6	28,65

Machón doble rosca.

M-M roscar.

A) Factor de seguridad reducido

A

RFV

Rm x Rh	Ref.	PN	Pack	U/	€
1/2" x 3/8"	RFV012038	16	10	500	2,04
3/4" x 3/8"	RFV034038	16	10	400	2,26
3/4" x 1/2"	RFV034012	16	10	320	2,19
1" x 3/8"	RFV100038	16	10	240	2,66
1" x 1/2"	RFV100012	16	10	200	2,52
1" x 3/4"	RFV100034	16	10	200	2,52
1 1/4" x 1/2"	RFV114012	16	10	100	3,18
1 1/4" x 3/4"	RFV114034	16	10	80	3,18
1 1/4" x 1"	RFV114100	16	10	80	3,08
1 1/2" x 1/2"	RFV112012	16	10	80	3,59
1 1/2" x 3/4"	RFV112034	16	10	80	3,61
1 1/2" x 1"	RFV112100	16	10	80	3,58
1 1/2" x 1 1/4"	RFV112114	16	10	80	3,58
2" x 3/4"	RFV200034	16	-	50	5,35
2" x 1"	RFV200100	16	-	40	5,35
2" x 1 1/4"	RFV200114	16	-	40	5,43
2" x 1 1/2"	RFV200112	16	-	40	5,26
2 1/2" x 2"	RFV212200	16	-	36	7,14
3" x 2"	RFV300200	16	-	20	8,91
3" x 2 1/2"	RFV300212	16	-	20	12,36
4" x 3"	RFV400300	16	-	8	28,44

Reducción roscada.

M-H roscar

A

**NRFV**

A

Rm x Rm	Ref.	PN	Pack	U/ 	€
¾" x ½"	NRFV034012	16	10	300	1,56
1" x ¾"	NRFV100034	16	10	200	2,03
1¼" x 1"	NRFV114100	16	10	120	2,50
1½" x 1¼"	NRFV112114	16	10	80	3,05
2" x 1½"	NRFV200112	16	-	40	3,83
2½" x 2"	NRFV212200	16	-	24	7,14
3" x 2½"	NRFV300212	16	-	16	11,55
4" x 3"	NRFV400300	16	-	8	26,56

Machón reducido roscado.

M-M roscar.**NRIV**

A

Rm x Rh	Ref.	Pack	U/ 	€
25 x 1"	NRIV025100	10	120	5,57
32 x 1¼"	NRIV032114	10	60	7,21

Adaptador M-M.

M encolar - roscar.**IFFV**

A

Rh x Rm	Ref.	PN	Pack	U/ 	€
¾" x ½"	IFFV034012	16	10	280	2,22
1" x ½"	IFFV100012	16	10	140	8,99
1" x ¾"	IFFV100034	16	10	140	2,58
1¼" x 1"	IFFV114100	16	10	80	3,07
1½" x 1¼"	IFFV112114	16	10	40	3,70
2" x 1½"	IFFV200112	16	-	30	4,96
2½" x 2"	IFFV212200	16	-	20	32,79
3" x 2½"	IFFV300212	16	-	16	19,42
4" x 3"	IFFV400300	16	-	8	95,80

Reducción roscada.

H-M roscar.**JFV**

A

Rh	Ref.	PN	Pack	U/ 	€
½"	JFV012	16	25	1.000	10,74
¾"	JFV034	16	25	750	11,44
1"	JFV100	16	25	400	12,52
1¼"	JFV114	16	10	300	13,75
1½"	JFV112	16	10	200	Consultar
2"	JFV200	16	10	120	Consultar

Tuerca fina.

H roscar. Para adaptador depósito LIV y LIFV.

**BIV**

A

d	Ref.	PN	Pack	U/	€ EPDM
16	BIV016E	16	10	300	3,40
20	BIV020E	16	10	180	3,35
25	BIV025E	16	10	100	3,85
32	BIV032E	16	10	70	5,46
40	BIV040E	16	10	40	6,57
50	BIV050E	16	10	90	8,03
63	BIV063E	16	5	45	11,73
75	BIV075E	10	-	28	34,07
90	BIV090E	10	-	22	45,09
110	BIV110E	10	-	12	65,96

Unión 3 piezas encolar.
H-H encolar. Junta en EPDM.

Para recambios consultar
el apartado "Recambios"
de esta misma tarifa

**BIFV**

A

d	Ref.	PN	Pack	U/	€ EPDM
16 x 3/8"	BIFV016038E	16	10	300	3,84
20 x 1/2"	BIFV020012E	16	10	180	3,90
25 x 3/4"	BIFV025034E	16	10	100	4,60
32 x 1"	BIFV032100E	16	10	60	6,18
40 x 1 1/4"	BIFV040114E	16	10	40	7,75
50 x 1 1/2"	BIFV050112E	16	10	90	9,29
63 x 2"	BIFV063200E	16	5	60	13,54
75 x 2 1/2"	BIFV075212E	10	-	28	37,82
90 x 3"	BIFV090300E	10	-	22	48,29
110 x 4"	BIFV110400E	10	-	12	76,72

Unión 3 piezas mixto.
H-H encolar - roscar. Junta en EPDM.

Para recambios consultar
el apartado "Recambios"
de esta misma tarifa

**BIRV**

A

d x Rm	Ref.	PN	Pack	U/	€ EPDM
20 x 1/2" *	BIRV020012E	16	-	25	4,90
25 x 3/4" *	BIRV025034E	16	-	30	5,46
32 x 1" *	BIRV032100E	16	-	50	7,04
40 x 1 1/4" *	BIRV040114E	16	-	36	8,17
50 x 1 1/2"	BIRV050112E	16	10	80	9,74
50 x 2"	BIRV050200E	16	10	80	14,74
63 x 2"	BIRV063200E	16	5	35	13,48
75 x 2 1/2" *	BIRV075212E	16	-	12	41,31
90 x 3" *	BIRV090300E	16	-	18	54,08

Unión 3 piezas mixto.
H-M encolar - roscar. Junta en EPDM.

Para recambios consultar
el apartado "Recambios"
de esta misma tarifa

**BFV**

A

Rh	Ref.	PN	Pack	U/	€ EPDM
3/8"	BFV038E	16	10	300	4,39
1/2"	BFV012E	16	10	180	4,69
3/4"	BFV034E	16	10	100	5,56
1"	BFV100E	16	10	60	7,40
1 1/4"	BFV114E	16	10	40	9,31
1 1/2"	BFV112E	16	10	90	10,96
2"	BFV200E	16	5	60	15,57
2 1/2" **	1RBO275000	10	-	15	68,25
3" **	1RBO290000	6	-	12	73,27
4" **	1RBO211000	6	-	12	83,41

Unión 3 piezas roscado.
H-H roscar. Junta en EPDM.

Para recambios consultar
el apartado "Recambios"
de esta misma tarifa

**BIFOV**

A

d x Rh	Ref.	PN	Pack	U/	€ EPDM
16 x 3/8"	BIFOV016038E	16	50	100	14,11
20 x 1/2"	BIFOV020012E	16	40	80	18,29
25 x 3/4"	BIFOV025034E	16	20	40	23,32
32 x 1"	BIFOV032100E	16	14	28	29,33
40 x 1 1/4"	BIFOV040114E	16	8	16	41,26
50 x 1 1/2"	BIFOV050112E	16	4	8	51,52
63 x 2"	BIFOV063200E	16	-	12	83,83

Unión 3 piezas mixto PVC-U / Latón.
H-H encolar - roscar latón. Junta en EPDM.

Para recambios consultar
el apartado "Recambios"
de esta misma tarifa

**BIROV**

A

d	Ref.	PN	Pack	U/	€ EPDM
16 x 3/8"	BIROV016038E	16	50	100	16,95
20 x 1/2"	BIROV020012E	16	35	70	19,77
25 x 3/4"	BIROV025034E	16	15	30	25,86
32 x 1"	BIROV032100E	16	12	24	33,23
40 x 1 1/4"	BIROV040114E	16	8	16	48,26
50 x 1 1/2"	BIROV050112E	16	4	8	57,52
63 x 2"	BIROV063200E	16	-	10	99,43

Unión 3 piezas mixto PVC-U / Latón.
H-M encolar - roscar latón. Junta en EPDM.

Para recambios consultar
el apartado "Recambios"
de esta misma tarifa

**BIFXV**

A

d x Rh	Ref.	PN	Pack	€ EPDM	€ FKM
16 x 3/8"	BIFXV016038E	16	50	49,23	52,23
20 x 1/2"	BIFXV020012E	16	40	52,59	55,76
25 x 3/4"	BIFXV025034E	16	20	60,28	63,18
32 x 1"	BIFXV032100E	16	14	69,49	73,24
40 x 1 1/4"	BIFXV040114E	16	8	98,48	101,99
50 x 1 1/2"	BIFXV050112E	16	4	108,56	114,89
63 x 2"	BIFXV063200E	16	-	138,07	144,46

Unión 3 piezas mixto
PVC-U / Inox A316L.
H-H encolar - roscar inox.
Junta en EPDM o FKM.

Código en FKM termina en "F"
en lugar de "E"
Para recambios consultar
el apartado "Recambios"
de esta misma tarifa

**BIRXV**

A

d x Rm	Ref.	PN	Pack	€ EPDM	€ FKM
16 x 3/8"	BIRXV016038E	16	50	52,82	55,54
20 x 1/2"	BIRXV020012E	16	35	55,96	58,89
25 x 3/4"	BIRXV025034E	16	15	62,96	65,68
32 x 1"	BIRXV032100E	16	12	71,02	75,21
40 x 1 1/4"	BIRXV040114E	16	8	98,52	105,85
50 x 1 1/2"	BIRXV050112E	16	4	117,02	122,75
63 x 2"	BIRXV063200E	16	-	161,60	176,41

Unión 3 piezas mixto
PVC-U / Inox A316L.
H-M encolar - roscar inox.
Junta en EPDM o FKM.

Código en FKM termina en "F"
en lugar de "E"
Para recambios consultar
el apartado "Recambios"
de esta misma tarifa

**ADV**

A

Rh x P1 x P2	Ref.	PN	Pack	U/	€ EPDM
1/2" x 12 x 14	ADV012012014	16	5	300	2,99
3/4" x 16 x 18	ADV034016018	16	5	200	3,65
1" x 20 x 22	ADV100020022	16	5	160	4,15
1 1/4" x 25 x 27	ADV114025027	16	5	80	4,74
1 1/2" x 30 x 32	ADV112030032	16	5	50	6,14
2" x 40 x 42	ADV200040042	16	5	30	5,99
2" x 50 x 52	ADV200050052	16	5	25	7,39
2 1/4" x 50 x 52	ADV214050052	16	5	20	17,94
2 3/4" x 60 x 64	ADV234060064	16	3	21	8,83

Espiga con tuerca.
H-M roscar - presión. Junta en EPDM.

**ADV-J**

A

R x P1 x P2	Ref.	€ EPDM
1/2" x 12 x 14	GP1210E	0,64
3/4" x 16 x 18	GP0193E	0,72
1" x 20 x 22	GP1212E	0,72
1 1/4" x 25 x 27	QH VX025E	1,18
1 1/2" x 30 x 32	GP0196E	0,98
2" x 40 x 42	GP0197E	1,42
2" x 50 x 52	GP0197E	1,42
2 1/4" x 50 x 52	GP0198E	1,84
2 3/4" x 60 x 64	QH VX050E	2,45
3" x 60 x 64	GPO0199E	2,79

Junta plana EPDM
Para espiga con tuerca ADV

**AIV**

A

d x P2 x P1	Ref.	PN	Pack	U/	€ EPDM
12 x 14 x 12	AIV012014012	16	10	1.000	1,08
16 x 18 x 16	AIV016018016	16	10	600	1,09
20 x 22 x 20	AIV020022020	16	10	500	1,36
25 x 27 x 25	AIV025027025	16	10	200	1,66
32 x 32 x 30	AIV032032030	16	10	100	2,10
40 x 42 x 40	AIV040042040	16	5	100	2,47
50 x 52 x 50	AIV050052050	16	5	40	3,52
63 x 64 x 60	AIV063064060	16	-	40	4,44

Espiga encolar macho.
M-M encolar - presión.

**AFV**

A

Rm x P1 x P2	Ref.	PN	Pack	U/	€
1/4" x 12 x 14	AFV014012014	16	10	1.000	1,09
3/8" x 16 x 18	AFV038016018	16	10	600	1,06
1/2" x 20 x 22	AFV012020022	16	10	300	1,36
3/4" x 25 x 27	AFV034025027	16	10	160	1,61
1" x 30 x 32	AFV100030032	16	10	100	2,10
1 1/4" x 40 x 42	AFV114040042	16	5	50	2,50
1 1/2" x 50 x 52	AFV112050052	16	5	30	3,59
2" x 60 x 64	AFV200060064	16	-	20	4,50

Espiga rosca macho.
M-M roscar - presión.

**PINZA***

A

d	Ref.	Pack	€
16**	1RST116000	10	0,92
20**	1RST120000	10	0,85
25**	1RST125000	10	1,03
32**	1RST132000	10	1,20
40	1RST140000	10	2,42
50	1RST150000	10	3,05
63	1RST163000	10	3,56
75	1RST175000	10	4,69
90	1RST190000	10	6,19
110	1RST111000	10	7,24

Abrazadera para tubería PP gris.
Marca *ASTORE*.

** En estos diámetros
sin cierre superior

**ZIKM**

A

d	Ref.	Pack	U/	€
16	ZIKM016	10	800	2,35
20	ZIKM020	10	600	2,52
25	ZIKM025	10	160	2,60
32	ZIKM032	10	240	3,10
40	ZIKM040	10	160	3,80
50	ZIKM050	10	100	4,38
63	ZIKM063	10	80	5,40
75	ZIKM075	-	80	7,66
90	ZIKM090	-	40	9,35
110	ZIKM110	-	30	13,03
125	ZIKM125	-	20	17,68
140	ZIKM140	-	20	18,47
160	ZIKM160	-	10	21,24
180	ZIKM180	-	10	19,42

Abrazadera para tubería PP gris.



	Ref.	U/	n.º	€/Unid.
125 ml	035001	96	A-8	6,13
Bote 250 ml	035008	24	A-11	13,42
Bote 500 ml	035002	20	A-8	18,64
Bote 1.000 ml	035003	12	A-8	30,99

Adhesivo NEW GENERATION.

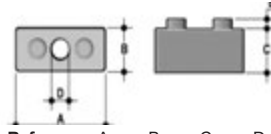
**DSM**

A

d	Ref.	A	B	C	D	E	€
32	DSM032	33	16	14	8	4	1,66
40	DSM040	41	17	17	8	4	2,26
50	DSM050	51	18	17	8	4	3,04
63	DSM063	64	19	22,5	8	4	4,00
75	DSM075	76	20	34,5	8	4	5,52

Soporte en PP para abrazadera ZIKM.



	Ref.	U/	n.º	€/Unid.
Bote 500 ml	035007	24	A-8	11,18

Limpiador.
Desengordurante.

Lleva el agua y la energía de forma sostenible sin límites

Sistemas de conducción de fluidos

Infraestructura

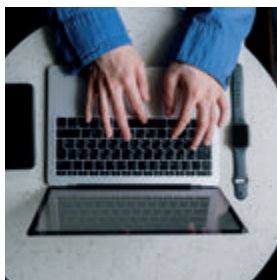

Comunicaciones



Protección contra incendios



Suministro de agua



Suministro de gas e hidrógeno

Industria



Procesos industriales



Medición y control

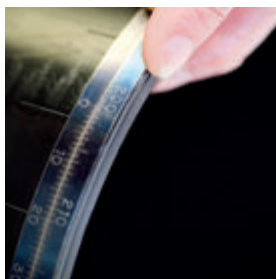

Prefabricado industrial

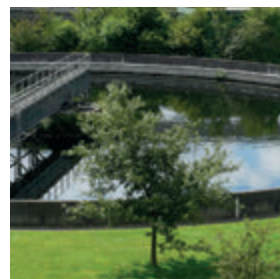

Tratamiento de agua

 **Seguridad**  **Calidad**  **Durabilidad**  **Fácil instalación**

Descarga nuestro catálogo de soluciones



Grupo internacional con dos plantas de fabricación en España
Alicante _____ Okondo
+ 45 países

Válvulas de bola 2 y 3 vías

Válvulas de mariposa

Válvulas y grifos de membrana

Válvulas de retención

Filtros inclinados

Accesorios para válvulas manuales

Válvulas manuales en PVC-U presión

INDUSTRIA



Bloqueo de las tuercas

Para asegurar la PN y aflojes por vibraciones elevadas



Válvulas de bola

Tapón portaetiqueta

Tapón para personalizar o señalar la válvula.



Bidireccional. Sin dirección de montaje. Sin flecha en el cuerpo

Plena libertad y seguridad a la hora del montaje. Se pueden instalar sin necesidad de seguir la dirección de montaje. Mucho más fácil y sin riesgo de que se desmonte o bloquee la bola por la presión del fluido al desmontar el extremo que da acceso a la misma. Tampoco se bloquea la bola si nos excedemos al apretar los extremos. Por tanto el eje no sufre ni se rompe.

Tapón de protección transparente con porta etiqueta para el sistema de Labelling Easyfit (opcional)

Optional transparent service plug with tag holder for Easyfit Labelling system



Tapón de protección estándar
Grey standard service plug

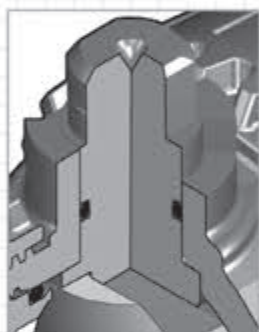

Eje y esfera de tipo flotante de alta finura superficial

High finishing stem and floating ball

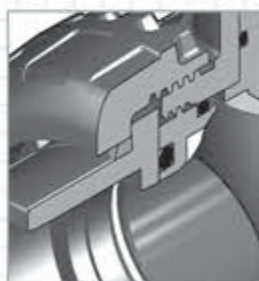

Casquillo roscado de seguridad

Safe blocked carrier



Montaje radial según norma EN 1452 "short"

True union installation according to EN 1452 "short"



Gama VEE

Maneta multifunción Easyfit
Easyfit multifunctional handle

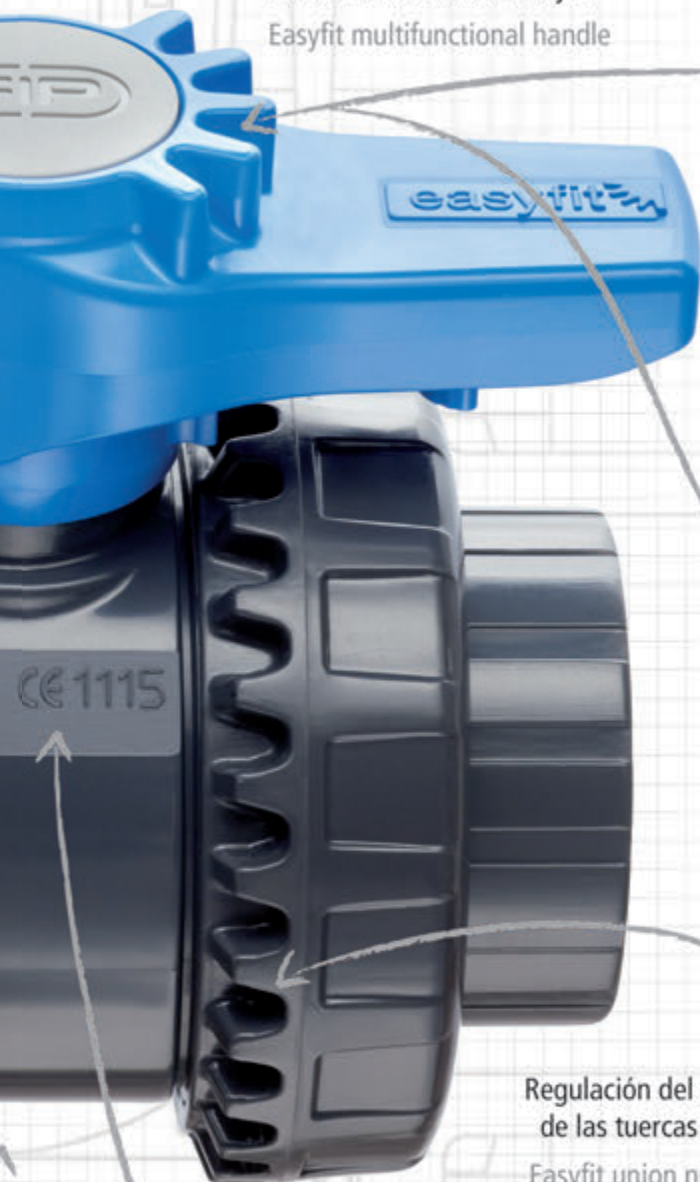

Control rotación tuercas
Union nut rotation control



Regulación casquillo estanco y bola
Ball seat carrier adjustment



Regulación del apriete
de las tuercas Easyfit
Easyfit union nut gear
tightening



Cuerpo de la válvula PN16
Certificado 97/23/CE
Valve body PN16
97/23/CE Certified



Sistema de etiquetado:

sistema completo de etiquetado que identifica la válvula según necesidades específicas.

Labelling System:

complete tagging system that allows the identification of the valve according to specific needs.



Rendimiento y seguridad:

válvula ligera y compacta con cuerpo PN16 en PVC-U K62 o PVC-C Corzan y doble junta tórica en el eje de la válvula. El acabado de gran calidad de la bola, el asiento de bola y el disco anti-fricción en PTFE situado en la base del eje minimizan las fricciones logrando un excelente funcionamiento de par de torsión.



The high surface finished ball, the PTFE ball seat and the PTFE anti-friction disc located at the base of the stem minimize the frictions achieving excellent operating torque.

Performance and safety:

light and compact valve with PN16 body in PVC-U K62 or PVC-C Corzan™ and double O-ring seal on the valve stem.

The high surface finished ball, the PTFE ball



Fácil accionamiento:

el cuerpo de la válvula tiene una estructura integrada para fijar el kit de actuación PowerQuick, específico para la instalación de actuadores neumáticos y eléctricos.

Easy

actuation:

the valve body has an integrated structure for anchoring the special PowerQuick module, dedicated to the installation of pneumatic and electric actuators.

Cerradura a prueba de manipulaciones:

la válvula está equipada con un sistema simple que evita la rotación de la maneta tanto de apertura como de cierre mediante un candado.

Tamper-proof lock:

the valve is equipped with a simple system that avoid the handle rotation both for opening and closing operations inputting a padlock.





Gama VXE

Maneta multifuncional Easyfit
Easyfit multifunctional handle

Maneta multifunción Easyfit de rápida extracción:

para usar la maneta como herramienta multifuncional para apretar las tuercas de unión y ajustar el soporte de asiento de bola se puede extraer del dado con una simple maniobra permaneciendo firme al eje que se está maniobrando.



Easyfit Quick-release multifunctional handle:

the handle, to be used as multifunction tool for union nuts tightening and ball seat carrier adjustment can be removed with a simple operation from the hub which remains firmly coupled to the maneuvering stem.



Bisel giratorio con la maneta multifuncional Easyfit:

el uso del gancho alojado en el interior de la maneta permite crear una llave para el ajuste de las tuercas de unión que asegura un acoplamiento seguro y sólido.



Union nut tightening with Easyfit multifunctional handle:

the use of the hooked insert housed inside the handle allows to realize a key for the union nuts rotation that ensures a secure and solid engagement.

Ajuste del casquillo de la bola de apoyo con la maneta multifuncional Easyfit.

Ball seat carrier adjustment with Easyfit multifunctional handle.





Maneta multifunción
Multi functional handle



Kit de montaje para actuadores
Mounting flange



Soporte de fijación
Bracketing



Gama VKD

Válvula industrial



Conexión eje y bola
Stem-ball connection

Soporte del asiento de la bola
Safe blocked carrier

Dual Block
Dual Block



Cuerpo
Body





INDUSTRIA

Válvulas manuales de PVC-U presión

Válvulas de bola 2 vías



VEEIV

C

d	Ref.	DN	PN	U/	€ EPDM
16	VEEIV016E	10	16	60	16,77
20	VEEIV020E	15	16	60	16,77
25	VEEIV025E	20	16	40	18,53
32	VEEIV032E	25	16	25	24,31
40	VEEIV040E	32	16	14	28,33
50	VEEIV050E	40	16	15	38,72
63	VEEIV063E	50	16	8	52,71

Válvula de bola maneta azul.

H-H encolar. Junta EPDM - Asiento PE. Bidireccional.



VEEFV

C

Rh	Ref.	DN	PN	U/	€ EPDM
3/8"	VEEFV038E	10	16	60	17,61
1/2"	VEEFV012E	15	16	60	17,61
3/4"	VEEFV034E	20	16	40	19,41
1"	VEEFV100E	25	16	25	25,76
1 1/4"	VEEFV114E	32	16	14	30,23
1 1/2"	VEEFV112E	40	16	15	41,26
2"	VEEFV200E	50	16	8	56,05

Válvula de bola maneta azul.

H-H roscar. Junta EPDM - Asiento PE. Bidireccional.



VEEIV

C

d	Ref.	DN	PN	U/	€ EPDM
75	VEEIV075E	65	16	2	156,57
90	VEEIV090E	80	16	2	213,12
110	VEEIV110E	100	16	1	380,96

Válvula de bola maneta azul.

H-H encolar. Junta EPDM - Asiento PE. Bidireccional.



VEEFV

C

Rh	Ref.	DN	PN	U/	€ EPDM
2 1/2"	VEEFV212E	65	16	2	164,54
3"	VEEFV300E	80	16	2	221,53
4"	VEEFV400E	100	16	1	401,97

Válvula de bola maneta azul.

H-H roscar. Junta EPDM - Asiento PE. Bidireccional.

Para recambios de las válvulas consultar el último apartado "Recambios" de esta misma tarifa.

VXEIV

C

d	Ref. EPDM	DN	PN	U/	€ EPDM	€ FKM
16	VXEIV016E	10	16	30	21,51	25,74
20	VXEIV020E	15	16	30	21,60	25,85
25	VXEIV025E	20	16	30	25,53	30,92
32	VXEIV032E	25	16	20	30,00	36,30
40	VXEIV040E	32	16	14	39,04	46,16
50	VXEIV050E	40	16	6	48,02	56,56
63	VXEIV063E	50	16	6	63,94	81,95

Válvula de bola maneta naranja. Código en FKM termina en "F" en lugar de "E"
 H-H encolar. Asiento PTFE (teflón).
 Bidireccional.

VXEFV

C

Rh	Ref. EPDM	DN	PN	U/	€ EPDM	€ FKM
3/8"	VXEFV038E	10	16	30	23,66	28,22
1/2"	VXEFV012E	15	16	30	23,75	28,22
3/4"	VXEFV034E	20	16	30	28,02	33,48
1"	VXEFV100E	25	16	20	33,63	39,90
1 1/4"	VXEFV114E	32	16	14	43,70	50,80
1 1/2"	VXEFV112E	40	16	6	52,83	61,33
2"	VXEFV200E	50	16	6	78,04	95,98

Válvula de bola maneta naranja. Código en FKM termina en "F" en lugar de "E"
 H-H roscar. Asiento PTFE (teflón).
 Bidireccional.

VXEIV

C

d	Ref. EPDM	DN	PN	€ EPDM	€ FKM
75	VXEIV075E	65	16	169,41	186,37
90	VXEIV090E	80	16	230,69	253,74
110	VXEIV110E	100	16	473,87	521,24

Válvula de bola maneta naranja. Código en FKM termina en "F" en lugar de "E"
 H-H encolar. Asiento PTFE (teflón).
 Bidireccional.

VXEFV

C

Rh	Ref. EPDM	DN	PN	€ EPDM	€ FKM
2 1/2"	VXEFV212E	65	16	190,17	368,01
3"	VXEFV300E	80	16	251,93	458,37
4"	VXEFV400E	100	16	529,33	583,55

Válvula de bola maneta naranja. Código en FKM termina en "F" en lugar de "E"
 H-H roscar. Asiento PTFE (teflón).
 Bidireccional.

Para recambios de las válvulas consultar el último apartado "Recambios" de esta misma tarifa.

VPE*

C

Rh x d	Ref. EPDM	PN	U/ 	€ EPDM
3/8" x 16	VPE038016	16	120	16,08
1/2" x 20	VPE012020	16	100	16,08
3/4" x 25	VPE034025	16	60	18,52
1" x 32	VPE100032	16	40	20,46
1 1/4" x 40	VPE114040	16	20	31,61
1 1/2" x 50	VPE112050	16	15	36,32
2" x 63	VPE200063	16	8	54,81

Válvula de bola.
PVC roscar hembra. Enlace PE H.

Terminales PE se entregan
aparte incluidos en el precio

VKDFV

D

Rh	Ref. EPDM	DN	PN	€ EPDM	€ FKM
3/8"	VKDFV038E	10	16	52,76	63,85
1/2"	VKDFV012E	15	16	55,29	66,16
3/4"	VKDFV034E	20	16	66,16	76,75
1"	VKDFV100E	25	16	81,24	102,30
1 1/4"	VKDFV114E	32	16	103,19	120,61
1 1/2"	VKDFV112E	40	16	135,28	157,28
2"	VKDFV200E	50	16	170,40	214,08

Válvula de bola DUAL BLOCK®.
H-H roscar. Asiento PTFE (teflón).
Bidireccional.

Código en FKM termina en "F"
en lugar de "E"

VKDIV

D

d	Ref. EPDM	DN	PN	€ EPDM	€ FKM
16	VKDIV016E	10	16	48,93	59,31
20	VKDIV020E	15	16	50,92	60,94
25	VKDIV025E	20	16	60,26	73,05
32	VKDIV032E	25	16	75,04	90,74
40	VKDIV040E	32	16	93,45	110,51
50	VKDIV050E	40	16	120,46	141,82
63	VKDIV063E	50	16	149,99	192,16

Válvula de bola DUAL BLOCK®.
H-H encolar. Asiento PTFE (teflón).
Bidireccional.

Código en FKM termina en "F"
en lugar de "E"

VKDFV

D

Rh	Ref. EPDM	DN	PN	€ EPDM	€ FKM
2 1/2"	VKDFV212E	65	16	487,96	577,01
3"	VKDFV300E	80	16	621,67	730,28
4"	VKDFV400E	100	16	699,12	848,98

Válvula de bola DUAL BLOCK®.
H-H roscar. Asiento PTFE (teflón).
Bidireccional.

Código en FKM termina en "F"
en lugar de "E"

VKDIV

D

d	Ref. EPDM	DN	PN	€ EPDM	€ FKM
75	VKDIV075E	65	16	451,81	540,85
90	VKDIV090E	80	16	575,63	684,22
110	VKDIV110E	100	16	647,33	797,16

Válvula de bola DUAL BLOCK®.
H-H encolar. Asiento PTFE (teflón).
Bidireccional.

Código en FKM termina en "F"
en lugar de "E"



M1

d	Ref.	DN	PN	€
140	052322	125	10	735,10

Válvula de bola PASO TOTAL con bridas
Sugerencia tornillería M6x100

Para recambios de las válvulas consultar el último apartado "Recambios" de esta misma tarifa.

**VKDDV**

D

d	Ref. EPDM	DN	PN	€ EPDM	€ FKM
16	VKDDV016E	10	16	48,93	59,31
20	VKDDV020E	15	16	50,92	60,94
25	VKDDV025E	20	16	60,26	73,05
32	VKDDV032E	25	16	75,04	90,74
40	VKDDV040E	32	16	93,45	110,51
50	VKDDV050E	40	16	120,46	141,82
63	VKDDV063E	50	16	149,99	192,16

Válvula de bola DUAL BLOCK®. Código en FKM termina en "F" en lugar de "E"
 M-M encolar. Asiento PTFE (teflón). Bidireccional.

**VKDBEV**

D

d	Ref. EPDM	DN	PN	€ EPDM	€ FKM
20	VKDBEV020E	15	16	61,46	84,20
25	VKDBEV025E	20	16	61,80	80,36
32	VKDBEV032E	25	16	71,31	95,82
40	VKDBEV040E	32	16	92,37	120,93
50	VKDBEV050E	40	16	114,03	148,78
63	VKDBEV063E	50	16	149,66	199,31

Válvula de bola DUAL BLOCK®. Código en FKM termina en "F" en lugar de "E"
 Long spigot PE100 SDR11. Asiento PTFE (teflón). Bidireccional.

**VKDDV**

D

d	Ref. EPDM	DN	PN	€ EPDM	€ FKM
75	VKDDV075E	65	16	451,81	540,85
90	VKDDV090E	80	16	575,63	684,22
110	VKDDV110E	100	16	647,33	797,16

Válvula de bola DUAL BLOCK®. Código en FKM termina en "F" en lugar de "E"
 M-M encolar. Asiento PTFE (teflón). Bidireccional.

**VKDBEV**

D

d	Ref. EPDM	DN	PN	€ EPDM	€ FKM
75	VKDBEV075E	65	16	497,00	586,06
90	VKDBEV090E	80	16	633,19	741,80
110	VKDBEV110E	100	16	712,04	861,90

Válvula de bola DUAL BLOCK®. Código en FKM termina en "F" en lugar de "E"
 Long spigot PE100 SDR11. Asiento PTFE (teflón). Bidireccional.

**VKROV**

D

d	Ref. EPDM	DN	PN	€ EPDM	€ FKM
20	VKROV020E	15	16	243,63	243,63
25	VKROV025E	20	16	273,88	273,88
32	VKROV032E	25	16	323,03	323,03
40	VKROV040E	32	16	355,66	355,66
50	VKROV050E	40	16	451,26	451,26
63	VKROV063E	50	16	492,19	492,19

Válvula de bola REGULACIÓN DUALBLOCK®. Código en FKM termina en "F" en lugar de "E"
 Con bridas DIN 2501. Asiento PTFE (teflón). Bidireccional.

**VKROAV**

D

d	Ref. EPDM	DN	PN	€ EPDM	€ FKM
1/2"	VKROAV012E	15	16	243,63	243,63
3/4"	VKROAV034E	20	16	273,88	273,88
1"	VKROAV100E	25	16	323,03	323,03
1 1/4"	VKROAV114E	32	16	355,66	355,66
1 1/2"	VKROAV112E	40	16	451,26	451,26
2"	VKROAV200E	50	16	492,19	492,19

Válvula de bola REGULACIÓN DUALBLOCK®. Código en FKM termina en "F" en lugar de "E"
 Con bridas ANSI 150 lbs. Asiento PTFE (teflón). Bidireccional.

Para recambios de las válvulas consultar el último apartado "Recambios" de esta misma tarifa.

**VKDOV**

D

d	Ref. EPDM	DN	PN	€ EPDM	€ FKM
20	VKDOV020E	15	16	145,06	150,47
25	VKDOV025E	20	16	170,06	176,32
32	VKDOV032E	25	16	239,32	189,84
40	VKDOV040E	32	16	225,14	234,94
50	VKDOV050E	40	16	250,12	270,60
63	VKDOV063E	50	16	288,84	318,47

Válvula de bola DUAL BLOCK®.
Con brida loca. Asiento PTFE (teflón).
Bidireccional.

Código en FKM termina en "F"
en lugar de "E"
Versión con bridas ANSI 150 lbs
al mismo precio

**VKRIV**

D

d	Ref. EPDM	DN	PN	€ EPDM	€ FKM
16	VKRIV016E	10	16	199,56	209,95
20	VKRIV020E	15	16	201,55	211,55
25	VKRIV025E	20	16	226,42	239,21
32	VKRIV032E	25	16	271,84	287,49
40	VKRIV040E	32	16	287,11	304,20
50	VKRIV050E	40	16	375,76	397,11
63	VKRIV063E	50	16	391,35	433,51

Válvula de bola REGULACIÓN
DUALBLOCK®.

H-H encolar. Asiento PTFE (teflón).
Bidireccional.

Código en FKM termina en "F"
en lugar de "E"

**VKDOV**

D

d	Ref. EPDM	DN	PN	€ EPDM	€ FKM
75	VKDOV075E	65	16	688,60	739,05
90	VKDOV090E	80	16	867,02	959,42
110	VKDOV110E	100	16	1.090,49	1.209,29

Válvula de bola DUAL BLOCK®.
Con brida loca. Asiento PTFE (teflón).
Bidireccional. DIN y ANSI 150 Lbs.

Código en FKM termina en "F"
en lugar de "E"

**VKRFV**

D

Rh	Ref. EPDM	DN	PN	€ EPDM	€ FKM
3/8"	VKRFV038E	10	16	203,41	203,41
1/2"	VKRFV012E	15	16	205,91	205,91
3/4"	VKRFV034E	20	16	232,32	232,32
1"	VKRFV100E	25	16	277,96	277,96
1 1/4"	VKRFV114E	32	16	296,89	296,89
1 1/2"	VKRFV112E	40	16	390,57	390,57
2"	VKRFV200E	50	16	411,79	411,80

Válvula de bola REGULACIÓN
DUALBLOCK®.

H-H roscar. Asiento PTFE (teflón).
Bidireccional.

Código en FKM termina en "F"
en lugar de "E"

**VKRDV**

D

d	Ref. EPDM	DN	PN	€ EPDM	€ FKM
16	VKRDV016E	10	16	199,56	199,56
20	VKRDV020E	15	16	201,55	201,55
25	VKRDV025E	20	16	226,42	226,42
32	VKRDV032E	25	16	271,84	271,84
40	VKRDV040E	32	16	287,11	287,11
50	VKRDV050E	40	16	375,76	375,76
63	VKRDV063E	50	16	391,35	391,35

Válvula de bola REGULACIÓN
DUALBLOCK®.

M-M encolar. Asiento PTFE (teflón).
Bidireccional.

Código en FKM termina en "F"
en lugar de "E"

**VKRBEV**

D

d	Ref. EPDM	DN	PN	€ EPDM	€ FKM
20	VKRBEV020E	15	16	212,10	212,10
25	VKRBEV025E	20	16	227,95	227,95
32	VKRBEV032E	25	16	268,05	268,05
40	VKRBEV040E	32	16	286,05	286,05
50	VKRBEV050E	40	16	369,32	369,32
63	VKRBEV063E	50	16	391,05	391,05

Válvula de bola REGULACIÓN
DUALBLOCK®.

Long spigot PE100 SDR11.
Asiento PTFE (teflón). Bidireccional.

Código en FKM termina en "F"
en lugar de "E"

Para recambios de las válvulas consultar el último apartado "Recambios" de esta misma tarifa.



INDUSTRIA

Accesorios de PVC-U presión

Válvulas de bola de 3 vías



TKDIV

d	Ref. EPDM	DN	PN	€ EPDM	€ FKM
16	TKDIV016E	10	16	107,65	121,69
20	TKDIV020E	15	16	109,91	124,19
25	TKDIV025E	20	16	127,18	146,28
32	TKDIV032E	25	16	157,65	181,33
40	TKDIV040E	32	16	190,17	224,49
50	TKDIV050E	40	16	229,85	287,29
63	TKDIV063E	50	16	290,01	362,50

Válvula de bola 3 vías
DUAL BLOCK®. PASO T.
H-H-H encolar. Asiento PTFE (teflón).
Código en FKM termina en "F"
en lugar de "E"



LKDIV

d	Ref. EPDM	DN	PN	€ EPDM	€ FKM
16	LKDIV016E	10	16	118,42	133,84
20	LKDIV020E	15	16	120,87	136,59
25	LKDIV025E	20	16	139,96	160,88
32	LKDIV032E	25	16	173,47	199,46
40	LKDIV040E	32	16	209,27	246,95
50	LKDIV050E	40	16	252,82	316,00
63	LKDIV063E	50	16	318,99	398,74

Válvula de bola 3 vías
DUAL BLOCK®. PASO L.
H-H-H encolar. Asiento PTFE (teflón).
Código en FKM termina en "F"
en lugar de "E"



TKDFV

Rh	Ref. EPDM	DN	PN	€ EPDM	€ FKM
3/6"	TKDFV038E	10	16	118,42	132,44
1/2"	TKDFV012E	15	16	120,87	135,16
3/4"	TKDFV034E	20	16	139,96	158,97
1"	TKDFV100E	25	16	173,47	197,06
1 1/4"	TKDFV114E	32	16	209,27	243,52
1 1/2"	TKDFV112E	40	16	252,82	310,33
2"	TKDFV200E	50	16	318,99	391,53

Válvula de bola 3 vías
DUAL BLOCK®. PASO T.
H-H-H roscar. Asiento PTFE (teflón).
Código en FKM termina en "F"
en lugar de "E"



LKDFV

d	Ref. EPDM	DN	PN	€ EPDM	€ FKM
3/6"	LKDFV038E	10	16	129,23	144,62
1/2"	LKDFV012E	15	16	131,85	147,58
3/4"	LKDFV034E	20	16	152,60	173,59
1"	LKDFV100E	25	16	189,19	215,20
1 1/4"	LKDFV114E	32	16	228,29	265,97
1 1/2"	LKDFV112E	40	16	275,81	339,01
2"	LKDFV200E	50	16	348,03	427,75

Válvula de bola 3 vías
DUAL BLOCK®. PASO L.
H-H-H roscar. Asiento PTFE (teflón).
Código en FKM termina en "F"
en lugar de "E"



TKDDV

d	Ref. EPDM	DN	PN	€ EPDM	€ FKM
20	TKDDV020E	15	16	109,91	124,19
25	TKDDV025E	20	16	127,18	146,28
32	TKDDV032E	25	16	157,65	181,33
40	TKDDV040E	32	16	190,17	224,49
50	TKDDV050E	40	16	229,85	287,29
63	TKDDV063E	50	16	290,01	362,50

Válvula de bola 3 vías
DUAL BLOCK®. PASO T.
M-M-M encolar. Asiento PTFE (teflón).
Código en FKM termina en "F"
en lugar de "E"

Para recambios de las válvulas consultar el último apartado "Recambios" de esta misma tarifa.



INDUSTRIA

Válvulas manuales de PVC-U presión

Válvulas de 3 vías / Válvulas de mariposa



LKDDV

d	Ref. EPDM	DN	PN	€ EPDM	€ FKM
20	LKDDV020E	15	16	120,87	136,59
25	LKDDV025E	20	16	139,96	160,88
32	LKDDV032E	25	16	173,47	199,46
40	LKDDV040E	32	16	209,27	246,95
50	LKDDV050E	40	16	252,82	316,00
63	LKDDV063E	50	16	318,99	398,74

Válvula de bola 3 vías
DUAL BLOCK®. PASO L.

M-M-M encolar. Asiento PTFE (teflón).

Código en FKM termina en "F"
en lugar de "E"



SETFLOV

d DIN	d ANSI	Ref. DIN	€ DIN 2501	€ ANSI
20	½"	SETFLOV020	53,33	53,33
25	¾"	SETFLOV025	64,08	64,08
32	1"	SETFLOV032	68,54	68,54
40	1¼"	SETFLOV040	82,20	82,20
50	1½"	SETFLOV050	93,83	93,83
63	2"	SETFLOV063	101,64	101,64
75	2½"	SETFLOV075		186,98
90	3"	SETFLOV090		219,31
110	4"	SETFLOV110		264,59

Set embrizado.

Compuesto por 1 brida, 1 anillo fijación y 1 tuerca.
Para Válvulas VKD / VKR / TKD / RVU / VRU / VVU.

d. 75-90-110,
es el mismo artículo
para DIN y ANSI



FEOV/LM

d	Ref. EPDM	DN	€ EPDM	€ FKM
50	FEOVLM050E	40	146,01	268,05
63	FEOVLM063E	50	153,13	282,87
75	FEOVLM075E	65	158,76	286,28
90	FEOVLM090E	80	178,48	346,91
110	FEOVLM110E	100	205,33	425,01
125 (A1)	FEOVLM140E	125	236,49	555,19
140	FEOVLM140E	125	236,49	555,19
160	FEOVLM160E	150	291,07	798,02
200 (A1)	FEOVLM225E	200	468,27	1.124,64
225	FEOVLM225E	200	468,27	1.124,64
(B) 250 (1)	FEOVFM280E	250	1.388,35	-
280 (1)	FEOVFM280E	250	1.388,35	-
315 (1)	FEOVFM315E	300	1.725,67	-

Válvula de mariposa
"WAFER".

Con maneta.

Código en FKM termina en "F"
en lugar de "E"

(A1) A utilizar con portabridas especial
QPV FK/FE no incluido. (1) Sin maneta
(B) A utilizar con tubo D250 SDR26 (PN10)



FEOV/RM

d	Ref. EPDM	DN	€ EPDM	€ FKM
75	FEOVRM075E	65	445,74	537,47
90	FEOVRM090E	80	463,70	580,37
110	FEOVRM110E	100	479,70	642,21
125 (A1)	FEOVRM140E	125	501,62	738,88
140	FEOVRM140E	125	501,62	738,88
160	FEOVRM160E	150	541,44	924,36
200 (A1)	FEOVRM225E	200	785,75	1.307,27
225	FEOVRM225E	200	785,75	1.307,27
250	FEOVRM280E	250	1.949,83	-
280	FEOVRM280E	250	1.949,83	-
315	FEOVRM315E	300	2.192,86	-

Válvula de mariposa

"WAFER".

Con volante reductor.

Código en FKM termina en "F"
en lugar de "E"

(A1) A utilizar con portabridas especial
QPV FK/FE no incluido.

Ver portabridas especial QPV FK/FE para válvulas de mariposa en el apartado
Accesorios de PVC-U de esta misma tarifa.

Para recambios de las válvulas consultar el último apartado "Recambios" de esta misma tarifa.

FKOV/FM

G

d	Ref. EPDM	DN	€ EPDM	€ FKM
50	FKOVFM050E	40	228,85	357,58
63	FKOVFM063E	50	242,31	378,65
75	FKOVFM075E	65	269,25	420,67
90	FKOVFM090E	80	292,83	450,97
110	FKOVFM110E	100	317,46	488,00
125 (A1)	FKOVFM140E	125	421,82	652,93
140	FKOVFM140E	125	421,82	652,93
160	FKOVFM160E	150	466,68	705,64
200 (A1)	FKOVFM225E	200	603,55	915,42
225	FKOVFM225E	200	603,55	915,42
250**	FKOVFM280E	250	1.924,23	3.232,41
280**	FKOVFM280E	250	1.924,23	3.232,41
315**	FKOVFM315E	300	2.098,10	3.524,14
355**	FKOVFM355E	350	3.558,95	6.526,84
400**	FKOVFM400E	400	4.051,14	8.338,51

Válvula de mariposa industrial.
A EJE LIBRE.

Para actuar. Cuerpo en PPGR,
 eje inoxidable y disco en PVC-U.

Código en FKM termina en "F"
 en lugar de "E"

(A1) A utilizar con portabridas especial
 QPV FK/FE no incluido.

** ANSI 150 lbs bajo pedido
 al mismo precio.

FKOV/LM

G

d	Ref. EPDM	DN	€ EPDM	€ FKM
50	FKOVLM050E	40	268,91	397,64
63	FKOVLM063E	50	284,71	421,02
75	FKOVLM075E	65	316,34	467,81
90	FKOVLM090E	80	332,04	490,22
110	FKOVLM110E	100	361,23	530,61
125 (A1)	FKOVLM140E	125	480,12	710,12
140	FKOVLM140E	125	480,12	710,12
160	FKOVLM160E	150	518,30	742,65
200 (A1)	FKOVLM225E	200	670,86	963,68
225	FKOVLM225E	200	670,86	963,68

Válvula de mariposa industrial.
CON MANETA.

Cuerpo en PPGR,
 eje inoxidable y disco en PVC-U.

Código en FKM termina en "F"
 en lugar de "E"

(A1) A utilizar con portabridas especial
 QPV FK/FE no incluido.

FKOV/RM

G

d	Ref. EPDM	DN	€ EPDM	€ FKM
75	FKOVRM075E	65	767,34	918,78
90	FKOVRM090E	80	784,14	942,30
110	FKOVRM110E	100	812,19	981,60
125 (A1)	FKOVRM140E	125	931,13	1.161,08
140	FKOVRM140E	125	931,13	1.161,08
160	FKOVRM160E	150	969,26	1.193,65
200 (A1)	FKOVRM225E	200	1.223,93	1.516,75
225	FKOVRM225E	200	1.223,93	1.516,75
250**(B)	FKOVRM280E	250	2.245,09	3.542,08
280**	FKOVRM280E	250	2.245,09	3.542,08
315**	FKOVRM315E	300	2.419,01	3.843,91
355**	FKOVRM355E	350	4.386,18	7.354,10
400**	FKOVRM400E	400	4.878,34	9.165,72

Válvula de mariposa industrial.
CON VOLANTE.

Cuerpo en PPGR,
 eje inoxidable y disco
 en PVC-U.

Código en FKM termina en "F"
 en lugar de "E"

(A) A utilizar con portabridas especial
 QPV FK/FE no incluido.

(B) A utilizar con tubo D250 SDR26 (PN10)
 ** ANSI 150 lbs bajo pedido al mismo precio

FKOV/FM

G

d	Ref. EPDM	DN	€ EPDM	€ FKM
75	FKOLVFM075E	65	408,36	559,77
90	FKOLVFM090E	80	474,54	632,74
110	FKOLVFM110E	100	514,92	685,47
125 (A1)	FKOLVFM140E	125	685,47	916,54
140	FKOLVFM140E	125	685,47	916,54
160	FKOLVFM160E	150	751,65	990,61
200 (A1)	FKOLVFM225E	200	898,59	1.210,43
225	FKOLVFM225E	200	898,59	1.210,43

Válvula de mariposa industrial.
A EJE LIBRE. LUG ISO-DIN.

Para actuar. Cuerpo en PPGR,
 eje inoxidable y disco en PVC-U.

Código en FKM termina en "F"
 en lugar de "E"

Para recambios de las válvulas consultar el último apartado "Recambios" de esta misma tarifa.

**FKOV/LM**

G

d	Ref. EPDM	DN	€ EPDM	€ FKM
75	FKOLVLM075E	65	455,43	606,92
90	FKOLVLM090E	80	513,80	671,97
110	FKOLVLM110E	100	558,65	728,08
125 (A1)	FKOLVLM140E	125	743,75	973,71
140	FKOLVLM140E	125	743,75	973,71
160	FKOLVLM160E	150	803,25	1.027,59
200 (A1)	FKOLVLM225E	200	965,85	1.258,70
225	FKOLVLM225E	200	965,85	1.258,70

Válvula de mariposa industrial.
CON MANETA. LUG ISO-DIN.
Cuerpo en PPGR,
eje **inoxidable** y disco en PVC-U.

Código en FKM termina en "F"
en lugar de "E"
(A1) A utilizar con portabridas
especial QPV FK/FE no incluido.

**FKOV/RM**

G

d	Ref. EPDM	DN	€ EPDM	€ FKM
75	FKOLVRM075E	65	906,47	1.057,89
90	FKOLVRM090E	80	965,85	1.124,03
110	FKOLVRM110E	100	1.009,62	1.179,03
125 (A1)	FKOLVRM140E	125	1.194,78	1.424,69
140	FKOLVRM140E	125	1.194,78	1.424,69
160	FKOLVRM160E	150	1.254,22	1.478,56
200 (A1)	FKOLVRM225E	200	1.518,94	1.811,77
225	FKOLVRM225E	200	1.518,94	1.811,77

Válvula de mariposa industrial.
CON VOLANTE. LUG ISO-DIN.
Cuerpo en PPGR,
eje **inoxidable** y disco en PVC-U.

Código en FKM termina en "F"
en lugar de "E"
(A1) A utilizar con portabridas
especial QPV FK/FE no incluido.

**FKOV/FM**

G

d	Ref. EPDM	DN	€ EPDM	€ FKM
2½"	FKOALVFM212E	65	477,87	629,32
3"	FKOALVFM300E	80	547,45	705,64
4"	FKOALVFM400E	100	594,57	765,06
5"	FKOALVFM500E	125	790,90	1.022,00
6"	FKOALVFM600E	150	866,06	1.105,03
8"	FKOALVFM800E	200	1.045,52	1.357,37
10"	FKOALVFM810E	250	3.338,58	4.646,79
12"	FKOALVFM812E	300	3.544,92	4.970,97

Válvula de mariposa industrial.
A EJE LIBRE. LUG ANSI.
Para actuar. Cuerpo en PPGR,
eje **inoxidable** y disco en PVC-U.

Código en FKM termina en "F"
en lugar de "E"

**FKOV/LM**

G

d	Ref. EPDM	DN	€ EPDM	€ FKM
2½"	FKOALVLM212E	65	525,02	676,46
3"	FKOALVLM300E	80	586,72	744,86
4"	FKOALVLM400E	100	638,34	807,69
5"	FKOALVLM500E	125	849,21	1.079,22
6"	FKOALVLM600E	150	917,61	1.142,03
8"	FKOALVLM800E	200	1.112,79	1.405,63

Válvula de mariposa industrial.
CON MANETA. LUG ANSI.
Cuerpo en PPGR,
eje **inoxidable** y disco en PVC-U.

Código en FKM termina en "F"
en lugar de "E"

**FKOV/RM**

G

d	Ref. EPDM	DN	€ EPDM	€ FKM
2½"	FKOALVRM212E	65	975,99	1.127,43
3"	FKOALVRM300E	80	1.038,77	1.196,97
4"	FKOALVRM400E	100	1.089,26	1.258,70
5"	FKOALVRM500E	125	1.300,20	1.530,19
280**	FKOALVRM600E	150	1.368,65	1.592,99
315**	FKOALVRM800E	200	1.665,85	1.958,67
355**	FKOALVRM810E	250	3.659,51	4.956,50
400**	FKOALVRM812E	300	3.865,77	5.290,70

Válvula de mariposa industrial.
CON VOLANTE. LUG ANSI.
Cuerpo en PPGR,
eje **inoxidable** y disco en PVC-U.

Código en FKM termina en "F"
en lugar de "E"

Para recambios de las válvulas consultar el último apartado "Recambios" de esta misma tarifa.



INDUSTRIA

Válvulas manuales de PVC-U presión

Válvulas y grifos de membrana



DKDV



H

d	Ref. EPDM	DN	€ EPDM	€ FKM	€ PTFE
20	DKDV020E	15	74,40	131,98	154,49
25	DKDV025E	20	82,84	139,01	161,44
32	DKDV032E	25	101,12	158,66	182,58
40	DKDV040E	32	119,35	217,60	242,90
50	DKDV050E	40	164,35	261,14	286,44
63	DKDV063E	50	200,72	363,65	359,34
75	DKDV075E	65	240,88	436,37	431,22

Válvula de membrana DIALOCK®.
M-M encolar.

Código en FKM termina en "F" en lugar de "E"
Código en PTFE termina en "P" en lugar de "E"

DKLDV



H

d	Ref. EPDM	DN	€ EPDM	€ FKM	€ PTFE
20	DKLDV020E	15	186,64	244,19	266,73
25	DKLDV025E	20	195,09	251,25	273,65
32	DKLDV032E	25	213,35	270,87	294,82
40	DKLDV040E	32	231,58	329,80	355,12
50	DKLDV050E	40	308,63	405,42	418,19
63	DKLDV063E	50	345,03	507,93	488,98
75	DKLDV075E	65	414,02	609,53	586,78

Válvula de membrana DIALOCK®. **CON LIMITADOR DE CARRERA.**
M-M encolar.

Código en FKM termina en "F" en lugar de "E"
Código en PTFE termina en "P" en lugar de "E"

VMDV



H

d	Ref. EPDM	DN	€ EPDM	€ FKM	€ PTFE
90	VMDV090E	80	575,65	1.029,10	790,36
110	VMDV110E	100	798,80	1.568,26	1.064,19

Válvula de membrana.
M-M encolar.

Código en FKM termina en "F" en lugar de "E"
Código en PTFE termina en "P" en lugar de "E"

DKUIV



H

d	Ref. EPDM	DN	€ EPDM	€ FKM	€ PTFE
20	DKUIV020E	15	89,89	150,20	179,68
25	DKUIV025E	20	98,34	165,71	193,79
32	DKUIV032E	25	122,20	191,02	217,60
40	DKUIV040E	32	146,04	255,48	286,44
50	DKUIV050E	40	199,32	315,92	346,78
63	DKUIV063E	50	245,64	430,98	425,34

Válvula de membrana DIALOCK®.
Con enlaces H-H para encolar.

Código en FKM termina en "F" en lugar de "E"
Código en PTFE termina en "P" en lugar de "E"

DKLUIV



H

d	Ref. EPDM	DN	€ EPDM	€ FKM	€ PTFE
20	DKLUIV020E	15	202,11	262,41	291,91
25	DKLUIV025E	20	210,57	277,91	306,02
32	DKLUIV032E	25	234,40	303,26	329,82
40	DKLUIV040E	32	258,27	367,71	398,66
50	DKLUIV050E	40	343,59	460,21	491,07
63	DKLUIV063E	50	389,93	575,26	569,64

Válvula de membrana DIALOCK®. **CON LIMITADOR DE CARRERA.**
Con enlaces H-H para encolar.

Código en FKM termina en "F" en lugar de "E"
Código en PTFE termina en "P" en lugar de "E"

DKUFV



H

Rh	Ref. EPDM	DN	PN	€ EPDM	€ FKM	€ PTFE
½"	DKUFV012E	15	10	98,34	158,66	188,12
¾"	DKUFV034E	20	10	106,66	175,52	202,20
1"	DKUFV100E	25	10	130,55	197,93	226,01
1¼"	DKUFV114E	32	10	172,63	282,16	311,63
1½"	DKUFV120E	40	10	230,29	345,32	377,66
2"	DKUFV200E	50	10	275,12	460,48	453,41

Válvula de membrana DIALOCK®.
Con enlaces H-H para rosca.

Código en FKM termina en "F" en lugar de "E"
Código en PTFE termina en "P" en lugar de "E"

Para recambios de las válvulas consultar el último apartado "Recambios" de esta misma tarifa.

DKOV

H

d	Ref. EPDM	DN	PN	€ EPDM	€ FKM	€ PTFE
20	DKOV020E	15	10	123,12	180,67	203,17
25	DKOV025E	20	10	133,96	190,13	212,56
32	DKOV032E	25	10	154,37	211,91	235,78
40	DKOV040E	32	10	190,26	288,50	313,81
50	DKOV050E	40	10	238,69	335,50	360,80
63	DKOV063E	50	10	304,88	467,82	463,54
75	DKOV075E	65	10	396,36	608,19	602,61

Válvula de membrana
DIALOCK®.
Con bridas DIN.

Código en FKM termina en "F"
en lugar de "E"
Código en PTFE termina en "P"
en lugar de "E"
* DIN y ANSI 150lbs.

DKOAV

H

d	Ref. EPDM	DN	PN	€ EPDM	€ FKM	€ PTFE
1/2"	DKOAV012E	15	10	123,12	180,67	203,17
3/4"	DKOAV034E	20	10	133,96	190,13	212,56
1"	DKOAV100E	25	10	154,37	211,91	235,78
1 1/4"	DKOAV114E	32	10	190,26	288,50	313,81
1 1/2"	DKOAV120E	40	10	238,70	335,49	360,80
2"	DKOAV200E	50	10	304,88	467,82	463,54
2 1/2"	DKOAV212E	65	10	396,36	608,19	602,61

Válvula de membrana
DIALOCK®.
Con bridas ANSI 150 lbs.

Código en FKM termina en "F"
en lugar de "E"
Código en PTFE termina en "P"
en lugar de "E"

VMOV

H

d	Ref. EPDM	DN	€ EPDM	€ FKM	€ PTFE
90	VMOV090E	80	782,41	1.235,87	997,18
110	VMOV110E	100	1.040,75	1.810,22	1.306,20

Válvula de membrana
Con bridas DIN.
Bajo pedido con bridas ANSI 150 lbs.
(con el mismo precio)

Código en FKM termina en "F"
en lugar de "E"
Código en PTFE termina en "P"
en lugar de "E"



CMDV M-M encolar.
CMIV H-H encolar.

CMUIV H-H enlaces encolar.
CMFV H-H roscar.

H

d-Rh	Ref. EPDM	DN	€ EPDM	€ FKM	€ FKM
20	CMDV020E	15	73,05	103,85	109,54
16	CMIV016E	12	60,34	84,24	95,45
20	CMIV020E	15	77,19	95,45	102,49
20	CMUIV020E	15	84,24	108,13	112,32
3/8"	CMFV038E	12	60,34	84,24	95,45
1/2"	CMFV012E	15	77,19	95,45	102,49

Válvula de membrana compacta.

Código en FKM termina en "F"
en lugar de "E"
Código en PTFE termina en "P"
en lugar de "E"

RPDRV

I

Rm-d	Ref.	DN	U/	€ FKM
1/2"-16	RPDRV012016E	15	50	51,53

Grifo de pistón hidroponía.
Membrana en FKM. M espiga - M roscar.

RMRPV

I

Rm-Pm	Ref.	DN	€ EPDM
1/2"-20	RMRPV012020E	15	32,12

Grifo de membrana.
Membrana en EPDM. M espiga - M roscar.

VMFV

I

Rh	Ref.	DN	U/	€ EPDM
1/4"	VMFV014E	8	1	45,13

Grifo de membrana.
Membrana en EPDM. H-H roscar.

RMRV

I

Rm	Ref.	DN	U/	€ EPDM
1/2"	RMRV012E	15	1	32,12

Grifo de membrana.
Membrana en EPDM. M-M roscar.

Para recambios de las válvulas consultar el último apartado "Recambios" de esta misma tarifa.

**VMIV**

d	Ref.	DN	U/	€ EPDM
12	VMIV012E	8	1	42,40

Grifo de membrana.

Membrana en EPDM. H-H rosca.

**VVUIV**

d	Ref.	DN	PN	U/	€ EPDM
16	VVUIV016E	10	16	6	60,34
20	VVUIV020E	15	16	6	61,64
25	VVUIV025E	20	16	6	70,59
32	VVUIV032E	25	16	6	84,03
40	VVUIV040E	32	10	16	110,66
50	VVUIV050E	40	10	16	147,76
63	VVUIV063E	50	10	16	221,28

Válvula asiento inclinado.

Junta EPDM. H-H enlaces para encolar.

**VDDV**

d	Ref.	DN	PN	U/	€ EPDM
16	VDDV016E	10	16	6	52,72
20	VDDV020E	15	16	6	55,47
25	VDDV025E	20	16	6	61,34
32	VDDV032E	25	16	6	73,05
40	VDDV040E	32	10	16	96,26
50	VDDV050E	40	10	16	128,49
63	VDDV063E	50	10	16	186,72

Válvula asiento inclinado.

Junta EPDM. M-M encolar.

Para recambios de las válvulas consultar el último apartado "Recambios" de esta misma tarifa.



INDUSTRIA

Válvulas manuales de PVC-U presión

Válvulas de retención

**SXEIV**

d	Ref. EPDM	DN	PN	Pack	U/	€ EPDM	€ FKM
16	SXEIV016E	10	16	2	30	27,65	29,26
20	SXEIV020E	15	16	2	30	27,78	29,37
25	SXEIV025E	20	16	2	30	32,09	32,76
32	SXEIV032E	25	16	2	20	34,08	35,59
40	SXEIV040E	32	16	2	14	42,41	47,87
50	SXEIV050E	40	16	2	6	52,19	55,85
63	SXEIV063E	50	16	2	6	75,81	89,04
75	SXEIV075E	65	16	2	2	174,78	187,03
90	SXEIV090E	80	16	2	2	219,25	233,28
110	SXEIV110E	100	16	2	2	287,73	317,39

Válvula de bola anti-retorno.
Juntas en EPDM o FKM. H-H encolar.

Código en FKM termina en "F"
en lugar de "E"

**SXEIV**

Rh	Ref. EPDM	DN	PN	Pack	U/	€ EPDM	€ FKM
3/8"	SXEIV038E	10	16	2	30	29,78	Consultar
1/2"	SXEIV012E	15	16	2	30	29,89	Consultar
3/4"	SXEIV034E	20	16	2	30	35,30	Consultar
1"	SXEIV100E	25	16	2	20	39,14	Consultar
1 1/4"	SXEIV114E	32	16	2	14	47,05	Consultar
1 1/2"	SXEIV112E	40	16	2	6	56,96	Consultar
2"	SXEIV200E	50	16	2	6	89,71	Consultar
2 1/2"	SXEIV212E	65	16	2	2	199,15	211,37
3"	SXEIV300E	80	16	2	2	249,22	263,25
4"	SXEIV400E	100	16	2	2	303,15	332,82

Válvula de bola anti-retorno.
Juntas en EPDM o FKM. H-H roscar.

Código en FKM termina en "F"
en lugar de "E"

**SXEBEV**

d	Ref. EPDM	DN	PN	U/	€ EPDM	€ FKM
75	SXEBEV075E	65	16	1	204,49	213,20
90	SXEBEV090E	80	16	1	256,54	265,94
110	SXEBEV110E	100	16	1	336,65	361,83

Válvula de bola anti-retorno.
Junta EPDM o FKM.
Long spigot PE100 SDR11.

Código en FKM termina en "F"
en lugar de "E"

**VZIV**

d-Rh	Ref. EPDM	DN	PN	U/	€ EPDM
16-3/8"	VZIV016E	10	16	16	48,52
20-1/2"	VZIV020E	15	16	16	49,73
25-3/4"	VZIV025E	20	16	16	56,18
32-1"	VZIV032E	25	16	6	60,63
40-1 1/4"	VZIV040E	32	16	3	68,36
50-1 1/2"	VZIV050E	40	16	3	94,84
63-2"	VZIV063E	50	16	3	135,19

Válvula de fondo / pie.
Juntas en EPDM.
H-M encolar - H-H roscar.

Se suministra con las piezas necesarias
para convertir la válvula
roscada hembra por ambos extremos.

**SXE SSE**

d	Ref. EPDM	DN	€
16-20	HAVXE020	10-15	3,64
25	HAVXE025	20	5,33
32	HAVXE032	25	7,78
40	HAVXE040	32	15,33
50	HAVXE050	40	15,61
63	HAVXE063	50	24,99

Maneta multifunción EASYFIT
Para apretar tuercas de válvulas
SXE - SSE.

Para recambios de las válvulas consultar el último apartado "Recambios" de esta misma tarifa.

SSEIV

d	Ref. EPDM	DN	PN	Pack	U/	€ EPDM	€ FKM
16	SSEIV016E	10	16	2	30	24,22	25,62
20	SSEIV020E	15	16	2	30	24,33	25,73
25	SSEIV025E	20	16	2	30	28,14	28,73
32	SSEIV032E	25	16	2	20	29,87	31,19
40	SSEIV040E	32	16	2	14	37,18	41,97
50	SSEIV050E	40	16	2	6	45,76	48,97
63	SSEIV063E	50	16	2	6	66,44	78,04
75	SSEIV075E	65	16	-	1	153,18	163,88
90	SSEIV090E	80	16	-	1	192,18	204,44
110	SSEIV110E	100	16	-	1	252,18	278,13

Válvula de retención con muelle en INOX 316. Código en FKM termina en "F" en lugar de "E"

Juntas en EPDM o FKM. H-H encolar.

SSEFV

Rh	Ref. EPDM	DN	PN	Pack	U/	€ EPDM	€ FKM
3/8"	SSEFV038E	10	16	2	30	26,09	27,50
1/2"	SSEFV012E	15	16	2	30	26,21	27,61
3/4"	SSEFV034E	20	16	2	30	30,93	31,56
1"	SSEFV100E	25	16	2	20	34,30	35,64
1 1/4"	SSEFV114E	32	16	2	14	41,24	46,01
1 1/2"	SSEFV112E	40	16	2	6	49,90	53,11
2"	SSEFV200E	50	16	2	6	78,62	90,24
2 1/2"	SSEFV212E	65	16	-	1	174,53	185,25
3"	SSEFV300E	80	16	-	1	218,44	230,71
4"	SSEFV400E	100	16	-	1	265,67	291,68

Válvula de retención con muelle en INOX 316. Código en FKM termina en "F" en lugar de "E"

Juntas en EPDM o FKM. H-H roscar.

SSEIV

d	Ref. EPDM	DN	PN	Pack	U/	€ EPDM	€ FKM
16	SSEIV016EH	10	16	2	30	72,37	73,80
20	SSEIV020EH	15	16	2	30	72,49	73,87
25	SSEIV025EH	20	16	2	30	78,79	79,39
32	SSEIV032EH	25	16	2	20	77,57	78,91

Válvula de retención con muelle en HASTELLOY. Código en FKM termina en "F" en lugar de "E"

Juntas en EPDM o FKM. H-H encolar.

SSEFV

Rh	Ref. EPDM	DN	PN	Pack	U/	€ EPDM	€ FKM
3/8"	SSEFV038EH	10	16	2	30	74,47	75,90
1/2"	SSEFV012EH	15	16	2	30	74,64	76,00
3/4"	SSEFV034EH	20	16	2	30	81,99	82,62
1"	SSEFV100EH	25	16	2	20	82,63	83,96

Válvula de retención con muelle en HASTELLOY. Código en FKM termina en "F" en lugar de "E"

Juntas en EPDM o FKM. H-H roscar.

SSEIV

d	Ref. EPDM	DN	PN	Pack	U/	€ EPDM	€ FKM
40	SSEIV040E0P	32	16	2	14	52,48	57,25
50	SSEIV050E0P	40	16	2	6	61,88	65,08
63	SSEIV063E0P	50	16	2	6	88,38	99,96
75	SSEIV075E0P	65	16	-	1	194,71	194,71
90	SSEIV090E0P	80	16	-	1	236,57	239,76
110	SSEIV110E0P	100	16	-	1	309,99	309,99

Válvula de retención con muelle en INOX recubierto de PTFE.. Código en FKM termina en "F" en lugar de "E"

Juntas en EPDM o FKM. H-H encolar.

SSEFV

Rh	Ref. EPDM	DN	PN	Pack	U/	€ EPDM	€ FKM
1 1/4"	SSEFV114E0P	32	16	2	14	57,10	61,90
1 1/2"	SSEFV112E0P	40	16	2	6	66,61	69,82
2"	SSEFV200E0P	50	16	2	6	102,28	113,89
2 1/2"	SSEFV212E0P	65	16	1	1	219,10	219,10
3"	SSEFV300E0P	80	16	1	1	269,73	269,73
4"	SSEFV400E0P	100	16	-	1	325,43	325,43

Válvula de retención con muelle en INOX recubierto de PTFE.. Código en FKM termina en "F" en lugar de "E"

Juntas en EPDM o FKM. H-H roscar.

Para recambios de las válvulas consultar el último apartado "Recambios" de esta misma tarifa.

**SSEBEV**

d	Ref. EPDM	DN	PN	Pack	U/	€ EPDM	€ FKM
75	SSEBEV075E	65	16	-	1	179,20	186,85
90	SSEBEV090E	80	16	-	1	224,83	233,05
110	SSEBEV110E	100	16	-	1	295,00	317,07

Válvula de retención
con muelle en INOX 316.

Juntas en EPDM o FKM.

Long spigot PE100 SDR11.

Código en FKM termina en "F"
en lugar de "E"

**SSEBEV**

d	Ref. EPDM	DN	PN	Pack	U/	€ EPDM	€ FKM
75	SSEBEV075E0P	65	16	-	1	222,25	221,99
90	SSEBEV090E0P	80	16	-	1	276,76	273,31
110	SSEBEV110E0P	100	16	-	1	349,12	353,39

Válvula de retención con muelle
en INOX recubierto PTFE.

Juntas en EPDM o FKM.

Long spigot PE100 SDR11.

Código en FKM termina en "F"
en lugar de "E"

**VRUIV**

d	Ref. EPDM	DN	U/	€ EPDM	€ FKM
16	VRUIV016E	10	20	48,75	58,47
20	VRUIV020E	15	20	51,98	62,41
25	VRUIV025E	20	10	60,34	72,37
32	VRUIV032E	25	10	72,12	86,58
40	VRUIV040E	32	6	90,01	108,02
50	VRUIV050E	40	6	127,95	153,52
63	VRUIV063E	50	6	186,27	223,51

Válvula anti-retorno inclinada.

Juntas en EPDM o FKM.

H-H enlaces para encolar.

Código en FKM termina en "F"
en lugar de "E"

**VRUFV**

d	Ref. EPDM	DN	PN	U/	€ EPDM
3/8"	VRUFV038E	10	16	20	69,94
1/2"	VRUFV012E	15	16	20	72,55
3/4"	VRUFV034E	20	16	10	84,03
1"	VRUFV100E	25	16	10	103,52
1 1/4"	VRUFV114E	32	16	6	131,59
1 1/2"	VRUFV112E	40	16	6	173,30
2"	VRUFV200E	50	16	6	229,24

Válvula anti-retorno inclinada.

Juntas en EPDM. H-H enlaces para rosca.

**VRIV**

d	Ref. EPDM	DN	PN	U/	€ EPDM
75	VRIV075E	65	10	2	278,02
90	VRIV090E	80	6	1	360,83
110	VRIV110E	100	6	1	634,61

Válvula anti-retorno inclinada.

Juntas en EPDM. H-H enlaces para rosca.

**VRFV**

Rh	Ref. EPDM	DN	PN	U/	€ EPDM
2 1/2"	VRFV212E	65	10	2	387,44
3"	VRFV300E	80	6	1	494,25
4"	VRFV400E	100	6	1	651,49

Válvula anti-retorno inclinada.

Juntas en EPDM. H-H enlaces para rosca.

**VRDV**

d	Ref. EPDM	DN	PN	U/	€ EPDM
16	VRDV016E	10	16	20	42,40
20	VRDV020E	15	16	20	45,13
25	VRDV025E	20	16	20	52,43
32	VRDV032E	25	16	20	62,71
40	VRDV040E	32	16	12	78,20
50	VRDV050E	40	16	6	111,25
63	VRDV063E	50	16	6	161,44

Válvula anti-retorno inclinada.

Junta en EPDM. M-M encolar.

**SZIV/SZRV***

d	Ref. encolar	Ref. rosca	€ encolar	€ rosca
16	SZIV016		17,67	-
20	SZIV020	SZRV034	18,72	5,87
25	SZIV025	SZRV100	19,74	5,92
32	SZIV032	SZRV114	21,04	6,18
40	SZIV040	SZRV112	39,76	8,59
50	SZIV050	SZRV200	40,90	9,52
63	SZIV063		42,20	-

Tamiz filtro seguridad.

Para válvulas de fondo/pie. Encolar M / Roscar M.

Para recambios de las válvulas consultar el último apartado "Recambios" de esta misma tarifa.



INDUSTRIA

Válvulas manuales de PVC-U presión

Conectores

**CVDE**

d	Ref.	Para válvulas	€
20	CVDE11020		5,33
25	CVDE11025		5,45
32	CVDE11032	VKD-VKR-TKD	5,54
40	CVDE11040	VEE-VXE-SXE	8,64
50	CVDE11050	SSE-RV-VV-VR	10,27
63	CVDE11063		14,59
75	CVDE11075	VKD-VEE-VXE-SX/SSE	41,01
90	CVDE11090	VKD	53,30
90	CVDE11090VXE	VEE-VXE-SXE-SSE	53,30
110	CVDE11110	VKD	61,99
110	CVDE11110VXE	VEE-VXE-SXE-SSE	61,99

Conector final en PE100 SDR11.
Para soldadura a testa o electrofusión.

**Q/BBE-L**

d	Ref.	Para válvulas	€
20	QBBEL11020	DK	7,40
25	QBBEL11025	DK	8,70
32	QBBEL11032	DK	11,06
40	QBBEL11040	DK	14,12
50	QBBEL11050	DK	14,57
63	QBBEL11063	DK	21,24

Conector final en PE100 SDR11.
Para soldadura a testa o electrofusión.

Para recambios de las válvulas consultar el último apartado "Recambios" de esta misma tarifa.



INDUSTRIA

Válvulas manuales de PVC-U presión

Filtros inclinados



RVUIV

d	Ref.	DN	PN	U/	€ EPDM
16	RVUIV016E	10	16	20	40,48
20	RVUIV020E	15	16	20	40,48
25	RVUIV025E	20	16	10	46,84
32	RVUIV032E	25	16	10	63,81
40	RVUIV040E	32	16	6	80,76
50	RVUIV050E	40	16	6	105,73
63	RVUIV063E	50	16	6	137,64

Filtro inclinado PVC-U gris.

Juntas en EPDM. H-H enlaces para encolar.



RVUIT

d	Ref.	DN	PN	U/	€ EPDM
16	RVUIT016E	10	16	20	40,48
20	RVUIT020E	15	16	20	40,48
25	RVUIT025E	20	16	10	46,84
32	RVUIT032E	25	16	10	63,81
40	RVUIT040E	32	10	6	80,76
50	RVUIT050E	40	10	6	105,73
63	RVUIT063E	50	10	6	137,64

Filtro inclinado PVC transparente.

Juntas en EPDM. H-H enlaces para encolar.



RVIV

d	Ref.	DN	PN	U/	€ EPDM
75	RVIV075E	65	10	2	178,99
90	RVIV090E	80	6	1	213,42
110	RVIV110E	100	6	1	502,65

Filtro inclinado PVC-U gris.

H-H encolar (sin enlaces en los extremos).



RVIT

d	Ref.	DN	PN	U/	€ EPDM
75	RVIT075E	65	6	2	189,84
90	RVIT090E	80	4	1	213,42
110	RVIT110E	100	4	1	502,65

Filtro inclinado PVC-U transparente.

H-H encolar (sin enlaces en los extremos).



RVUFV

Rh	Ref.	DN	PN	U/	€ EPDM
3/8"	RVUFV038E	10	16	20	51,98
1/2"	RVUFV012E	15	16	20	57,75
3/4"	RVUFV034E	20	16	10	68,55
1"	RVUFV100E	25	16	10	90,71
1 1/4"	RVUFV114E	32	16	6	115,08
1 1/2"	RVUFV112E	40	16	6	142,68
2"	RVUFV200E	50	16	6	175,65

Filtro inclinado PVC-U gris.

Juntas en EPDM. H-H enlaces para roscar.



RVFV

Rh	Ref.	DN	PN	U/	€ EPDM
2 1/2"	RVFV212E	65	10	2	286,44
3"	RVFV300E	80	6	1	358,16
4"	RVFV400E	100	6	1	536,29

Filtro inclinado PVC-U gris.

H-H roscar (sin enlaces en los extremos).

Para recambios de las válvulas consultar el último apartado "Recambios" de esta misma tarifa.

RVUFT

Rh	Ref.	DN	PN	U/	€ EPDM
3/8"	RVUFT038E	10	16	20	51,98
1/2"	RVUFT012E	15	16	20	54,46
3/4"	RVUFT034E	20	16	10	72,01
1"	RVUFT100E	25	16	10	96,05
1 1/4"	RVUFT114E	32	10	6	120,16
1 1/2"	RVUFT112E	40	10	6	146,76
2"	RVUFT200E	50	10	6	189,38

Filtro inclinado **PVC transparente**.

Junta en EPDM. H-H enlases para roscar.

RVDV

d	Ref.	DN	PN	U/	€ EPDM
16	RVDV016E	10	16	20	35,15
20	RVDV020E	15	16	20	35,15
25	RVDV025E	20	16	20	40,66
32	RVDV032E	25	16	20	55,47
40	RVDV040E	32	16	12	87,63
50	RVDV050E	40	16	6	91,97
63	RVDV063E	50	16	6	119,70

Filtro inclinado **PVC gris**.

Junta en EPDM. M-M encolar.

RVDT

d	Ref.	DN	PN	U/	€ EPDM
16	RVDT016E	10	10	20	36,51
20	RVDT020E	15	10	20	36,51
25	RVDT025E	20	10	20	42,32
32	RVDT032E	25	10	20	57,69
40	RVDT040E	32	10	12	73,06
50	RVDT050E	40	10	6	95,64
63	RVDT063E	50	10	6	124,49

Filtro inclinado **PVC transparente**.

Junta en EPDM. M-M encolar.

RVFT

Rh	Ref.	DN	PN	U/	€ EPDM
2 1/2"	RVFT212E	65	6	2	294,86
3"	RVFT300E	80	4	1	379,09
4"	RVFT400E	100	4	1	544,70

Filtro inclinado **PVC-U transparente**.

H-H roscar (sin enlases en los extremos).

VAIV

d-Rh	Ref.	DN	PN	U/	€ EPDM
20-1/2"	VAIV020E	15	16	16	49,73
25-3/4"	VAIV025E	20	16	20	56,24
32-1"	VAIV032E	25	16	6	60,94
40-1 1/4"	VAIV040E	32	16	3	66,19
50-1 1/2"	VAIV050E	40	16	3	95,11
63-2"	VAIV063E	50	16	3	139,12

Válvula de purga bola ventosa.

Junta en EPDM.

H-M encolar / H-H roscar.

Se suministra con las piezas necesarias para convertir la válvula roscada hembra por ambos extremos.

MANGUITO

d	Ref.	DN	€ PVC-U
16	ENDIV016	10	5,76
20	ENDIV020	15	5,76
25	ENDIV025	20	6,91
32	ENDIV032	25	7,87
40	ENDIV040	32	9,43
50	ENDIV050	40	10,87
63	ENDIV063	50	14,25
75	ENDIV075	65	25,87
90	ENDIV090	80	32,02
90	ENDIV090VXE *	80	32,02
110	ENDIV110	100	54,10
110	ENDIV110VXE *	100	54,10

Manguito **encolar H**.

Para válvulas VKD-VKR-TKD-VXE-VEE-SXE-SSE-RV-VR-VV.

* Para válvulas VEE-VXE-SXE-SSE.

Para recambios de las válvulas consultar el último apartado "Recambios" de esta misma tarifa.



INDUSTRIA

Válvulas manuales de PVC-U presión

Accesorios para válvulas manuales

**MANGUITO**

d	Ref.	DN	€ PVC-U
16	ENDDV016	10	5,76
20	ENDDV020	15	5,76
25	ENDDV025	20	6,91
32	ENDDV032	25	7,87
40	ENDDV040	32	9,43
50	ENDDV050	40	10,87
63	ENDDV063	50	14,25
75	ENDDV075	65	25,12
90	ENDDV090	80	31,05
110	ENDDV110	100	54,10

Manguito encolar M.

Para válvulas VKD-VKR-TKD-VXE-VEE-SXE-SSE-RV-VR-VV.

**PSKD**

d	Ref.	DN	Ø tubo	€
16-20	PSKD020	10-15	25	40,17
25	PSKD025	20	25	41,07
32	PSKD032	25	25	42,12
40	PSKD040	32	32	42,59
50	PSKD050	40	32	44,30
63	PSKD063	50	32	48,88

Eje de extensión.

Tubo no incluido.

Para válvulas de bola VKD-VKR-TKD.

**Power Quick/CP**

d	Ref.	DN	ISO	Cuadrado	€
16-20	PQCP020	10-15	F03-04+	11	32,67
25	PQCP025	20	F03-05+	11	34,70
25	PQCP025F04	20	F04	11	34,70
32	PQCP032	25	F03-05+	11	34,70
32	PQCP032F04	25	F04	11	34,70
40	PQCP040	32	F05-07+	14	39,65
50	PQCP050	40	F05-07+	14	39,65
63	PQCP063	50	F05-07+	14	42,14

Kit de actuación neumático.

+ Para final de carrera tipo MSKD.

Para válvulas VKD-VKR-TKD.

**MANGUITO**

d	Ref.	DN	€ PVC-U
3/8"	ENDFV038	10	5,76
1/2"	ENDFV012	15	5,76
3/4"	ENDFV034	20	6,91
1"	ENDFV100	25	7,87
1 1/4"	ENDFV114	32	9,43
1 1/2"	ENDFV112	40	10,87
2"	ENDFV200	50	14,25
2 1/2"	ENDFV212	65	25,12
3"	ENDFV300	80	31,05
3"	ENDFV300VXE *	80	31,05
4"	ENDFV400	100	54,10
4"	ENDFV400VXE *	100	54,10

Manguito roscar H.

Para válvulas VKD-VKR-TKD-VXE-VEE-SXE-SSE-RV-VR-VV.

* Para válvulas VEE-VXE-SXE-SSE.

**VKD**

d	Ref.	DN	€
75-110	AKVKD075110	65-100	62,80

Kit de actuación.

Adaptador para actuador.

Para válvulas de mariposa FK.

**FK**

d	Ref.	DN	€
50-160	FKADA160	40-150	22,48
225	FKADA225	200	27,36

Kit de actuación.

Adaptador para actuador.

Para válvulas de mariposa FK.

**Power Quick/CE**

d	Ref.	DN	ISO	Cuadrado	€
16-20	PQCE020	10-15	F03-04	14	32,67
25	PQCE025	20	F03-05	14	34,70
25	PQCE025F04	20	F04	14	34,70
32	PQCE032	25	F03-05	14	34,70
32	PQCE032F04	25	F04	14	34,70
40	PQCE040	32	F05-07	14	39,65
50	PQCE050	40	F05-07	14	39,65
63	PQCE063	50	F05-07	14	42,14

Kit de actuación eléctrico.

Para válvulas VKD-VKR-TKD.

Bajo pedido disponemos también de otras medidas y/o estándares, como encolar BS, ASTM, JIS; y roscar NPT y JIS para todas las válvulas.

Power Quick

I

d	Ref.	DN	€
75	PQE090	65	116,62
90	PQE090	80	116,62
110	PQE110	100	128,27

Adaptador para actuador eléctrico y neumático.
 Para válvulas de bola VXE.

SOPORTE*

D

d	Ref.	DN	€
16-20	PQCECP020D	10-15	84,92
25	PQCECP025D	20	84,92
32	PQCECP032D	25	84,92
40	PQCECP040D	32	88,11
50	PQCECP050D	40	88,11
63	PQCECP063D	50	88,11

Kit de actuación eléctrico y neumático.
 Para válvulas VKD-VKR-TKD.

LS QUICK KIT

H

d	Ref.	DN	€
16-20	LSQKIT20	10-15	62,42
25	LSQKIT25	20	66,06
32	LSQKIT32	25	66,06
40	LSQKIT40	32	75,53
50	LSQKIT50	40	75,53
63	LSQKIT63	50	80,25

Accesorios de conexión para final de carrera LSQT.
 Para válvulas VKD-TKD.

LS QUICK KIT

H

d	Ref.	DN	€
50	LSQKITFK5063	40	110,66
63	LSQKITFK5063	50	110,66
75	LSQKITFK75160	65	149,00
90	LSQKITFK75160	80	149,00
110	LSQKITFK75160	100	149,00
140	LSQKITFK75160	125	149,00
160	LSQKITFK75160	150	149,00
225	LSQKIT225	200	159,05

Accesorios de conexión para final de carrera LSQT.
 Para válvulas FK.

LS QUICK KIT

H

d	Ref.	DN	€
75	LSQKIT75160	65	149,00
90	LSQKIT75160	80	149,00
110	LSQKIT75160	100	149,00

Accesorios de conexión para final de carrera LSQT.
 Para válvulas VKD.

FINALES DE CARRERA

H

d	Ref.	DN	€
Todos	LSQTMEC	Todos	192,22

Finales de carrera ELECTROMECAÑICOS IP67.
 Para válvulas VKD-TKD-FK.

d	Ref.	DN	€
Todos	LSQTPNP	Todos	330,87

Finales de carrera Inductivos PNP (3 hilos).
 Para válvulas VKD-TKD-FK.

PMKD

H

d	Ref.	DN	€
16-32	PMKD1	10-25	9,79
40-63	PMKD2	32-50	10,67

Pletinas de sujeción.
 Para válvulas de bola VKD-VKR.

PMKD KIT

H

d	Ref.	DN	€
16-32	KITPMKD1	10-25	12,16
40-63	KITPMKD2	32-50	12,82

Pletinas de sujeción con tornillos e insertos.
 Para válvulas de bola VKD-VKR.



INSERTOS

H

d	Ref.	DN	€
16-32	SINSM04X	10-25	94,52
40-63	SINSM06X	32-50	104,51

Insertos roscados en **acero inoxidable**.
 20 piezas. Para válvulas de bola VKD-VKR.



LCE

C

d	Ref.	DN	€
16-20	LCE020	10-15	45,28
25	LCE025	20	45,49
32	LCE032	25	48,40
40	LCE040	32-65-80-110 (VEE)	49,94
50-72-110	LCE050	40	51,70
63-75-110	LCE063	50-65-80-110(VXE y SSE)	66,68

Tapón + Disco para VEE, VXE, SXE y SSE. + Para final de carrera tipo MSKD.
 Tapón transparente y disco en PVC blanco.



PSE

H

d	Ref.	DN	Ø tubo	€
75	PSE090	65	63	65,64
90	PSE090	80	63	65,64
110	PSE110	100	63	65,64

Eje de extensión para válvula de bola VEE-VXE.



PMDK KIT

H

d	Ref.	DN	€
20-32	KITPMDK1	15-25	22,00
40-75	KITPMDK2	32-65	24,72

Para válvula de membrana DK.
 Paletinas de sujeción con tornillos e insertos.



SHKD

H

d	Ref.	DN	€
16-20	SHKD020	10-15	18,47
25-32	SHKD032	20-25	20,63
40-50	SHKD050	32-40	23,92
63	SHKD063	50	25,60

Kit de seguridad.
 Para válvula VKD (maneta no incluida).



LSE

C

d	Ref.	DN	A	B	€
16-20	LSE020	10-15	10	500	152,60
25	LSE025	20	10	500	152,60
32	LSE032	25	10	500	152,60
40	LSE040	32	10	500	152,60
50	LSE050	40	10	400	152,60
63	LSE063	50	10	400	152,60

Etiquetas para VEE y VXE.
 Etiquetas blancas troqueladas.

A = Número de hojas
 B = Total etiquetas



PMDK

H

d	Ref.	DN	€
20-32	PMDK1	15-25	17,02
40-75	PMDK2	32-65	19,75

Para válvula de membrana DK.
 Paletinas de sujeción.



ZPL

H

d	Ref.	DN	€
16-20	ZPL2415002	12-15	15,05

Plato separador para válvulas de membrana CM

Bajo pedido disponemos también de otras medidas y/o estándares, como encolar BS, ASTM, JIS; y roscar NPT y JIS para todas las válvulas.

Válvulas de solenoide

Válvulas de bola 2 y 3 vías

Válvulas de mariposa

Actuadores y accesorios

Válvulas de membrana

Accesorios válvulas de membrana

Válvulas de control de presión

Válvulas motorizadas PVC-U presión

INDUSTRIA





Válvulas motorizadas

Motorizando nuestra válvula industrial conseguimos que nuestras válvulas (con el par más bajo del mercado siendo estanca) puedan trabajar con un número de aperturas y cierres muy por encima de la media.

NO TODAS LAS VÁLVULAS MOTORIZADAS DEL MERCADO SON IGUALES O SEMEJANTES.

En estos artículos, donde el precio del actuador es más elevado que el de la válvula, es donde más énfasis hay que tener en colocar la mejor válvula del mercado. El precio de la válvula no se apreciará porque quedará absorbido por el precio del actuador. Una buena válvula hará que alargue su uso, su mantenimiento, su seguridad y su durabilidad.





INDUSTRIA

Válvulas motorizadas de PVC-U presión

Válvulas de solenoide



Serie:	Modelo pequeño S1	1	2	3	4	5	6	7
	Modelo grande S2							
Vías:	Dos vías	2						
Conexión:	Encolar I							
	Roscar F							
DN:	Modelo pequeño	4-6-8						
	Modelo grande	8-10-15						
Diámetro:	Modelo pequeño	10-12-16-1/4"-3/8"						
	Modelo grande	16-20-3/8"-1/2"						
Juntas:		EPDM-FKM						
Voltaje:		12V-24V-48V-110V-230V						
Corriente:		AC-DC						

Válvula de bola maneta azul.

H-H encolar. Junta EPDM - Asiento PE. Bidireccional.



S12-S22

d	Modelo encolar	Rh	Ref.	DN	€ EPDM	€ FKM
10	S12IV	1/4"	S12FV	4-6-8-10	267,01	266,06
12	S12IV	3/8"	S12FV	4-6-8-10	267,01	266,06
16	S12IV		S22FV	4-6-8-10	267,01	266,06
16	S22IV	3/8"	S22FV	8-10-15	339,94	345,86
20	S22IV	1/2"	S22IV	8-10-15	339,94	345,86

Resúmen
válvulas de solenoide 2 vías.

Voltaje estándar

24 ó 230 V AC 50/60 Hz, 24 V DC

Bajo pedido:
48, 110 V AC 50/60 Hz y 12, 48 V DC

Precio extra

voltaje no estándar: 19,58 €/Un.

S12IV



d	Ref.	DN	Voltaje	Corriente	€ EPDM
16	S12I0416E2A	04	24 V*	Alterna	267,02
16	S12I0616E2A	06	24 V*	Alterna	267,02
16	S12I0816E2A	08	24 V*	Alterna	267,02
16	S12I0416E2C	04	24 V*	Continua	267,01
16	S12I0616E2C	06	24 V*	Continua	267,01
16	S12I0816E2C	08	24 V*	Continua	267,01
16	S12I0416E5A	04	230 V*	Alterna	267,02
16	S12I0616E5A	06	230 V*	Alterna	267,02
16	S12I0816E5A	08	230 V*	Alterna	267,02

Válvula de solenoide 2 vías **ENCOLAR**. Modelo pequeño.

Juntas EPDM. H-H encolar.

* Voltaje estándar. Disponibles otras conexiones para encolar: BS y ASTM
Disponibles también en diámetro exterior Ø 10 y 12 mm. al mismo precio que las de Ø 16 mm.

S12IV



d	Ref.	DN	Voltaje	Corriente	€ F
16	S12I0416F2A	04	24 V*	Alterna	282,02
16	S12I0616F2A	06	24 V*	Alterna	282,02
16	S12I0816F2A	08	24 V*	Alterna	282,02
16	S12I1016F2A	10	24 V*	Alterna	282,02
16	S12I0416F2C	04	24 V*	Continua	282,02
16	S12I0616F2C	06	24 V*	Continua	282,02
16	S12I0816F2C	08	24 V*	Continua	282,02
16	S12I0416F5A	04	230 V*	Alterna	282,02
16	S12I0616F5A	06	230 V*	Alterna	282,02
16	S12I0816F5A	08	230 V*	Alterna	282,02
16	S12I1016F5A	10	230 V*	Alterna	282,02

Válvula de solenoide 2 vías **ENCOLAR**. Modelo pequeño.

Juntas FKM. H-H encolar.

* Voltaje estándar. Disponibles otras conexiones para encolar: BS y ASTM
Disponibles también en diámetro exterior Ø 10 y 12 mm. al mismo precio que las de Ø 16 mm.

Marcadas en amarillo los modelos estándar

Para recambios de las válvulas consultar el último apartado "Recambios" de esta misma tarifa.



S12FV

J

Rh	Ref.	DN	Voltaje	Corriente	€ EPDM
3/8"	S12F0438E2A	04	24 V*	Alterna	267,02
3/8"	S12F0638E2A	06	24 V*	Alterna	267,02
3/8"	S12F0838E2A	08	24 V*	Alterna	267,02
3/8"	S12F0438E2C	04	24 V*	Continua	267,01
3/8"	S12F0638E2C	06	24 V*	Continua	267,01
3/8"	S12F0838E2C	08	24 V*	Continua	267,01
3/8"	S12F0438E5A	04	230 V*	Alterna	267,02
3/8"	S12F0638E5A	06	230 V*	Alterna	267,02
3/8"	S12F0838E5A	08	230 V*	Alterna	267,02

Válvula de solenoide 2 vías **ROSCAR**. Modelo pequeño.

Juntas EPDM. H-H roscar.

* Voltaje estándar. Disponibles otras conexiones para encolar: NPT

Disponibles también en diámetro exterior Ø 1/4" al mismo precio que las de diámetro exterior Ø 3/8".



S12FV

J

d	Ref.	DN	Voltaje	Corriente	€ F
3/8"	S12F0438F2A	04	24 V*	Alterna	282,02
3/8"	S12F0638F2A	06	24 V*	Alterna	282,02
3/8"	S12F0838F2A	08	24 V*	Alterna	282,02
3/8"	S12F1038F2A	10	24 V*	Alterna	282,02
3/8"	S12F0438F2C	04	24 V*	Continua	282,02
3/8"	S12F0638F2C	06	24 V*	Continua	282,02
3/8"	S12F0838F2C	08	24 V*	Continua	246,36
3/8"	S12F0438F5A	04	230 V*	Alterna	282,02
3/8"	S12F0638F5A	06	230 V*	Alterna	282,02
3/8"	S12F0838F5A	08	230 V*	Alterna	282,02
3/8"	S12F1038F5A	10	230 V*	Alterna	282,02

Válvula de solenoide 2 vías **ROSCAR**. Modelo pequeño.

Juntas FKM. H-H roscar.

* Voltaje estándar. Disponibles otras conexiones para encolar: NPT

Disponibles también en diámetro exterior Ø 1/4" al mismo precio que las de diámetro exterior Ø 3/8".

Marcadas en amarillo los modelos estándar



S22IV

J

d	Ref.	DN	Voltaje	Corriente	€ EPDM
20	S22I0820E2A	08	24 V*	Alterna	339,94
20	S22I1020E2A	10	24 V*	Alterna	339,94
20	S22I1520E2A	15	24 V*	Alterna	339,94
20	S22I0820E2C	08	24 V*	Continua	339,94
20	S22I1020E2C	10	24 V*	Continua	339,94
20	S22I1520E2C	15	24 V*	Continua	339,94
20	S22I0820E5A	08	230 V*	Alterna	339,94
20	S22I1020E5A	10	230 V*	Alterna	339,94
20	S22I1520E5A	15	230 V*	Alterna	339,94

Válvula de solenoide 2 vías **ENCOLAR**. Modelo grande.

Juntas EPDM. H-H encolar.

* Voltaje estándar. Disponibles otras conexiones para encolar: BS y ASTM

Disponibles también en diámetro exterior Ø 16 mm. al mismo precio que las de Ø 20 mm.



S22IV

J

d	Ref.	DN	Voltaje	Corriente	€ FKM
20	S22I0820F2A	08	24 V*	Alterna	358,40
20	S22I1020F2A	10	24 V*	Alterna	358,40
20	S22I1520F2A	15	24 V*	Alterna	358,40
20	S22I0820F2C	08	24 V*	Continua	358,39
20	S22I1020F2C	10	24 V*	Continua	358,39
20	S22I1520F2C	15	24 V*	Continua	358,39
20	S22I0820F5A	08	230 V*	Alterna	358,40
20	S22I1020F5A	10	230 V*	Alterna	358,40
20	S22I1520F5A	15	230 V*	Alterna	358,40

Válvula de solenoide 2 vías **ENCOLAR**. Modelo grande.

Juntas FKM. H-H encolar.

* Voltaje estándar. Disponibles otras conexiones para encolar: BS y ASTM

Disponibles también en diámetro exterior Ø 16 mm. al mismo precio que las de Ø 20 mm.

Marcadas en amarillo los modelos estándar

Para recambios de las válvulas consultar el último apartado "Recambios" de esta misma tarifa.

S22FV

J

Rh	Ref.	DN	Voltaje	Corriente	€ EPDM
1/2"	S22F0812E2A	08	24 V*	Alterna	339,94
1/2"	S22F1012E2A	10	24 V*	Alterna	339,94
1/2"	S22F1512E2A	15	24 V*	Alterna	339,94
1/2"	S22F0812E2C	08	24 V*	Continua	339,94
1/2"	S22F1012E2C	10	24 V*	Continua	339,94
1/2"	S22F1512E2C	15	24 V*	Continua	296,95
1/2"	S22F0812E5A	08	230 V*	Alterna	339,94
1/2"	S22F1012E5A	10	230 V*	Alterna	339,94
1/2"	S22F1512E5A	15	230 V*	Alterna	339,94

 Válvula de solenoide 2 vías **ROSCAR**. Modelo grande.

Juntas EPDM. H-H rosca.

* Voltaje estándar. Disponibles otras conexiones para encolar: NPT.

Disponibles también en diámetro exterior Ø 3/8" al mismo precio que las de diámetro exterior Ø 1/2".

S22FV

J

Rh	Ref.	DN	Voltaje	Corriente	€ FKM
1/2"	S22F0812F2A	08	24 V*	Alterna	358,40
1/2"	S22F1012F2A	10	24 V*	Alterna	358,40
1/2"	S22F1512F2A	15	24 V*	Alterna	358,40
1/2"	S22F0812F2C	08	24 V*	Continua	358,39
1/2"	S22F1012F2C	10	24 V*	Continua	358,39
1/2"	S22F1512F2C	15	24 V*	Continua	358,39
1/2"	S22F0812F5A	08	230 V*	Alterna	358,40
1/2"	S22F1012F5A	10	230 V*	Alterna	358,40
1/2"	S22F1512F5A	15	230 V*	Alterna	358,40

 Válvula de solenoide 2 vías **ROSCAR**. Modelo grande.

Juntas FKM. H-H rosca.

* Voltaje estándar. Disponibles otras conexiones para encolar: NPT.

Disponibles también en diámetro exterior Ø 3/8" al mismo precio que las de diámetro exterior Ø 1/2".

Marcadas en amarillo los modelos estándar



INDUSTRIA

Válvulas motorizadas de PVC-U presión

Válvulas de bola actuadas



K

VKDIV/CE

encolar.

VKDFV/CE

roscar.

ACTUACIÓN ELÉCTRICA

ACTUACIÓN ELÉCTRICA CON BLOQUEO DE SEGURIDAD

d-Rh	24-240 V AC/DC €		24-240 V AC/DC €		24-240 V AC/DC €		24-240 V AC/DC €	
	Ref.	EPDM	Ref.	FKM	Ref.	EPDM	Ref.	FKM
16	VKVE016E2D	714,70	VKVE016F2D	724,77	VKVE016E2BD	1.348,25	VKVE016F2BD	1.358,33
20	VKVE020E2D	716,59	VKVE020F2D	726,27	VKVE020E2BD	1.350,13	VKVE020F2BD	1.359,83
25	VKVE025E2D	728,88	VKVE025F2D	741,33	VKVE025E2BD	1.362,46	VKVE025F2BD	1.374,87
32	VKVE032E2D	743,30	VKVE032F2D	758,46	VKVE032E2BD	1.376,83	VKVE032F2BD	1.392,03
40	VKVE040E2D	769,33	VKVE040F2D	785,88	VKVE040E2BD	1.402,89	VKVE040F2BD	1.419,43
50	VKVE050E2D	795,51	VKVE050F2D	816,16	VKVE050E2BD	1.429,04	VKVE050F2BD	1.449,73
63	VKVE063E2D	828,15	VKVE063F2D	868,98	VKVE063E2BD	1.461,70	VKVE063F2BD	1.502,54
75	VKVE075E2D	1.325,92	VKVE075F2D	1.407,92	VKVE075E2BD	1.959,48	VKVE075F2BD	2.041,47
90	VKVE090E2D	1.439,90	VKVE090F2D	1.539,91	VKVE090E2BD	2.073,47	VKVE090F2BD	2.173,45
110	VKVE110E2D	1.937,29	VKVE110F2D	2.075,30	VKVE110E2BD	2.570,86	VKVE110F2BD	2.708,84
3/8"	VKVE038E2D	718,35	VKVE038F2D	729,08	VKVE038E2BD	1.351,91	VKVE038F2BD	1.362,63
1/2"	VKVE012E2D	720,83	VKVE012F2D	731,40	VKVE012E2BD	1.354,38	VKVE012F2BD	1.364,94
3/4"	VKVE034E2D	734,65	VKVE034F2D	744,86	VKVE034E2BD	1.368,20	VKVE034F2BD	1.378,40
1"	VKVE100E2D	749,24	VKVE100F2D	769,64	VKVE100E2BD	1.382,80	VKVE100F2BD	1.403,22
1 1/4"	VKVE114E2D	778,75	VKVE114F2D	795,66	VKVE114E2BD	1.412,31	VKVE114F2BD	1.429,18
1 1/2"	VKVE112E2D	809,84	VKVE112F2D	831,16	VKVE112E2BD	1.443,38	VKVE112F2BD	1.464,72
2"	VKVE200E2D	847,92	VKVE200F2D	890,26	VKVE200E2BD	1.481,45	VKVE200F2BD	1.523,81
2 1/2"	VKVE212E2D	1.359,24	VKVE212F2D	1.441,24	VKVE212E2BD	1.992,78	VKVE212F2BD	2.074,76
3"	VKVE300E2D	1.482,32	VKVE300F2D	1.582,37	VKVE300E2BD	2.115,88	VKVE300F2BD	2.215,91
4"	VKVE400E2D	1.984,98	VKVE400F2D	2.123,01	VKVE400E2BD	2.618,54	VKVE400F2BD	2.756,54

Válvula de bola motorizada en PVC-U 2 vías DUAL BLOCK®. Actuación eléctrica.

Disponemos de otras conexiones bajo pedido: bridas, encolar (BS, ASTM, JIS) y roscar (NPT, JIS). Bajo pedido podemos suministrar otros actuadores: VALPES, BELIMO...
Bajo pedido también disponibles en 12V AC/DC

VKRIV/CE

encolar.

VKRFV/CE

roscar.

ACTUACIÓN ELÉCTRICA 24-240 V AC/DC CON POSICIONADOR 4-20 mA

d	Ref.	€		Ref.	€		Ref.	€		Rh	
		EPDM	FKM		EPDM	FKM		EPDM	FKM		
16	VRVE016E2PD	1.390,65	1.400,72	VRVE016F2PD	1.400,72	1.400,72	VRVE038E2PD	1.394,38	VRVE038F2PD	1.394,38	3/8"
20	VRVE020E2PD	1.392,61	1.402,22	VRVE020F2PD	1.402,22	1.402,22	VRVE012E2PD	1.396,80	VRVE012F2PD	1.396,80	1/2"
25	VRVE025E2PD	1.419,97	1.432,34	VRVE025F2PD	1.432,34	1.432,34	VRVE034E2PD	1.425,66	VRVE034F2PD	1.425,66	3/4"
32	VRVE032E2PD	1.463,91	1.479,10	VRVE032F2PD	1.479,10	1.479,10	VRVE100E2PD	1.469,91	VRVE100F2PD	1.469,91	1"
40	VRVE040E2PD	1.487,03	1.503,61	VRVE040F2PD	1.503,61	1.503,61	VRVE114E2PD	1.496,44	VRVE114F2PD	1.496,44	1 1/4"
50	VRVE050E2PD	1.572,88	1.593,57	VRVE050F2PD	1.593,57	1.593,57	VRVE112E2PD	1.587,28	VRVE112F2PD	1.587,28	1 1/2"
63	VRVE063E2PD	1.592,06	1.632,95	VRVE063F2PD	1.632,95	1.632,95	VRVE200E2PD	1.611,87	VRVE200F2PD	1.611,87	2"

Válvula de bola REGULACIÓN motorizada en PVC-U 2 vías DUAL BLOCK®. Actuación eléctrica con posicionador 4-20 mA

Disponemos de otras conexiones bajo pedido: bridas, encolar (BS, ASTM, JIS) y roscar (NPT, JIS). Bajo pedido también disponibles en 12V AC/DC



K



K

VKDIV/CP
 encolar.

VKDFV/CP
 roscar.

ACTUACIÓN NEUMÁTICA ALUMINIO

ACTUACIÓN NEUMÁTICA ALUMINIO CON ELECTROVÁLVULA, FINALES DE CARRERA (ELECTROMECAÑICOS) Y REGULADORES DE ESCAPE

d-Rh	DOBLE EFECTO		SIMPLE EFECTO		DOBLE EFECTO		SIMPLE EFECTO	
	Ref.	€	Ref.	€	Ref.	€	Ref.	€
16	VKVP016EDED	329,34	VKVP016ESED	364,41	VKVP016EDEFD	558,49	VKVP016ESEFD	605,65
20	VKVP020EDED	331,22	VKVP020ESED	366,29	VKVP020EDEFD	560,39	VKVP020ESEFD	607,56
25	VKVP025EDED	343,54	VKVP025ESED	378,62	VKVP025EDEFD	572,70	VKVP025ESEFD	619,89
32	VKVP032EDED	357,95	VKVP032ESED	392,99	VKVP032EDEFD	587,10	VKVP032ESEFD	634,28
40	VKVP040EDED	383,98	VKVP040ESED	419,06	VKVP040EDEFD	613,14	VKVP040ESEFD	660,32
50	VKVP050EDED	410,17	VKVP050ESED	513,34	VKVP050EDEFD	639,31	VKVP050ESEFD	754,59
63	VKVP063EDED	442,79	VKVP063ESED	636,12	VKVP063EDEFD	671,94	VKVP063ESEFD	877,37
75	VKVP075EDED	756,32	VKVP075ESED	893,06	VKVP075EDEFD	985,45	VKVP075ESEFD	1.134,33
90	VKVP090EDED	870,31	VKVP090ESED	1.007,04	VKVP090EDEFD	1.099,45	VKVP090ESEFD	1.248,33
110	VKVP110EDED	967,16	VKVP110ESED	1.451,16	VKVP110EDEFD	1.196,31	VKVP110ESEFD	1.692,42

3/8"	VKVP038EDED	333,00	VKVP038ESED	368,09	VKVP038EDEFD	562,18	VKVP038ESEFD	609,34
1/2"	VKVP012EDED	335,50	VKVP012ESED	370,55	VKVP012EDEFD	564,65	VKVP012ESEFD	611,83
3/4"	VKVP034EDED	349,29	VKVP034ESED	384,38	VKVP034EDEFD	578,45	VKVP034ESEFD	625,63
1"	VKVP100EDED	363,88	VKVP100ESED	398,97	VKVP100EDEFD	593,06	VKVP100ESEFD	640,22
1 1/4"	VKVP114EDED	393,39	VKVP114ESED	428,49	VKVP114EDEFD	622,57	VKVP114ESEFD	669,76
1 1/2"	VKVP112EDED	424,49	VKVP112ESED	527,67	VKVP112EDEFD	653,65	VKVP112ESEFD	768,95
2"	VKVP200EDED	462,58	VKVP200ESED	655,86	VKVP200EDEFD	691,70	VKVP200ESEFD	897,12
2 1/2"	VKVP212EDED	789,64	VKVP212ESED	926,38	VKVP212EDEFD	1.018,78	VKVP212ESEFD	1.167,66
3"	VKVP300EDED	912,71	VKVP300ESED	1.049,47	VKVP300EDEFD	1.141,86	VKVP300ESEFD	1.290,70
4"	VKVP400EDED	1.014,85	VKVP400ESED	1.498,89	VKVP400EDEFD	1.244,02	VKVP400ESEFD	1.740,13

16	VKVP016FDED	339,41	VKVP016FSED	374,49	VKVP016FDEFD	568,57	VKVP016FSEFD	615,75
20	VKVP020FDED	340,92	VKVP020FSED	376,00	VKVP020FDEFD	570,07	VKVP020FSEFD	617,25
25	VKVP025FDED	355,98	VKVP025FSED	391,06	VKVP025FDEFD	585,15	VKVP025FSEFD	632,31
32	VKVP032FDED	373,11	VKVP032FSED	408,19	VKVP032FDEFD	602,29	VKVP032FSEFD	649,45
40	VKVP040FDED	400,54	VKVP040FSED	435,61	VKVP040FDEFD	629,70	VKVP040FSEFD	676,87
50	VKVP050FDED	430,82	VKVP050FSED	534,01	VKVP050FDEFD	660,00	VKVP050FSEFD	775,28
63	VKVP063FDED	483,62	VKVP063FSED	676,93	VKVP063FDEFD	712,79	VKVP063FSEFD	918,21
75	VKVP075FDED	838,29	VKVP075FSED	975,06	VKVP075FDEFD	1.067,46	VKVP075FSEFD	1.216,32
90	VKVP090FDED	970,27	VKVP090FSED	1.107,05	VKVP090FDEFD	1.199,43	VKVP090FSEFD	1.348,31
110	VKVP110FDED	1.105,14	VKVP110FSED	1.589,19	VKVP110FDEFD	1.334,31	VKVP110FSEFD	1.830,45

3/8"	VKVP038FDED	343,74	VKVP038FSED	378,82	VKVP038FDEFD	572,88	VKVP038FSEFD	620,08
1/2"	VKVP012FDED	346,05	VKVP012FSED	381,10	VKVP012FDEFD	575,20	VKVP012FSEFD	622,39
3/4"	VKVP034FDED	359,50	VKVP034FSED	394,58	VKVP034FDEFD	588,69	VKVP034FSEFD	635,84
1"	VKVP100FDED	384,32	VKVP100FSED	419,39	VKVP100FDEFD	613,43	VKVP100FSEFD	660,64
1 1/4"	VKVP114FDED	410,30	VKVP114FSED	445,36	VKVP114FDEFD	639,45	VKVP114FSEFD	686,63
1 1/2"	VKVP112FDED	445,80	VKVP112FSED	549,01	VKVP112FDEFD	674,97	VKVP112FSEFD	790,29
2"	VKVP200FDED	504,90	VKVP200FSED	698,21	VKVP200FDEFD	734,07	VKVP200FSEFD	939,47
2 1/2"	VKVP212FDED	871,59	VKVP212FSED	1.008,37	VKVP212FDEFD	1.100,77	VKVP212FSEFD	1.249,64
3"	VKVP300FDED	1.012,75	VKVP300FSED	1.149,52	VKVP300FDEFD	1.241,90	VKVP300FSEFD	1.390,79
4"	VKVP400FDED	1.152,85	VKVP400FSED	1.636,87	VKVP400FDEFD	1.382,01	VKVP400FSEFD	1.878,15

Válvula de bola motorizada en PVC-U 2 vías DUAL BLOCK®. Actuación eléctrica.

Disponemos de otras conexiones bajo pedido: bridas, encolar (BS, ASTM, JIS) y roscar (NPT, JIS). Las válvulas neumáticas se configuran NC (normalmente cerrada) de serie. La configuración NA (normalmente abierta) se debe especificar en el pedido.

VKRIV/CP

encolar.

VKRFV/CP

roscar.

ACTUACIÓN NEUMÁTICA ALUMINIO DOBLE EFECTO
CON POSICIONADOR 4-20 mAACTUACIÓN NEUMÁTICA ALUMINIO SIMPLE EFECTO
CON POSICIONADOR 4-20 mA

K

d-Rh	Ref.	€ EPDM	Ref.	€ FKM	Ref.	€ EPDM	Ref.	€ FKM
16	VRVP016EDEPD	2.516,88	VRVP016FDEPD	2.526,95	VRVP016ESEPD	2.551,92	VRVP016FSEPD	2.562,00
20	VRVP020EDEPD	2.518,81	VRVP020FDEPD	2.528,44	VRVP020ESEPD	2.553,89	VRVP020FSEPD	2.563,50
25	VRVP025EDEPD	2.546,17	VRVP025FDEPD	2.558,54	VRVP025ESEPD	2.581,23	VRVP025FSEPD	2.593,62
32	VRVP032EDEPD	2.590,15	VRVP032FDEPD	2.605,32	VRVP032ESEPD	2.625,24	VRVP032FSEPD	2.640,40
40	VRVP040EDEPD	2.613,25	VRVP040FDEPD	2.629,81	VRVP040ESEPD	2.648,32	VRVP040FSEPD	2.664,87
50	VRVP050EDEPD	2.699,09	VRVP050FDEPD	2.719,77	VRVP050ESEPD	2.802,29	VRVP050FSEPD	2.822,98
63	VRVP063EDEPD	2.718,27	VRVP063FDEPD	2.759,17	VRVP063ESEPD	2.911,57	VRVP063FSEPD	2.952,47
3/8"	VRVP038EDEPD	2.520,58	VRVP038FDEPD	2.520,58	VRVP038ESEPD	2.555,66	VRVP038FSEPD	2.555,66
1/2"	VRVP012EDEPD	2.523,02	VRVP012FDEPD	2.523,02	VRVP012ESEPD	2.558,09	VRVP012FSEPD	2.558,09
3/4"	VRVP034EDEPD	2.551,87	VRVP034FDEPD	2.551,87	VRVP034ESEPD	2.586,93	VRVP034FSEPD	2.586,93
1"	VRVP100EDEPD	2.596,11	VRVP100FDEPD	2.596,11	VRVP100ESEPD	2.631,17	VRVP100FSEPD	2.631,17
1 1/4"	VRVP114EDEPD	2.622,69	VRVP114FDEPD	2.622,69	VRVP114ESEPD	2.657,76	VRVP114FSEPD	2.657,76
1 1/2"	VRVP112EDEPD	2.713,50	VRVP112FDEPD	2.713,50	VRVP112ESEPD	2.816,70	VRVP112FSEPD	2.816,70
2"	VRVP200EDEPD	2.738,12	VRVP200FDEPD	2.738,12	VRVP200ESEPD	2.931,39	VRVP200FSEPD	2.931,39

Válvula de bola **REGULACIÓN** motorizada en PVC-U 2 vías DUAL BLOCK®.

Actuación neumática con posicionador 4-20 mA.

Disponemos de otras conexiones bajo pedido: bridas, encolar (BS, ASTM, JIS) y roscar (NPT, JIS)

Las válvulas neumáticas se configuran NC (normalmente cerrada) de serie.

La configuración NA (normalmente abierta) se debe especificar en el pedido.

VKRIV/CP

encolar.

VKRFV/CP

roscar.

ACTUACIÓN NEUMÁTICA POLIAMIDA DOBLE EFECTO
CON POSICIONADOR 4-20 mAACTUACIÓN NEUMÁTICA POLIAMIDA SIMPLE EFECTO
CON POSICIONADOR 4-20 mA

K

d-Rh	Ref.	€ EPDM	Ref.	€ FKM	Ref.	€ EPDM	Ref.	€ FKM
16	VRVP016EDEPP	2.014,66	VRVP016FDEPP	2.024,72	VRVP016ESEPP	2.041,09	VRVP016FSEPP	2.051,14
20	VRVP020EDEPP	2.016,62	VRVP020FDEPP	2.026,23	VRVP020ESEPP	2.043,05	VRVP020FSEPP	2.052,66
25	VRVP025EDEPP	2.043,98	VRVP025FDEPP	2.056,32	VRVP025ESEPP	2.070,40	VRVP025FSEPP	2.082,74
32	VRVP032EDEPP	2.087,93	VRVP032FDEPP	2.103,12	VRVP032ESEPP	2.233,27	VRVP032FSEPP	2.248,46
40	VRVP040EDEPP	2.111,03	VRVP040FDEPP	2.127,58	VRVP040ESEPP	2.256,35	VRVP040FSEPP	2.272,92
50	VRVP050EDEPP	2.196,88	VRVP050FDEPP	2.217,55	VRVP050ESEPP	2.480,95	VRVP050FSEPP	2.501,61
63	VRVP063EDEPP	2.449,14	VRVP063FDEPP	2.490,02	VRVP063ESEPP	2.525,09	VRVP063FSEPP	2.566,00
3/8"	VRVP038EDEPP	2.018,36	VRVP038FDEPP	2.018,36	VRVP038ESEPP	2.044,78	VRVP038FSEPP	2.044,78
1/2"	VRVP012EDEPP	2.020,78	VRVP012FDEPP	2.020,78	VRVP012ESEPP	2.047,23	VRVP012FSEPP	2.047,23
3/4"	VRVP034EDEPP	2.049,64	VRVP034FDEPP	2.049,64	VRVP034ESEPP	2.076,08	VRVP034FSEPP	2.076,08
1"	VRVP100EDEPP	2.093,88	VRVP100FDEPP	2.093,88	VRVP100ESEPP	2.239,20	VRVP100FSEPP	2.239,20
1 1/4"	VRVP114EDEPP	2.120,44	VRVP114FDEPP	2.120,44	VRVP114ESEPP	2.265,79	VRVP114FSEPP	2.265,79
1 1/2"	VRVP112EDEPP	2.211,28	VRVP112FDEPP	2.211,28	VRVP112ESEPP	2.495,34	VRVP112FSEPP	2.495,34
2"	VRVP200EDEPP	2.468,96	VRVP200FDEPP	2.468,96	VRVP200ESEPP	2.544,91	VRVP200FSEPP	2.544,91

Válvula de bola **REGULACIÓN** motorizada en PVC-U 2 vías DUAL BLOCK®.

Actuación neumática con posicionador 4-20 mA.

Disponemos de otras conexiones bajo pedido: bridas, encolar (BS, ASTM, JIS) y roscar (NPT, JIS)

Las válvulas neumáticas se configuran NC (normalmente cerrada) de serie.

La configuración NA (normalmente abierta) se debe especificar en el pedido.



K

VKDIV/CP

encolar.

VKDFV/CP

roscar.

ACTUACIÓN NEUMÁTICA POLIAMIDA

ACTUACIÓN NEUMÁTICA POLIAMIDA CON ELECTROVÁLVULA, FINALES DE CARRERA (ELECTROMECAÑICOS) Y REGULADORES DE ESCAPE

d-Rh	DOBLE EFECTO		SIMPLE EFECTO		DOBLE EFECTO		SIMPLE EFECTO	
	Ref.	€	Ref.	€	Ref.	€	Ref.	€
16	VKVP016EDEP	350,72	VKVP016ESEP	377,18	VKVP016EDEFP	650,50	VKVP016ESEFP	676,93
20	VKVP020EDEP	352,64	VKVP020ESEP	379,06	VKVP020EDEFP	652,39	VKVP020ESEFP	678,83
25	VKVP025EDEP	364,90	VKVP025ESEP	391,35	VKVP025EDEFP	664,69	VKVP025ESEFP	691,12
32	VKVP032EDEP	379,35	VKVP032ESEP	524,69	VKVP032EDEFP	679,09	VKVP032ESEFP	824,43
40	VKVP040EDEP	405,38	VKVP040ESEP	550,69	VKVP040EDEFP	705,15	VKVP040ESEFP	850,46
50	VKVP050EDEP	431,55	VKVP050ESEP	715,60	VKVP050EDEFP	731,30	VKVP050ESEFP	1.015,37
63	VKVP063EDEP	697,28	VKVP063ESEP	773,26	VKVP063EDEFP	997,06	VKVP063ESEFP	1.073,01
75	VKVP075EDEP	903,67	VKVP075ESEP	1.188,25	VKVP075EDEFP	1.203,44	VKVP075ESEFP	1.488,01
90	VKVP090EDEP	1.017,65	VKVP090ESEP	1.302,25	VKVP090EDEFP	1.317,42	VKVP090ESEFP	1.602,01
110	VKVP110EDEP	1.076,36	VKVP110ESEP	1.385,20	VKVP110EDEFP	1.376,11	VKVP110ESEFP	1.684,97

3/8"	VKVP038EDEP	354,42	VKVP038ESEP	380,86	VKVP038EDEFP	654,17	VKVP038ESEFP	680,61
1/2"	VKVP012EDEP	356,91	VKVP012ESEP	383,31	VKVP012EDEFP	656,65	VKVP012ESEFP	683,08
3/4"	VKVP034EDEP	370,67	VKVP034ESEP	397,11	VKVP034EDEFP	670,44	VKVP034ESEFP	696,87
1"	VKVP100EDEP	385,30	VKVP100ESEP	530,61	VKVP100EDEFP	685,06	VKVP100ESEFP	830,41
1 1/4"	VKVP114EDEP	414,77	VKVP114ESEP	560,13	VKVP114EDEFP	714,55	VKVP114ESEFP	859,88
1 1/2"	VKVP112EDEP	445,86	VKVP112ESEP	729,97	VKVP112EDEFP	745,63	VKVP112ESEFP	1.029,71
2"	VKVP200EDEP	717,05	VKVP200ESEP	793,00	VKVP200EDEFP	1.016,81	VKVP200ESEFP	1.092,77
2 1/2"	VKVP212EDEP	936,98	VKVP212ESEP	1.221,55	VKVP212EDEFP	1.236,76	VKVP212ESEFP	1.521,31
3"	VKVP300EDEP	1.060,04	VKVP300ESEP	1.344,64	VKVP300EDEFP	1.359,83	VKVP300ESEFP	1.644,39
4"	VKVP400EDEP	1.124,05	VKVP400ESEP	1.432,92	VKVP400EDEFP	1.423,81	VKVP400ESEFP	1.732,69

16	VKVP016FDEP	360,81	VKVP016FSEP	387,26	VKVP016FDEFP	660,58	VKVP016FSEFP	687,03
20	VKVP020FDEP	362,31	VKVP020FSEP	388,75	VKVP020FDEFP	662,09	VKVP020FSEFP	688,52
25	VKVP025FDEP	377,36	VKVP025FSEP	403,81	VKVP025FDEFP	677,14	VKVP025FSEFP	703,59
32	VKVP032FDEP	394,52	VKVP032FSEP	539,84	VKVP032FDEFP	694,26	VKVP032FSEFP	839,60
40	VKVP040FDEP	421,93	VKVP040FSEP	567,27	VKVP040FDEFP	721,69	VKVP040FSEFP	867,02
50	VKVP050FDEP	452,24	VKVP050FSEP	736,30	VKVP050FDEFP	751,98	VKVP050FSEFP	1.036,06
63	VKVP063FDEP	738,12	VKVP063FSEP	814,08	VKVP063FDEFP	1.037,86	VKVP063FSEFP	1.113,87
75	VKVP075FDEP	985,67	VKVP075FSEP	1.270,25	VKVP075FDEFP	1.285,41	VKVP075FSEFP	1.570,00
90	VKVP090FDEP	1.117,62	VKVP090FSEP	1.402,22	VKVP090FDEFP	1.417,39	VKVP090FSEFP	1.701,99
110	VKVP110FDEP	1.214,36	VKVP110FSEP	1.523,22	VKVP110FDEFP	1.514,11	VKVP110FSEFP	1.822,99

3/8"	VKVP038FDEP	365,15	VKVP038FSEP	391,57	VKVP038FDEFP	664,90	VKVP038FSEFP	691,32
1/2"	VKVP012FDEP	367,41	VKVP012FSEP	393,85	VKVP012FDEFP	667,18	VKVP012FSEFP	693,62
3/4"	VKVP034FDEP	380,91	VKVP034FSEP	407,35	VKVP034FDEFP	680,66	VKVP034FSEFP	707,09
1"	VKVP100FDEP	405,70	VKVP100FSEP	551,04	VKVP100FDEFP	705,48	VKVP100FSEFP	850,80
1 1/4"	VKVP114FDEP	431,70	VKVP114FSEP	577,02	VKVP114FDEFP	731,44	VKVP114FSEFP	876,79
1 1/2"	VKVP112FDEP	467,22	VKVP112FSEP	751,27	VKVP112FDEFP	766,97	VKVP112FSEFP	1.051,04
2"	VKVP200FDEP	759,39	VKVP200FSEP	835,34	VKVP200FDEFP	1.059,14	VKVP200FSEFP	1.135,12
2 1/2"	VKVP212FDEP	1.018,98	VKVP212FSEP	1.303,52	VKVP212FDEFP	1.318,74	VKVP212FSEFP	1.603,29
3"	VKVP300FDEP	1.160,11	VKVP300FSEP	1.444,69	VKVP300FDEFP	1.459,87	VKVP300FSEFP	1.744,43
4"	VKVP400FDEP	1.262,08	VKVP400FSEP	1.570,93	VKVP400FDEFP	1.561,83	VKVP400FSEFP	1.870,72

Válvula de bola motorizada en PVC-U 2 vías DUAL BLOCK®. Actuación neumática.

Disponemos de otras conexiones bajo pedido: bridas, encolar (BS, ASTM, JIS) y roscar (NPT, JIS). Las válvulas neumáticas se configuran NC (normalmente cerrada) de serie. La configuración NA (normalmente abierta) se debe especificar en el pedido.



INDUSTRIA

Válvulas motorizadas de PVC-U presión

Válvulas de 3 vías actuadas



K

LKDIV/CE
encolar.

LKDFV/CE
roscar.

ACTUACIÓN ELÉCTRICA

ACTUACIÓN ELÉCTRICA CON BLOQUE DE SEGURIDAD

d-Rh	24-240 V AC/DC		24-240 V AC/DC		24-240 V AC/DC		24-240 V AC/DC	
	Ref.	€	Ref.	€	Ref.	€	Ref.	€
16	LKVE016E2D	799,42	LKVE016F2D	816,64	LKVE016E2BD	1.432,99	LKVE016F2BD	1.450,18
20	LKVE020E2D	802,17	LKVE020F2D	819,71	LKVE020E2BD	1.435,73	LKVE020F2BD	1.453,28
25	LKVE025E2D	826,70	LKVE025F2D	850,16	LKVE025E2BD	1.460,28	LKVE025F2BD	1.483,69
32	LKVE032E2D	864,15	LKVE032F2D	893,19	LKVE032E2BD	1.497,69	LKVE032F2BD	1.526,76
40	LKVE040E2D	912,36	LKVE040F2D	954,45	LKVE040E2BD	1.545,94	LKVE040F2BD	1.588,01
50	LKVE050E2D	960,98	LKVE050F2D	1.031,52	LKVE050E2BD	1.594,55	LKVE050F2BD	1.665,07
63	LKVE063E2D	1.038,92	LKVE063F2D	1.127,97	LKVE063E2BD	1.672,48	LKVE063F2BD	1.761,52
3/8"	LKVE038E2D	811,45	LKVE038F2D	828,68	LKVE038E2BD	1.445,03	LKVE038F2BD	1.462,22
1/2"	LKVE012E2D	814,42	LKVE012F2D	832,03	LKVE012E2BD	1.447,98	LKVE012F2BD	1.465,55
3/4"	LKVE034E2D	840,85	LKVE034F2D	864,29	LKVE034E2BD	1.474,40	LKVE034F2BD	1.497,86
1"	LKVE100E2D	881,66	LKVE100F2D	910,72	LKVE100E2BD	1.515,21	LKVE100F2BD	1.544,30
1 1/4"	LKVE114E2D	933,65	LKVE114F2D	975,65	LKVE114E2BD	1.567,20	LKVE114F2BD	1.609,22
1 1/2"	LKVE112E2D	986,66	LKVE112F2D	1.057,24	LKVE112E2BD	1.620,18	LKVE112F2BD	1.690,80
2"	LKVE200E2D	1.071,32	LKVE200F2D	1.160,31	LKVE200E2BD	1.704,87	LKVE200F2BD	1.793,87

Válvula de bola motorizada en PVC-U 3 vías DUAL BLOCK®. Actuación eléctrica.

Estándar paso en L, paso en T opcional, al mismo precio. Bajo pedido podemos suministrar otros actuadores: VALPES, BELIMO... Disponemos de otras conexiones bajo pedido: bridas, encolar (BS, ASTM, JIS) y roscar (NPT, JIS). Bajo pedido también disponibles en 12V AC/DC



M1



M1

Medida	Ref. EPDM	DN	PN	€
140	63072	125	10	1.750,87

Válvula Ø 140 con actuador neumático. Brida.

Medida	Ref. EPDM	DN	PN	€
140	63073	125	10	2.739,45

Válvula Ø 140 con actuador eléctrico. Brida.

LKDIV/CP

encolar.

LKDFV/CP

roscar.

ACTUACIÓN NEUMÁTICA ALUMINIO

ACTUACIÓN NEUMÁTICA ALUMINIO CON ELECTROVÁLVULA, FINALES DE CARRERA (ELECTROMECAÑICOS) Y REGULADORES DE ESCAPE



K

	d-Rh	DOBLE EFECTO		SIMPLE EFECTO		DOBLE EFECTO		SIMPLE EFECTO	
		Ref.	€	Ref.	€	Ref.	€	Ref.	€
ENCOLAR	16	LKVP016EDED	449,23	LKVP016ESED	449,16	LKVP016EDEFD	643,23	LKVP016ESEFD	690,41
	20	LKVP020EDED	416,81	LKVP020ESED	451,92	LKVP020EDEFD	645,99	LKVP020ESEFD	693,16
	25	LKVP025EDED	441,38	LKVP025ESED	476,44	LKVP025EDEFD	670,51	LKVP025ESEFD	717,71
	32	LKVP032EDED	478,79	LKVP032ESED	513,87	LKVP032EDEFD	707,96	LKVP032ESEFD	755,12
	40	LKVP040EDED	527,00	LKVP040ESED	630,20	LKVP040EDEFD	756,15	LKVP040ESEFD	871,48
ROSCAR	50	LKVP050EDED	616,48	LKVP050ESED	768,95	LKVP050EDEFD	845,64	LKVP050ESEFD	1.010,17
	63	LKVP063EDED	694,40	LKVP063ESED	846,86	LKVP063EDEFD	923,55	LKVP063ESEFD	1.088,12
ROSCAR	3/8"	LKVP038EDED	426,10	LKVP038ESED	461,19	LKVP038EDEFD	655,26	LKVP038ESEFD	702,44
	1/2"	LKVP012EDED	429,05	LKVP012ESED	464,15	LKVP012EDEFD	658,21	LKVP012ESEFD	705,38
	3/4"	LKVP034EDED	455,48	LKVP034ESED	490,58	LKVP034EDEFD	684,64	LKVP034ESEFD	731,83
	1"	LKVP100EDED	496,34	LKVP100ESED	531,41	LKVP100EDEFD	725,49	LKVP100ESEFD	772,67
ROSCAR	1 1/4"	LKVE114EDED	548,28	LKVP114ESED	651,49	LKVP114EDEFD	777,44	LKVP114ESEFD	892,77
	1 1/2"	LKVP112EDED	642,14	LKVP112ESED	794,60	LKVP112EDEFD	871,27	LKVP112ESEFD	1.035,83
ROSCAR	2"	LKVP200EDED	726,80	LKVP200ESED	879,29	LKVP200EDEFD	955,98	LKVP200ESEFD	1.120,53
ENCOLAR	16	LKVP016FDED	431,28	LKVP016FSED	466,37	LKVP016FDEFD	660,43	LKVP016FSEFD	707,63
	20	LKVP020FDED	434,35	LKVP020FSED	469,43	LKVP020FDEFD	663,53	LKVP020FSEFD	710,71
	25	LKVP025FDED	464,80	LKVP025FSED	499,85	LKVP025FDEFD	693,96	LKVP025FSEFD	741,13
	32	LKVP032FDED	507,85	LKVP032FSED	542,90	LKVP032FDEFD	737,00	LKVP032FSEFD	784,17
	40	LKVP040FDED	569,11	LKVP040FSED	672,30	LKVP040FDEFD	798,28	LKVP040FSEFD	913,58
ROSCAR	50	LKVP050FDED	687,03	LKVP050FSED	839,48	LKVP050FDEFD	916,16	LKVP050FSEFD	1.080,73
	63	LKVP063FDED	783,45	LKVP063FSED	935,92	LKVP063FDEFD	1.012,62	LKVP063FSEFD	1.177,20
ROSCAR	3/8"	LKVP038FDED	443,32	LKVP038FSED	478,41	LKVP038FDEFD	672,48	LKVP038FSEFD	719,68
	1/2"	LKVP012FDED	446,66	LKVP012FSED	481,72	LKVP012FDEFD	675,83	LKVP012FSEFD	723,00
	3/4"	LKVP034FDED	478,91	LKVP034FSED	514,00	LKVP034FDEFD	708,08	LKVP034FSEFD	755,24
	1"	LKVP100FDED	525,38	LKVP100FSED	560,46	LKVP100FDEFD	754,53	LKVP100FSEFD	801,72
ROSCAR	1 1/4"	LKVE114FDED	590,31	LKVP114FSED	693,51	LKVP114FDEFD	819,45	LKVP114FSEFD	934,73
	1 1/2"	LKVP112FDED	712,73	LKVP112FSED	865,21	LKVP112FDEFD	941,89	LKVP112FSEFD	1.106,45
ROSCAR	2"	LKVP200FDED	815,79	LKVP200FSED	968,25	LKVP200FDEFD	1.044,94	LKVP200FSEFD	1.209,49

Válvula de bola motorizada en PVC-U 3 vías DUAL BLOCK®.

Actuación neumática.

Estándar paso en L, paso en T opcional, al mismo precio. Disponemos de otras conexiones bajo pedido: bridas, encolar (BS, ASTM, JIS) y roscar (NPT, JIS).

Las válvulas neumáticas se configuran NC (normalmente cerrada) de serie. La configuración NA (normalmente abierta) se debe especificar en el pedido.

LKDIV/CP

encolar.

LKDFV/CP

roscar.

ACTUACIÓN NEUMÁTICA POLIAMIDA

ACTUACIÓN NEUMÁTICA POLIAMIDA CON ELECTROVÁLVULA, FINALES DE CARRERA (ELECTROMECÁNICOS) Y REGULADORES DE ESCAPE



K

	d-Rh	DOBLE EFECTO		SIMPLE EFECTO		DOBLE EFECTO		SIMPLE EFECTO	
		Ref.	€	Ref.	€	Ref.	€	Ref.	€
ENCOLAR	16	LKVP016EDEP	480,50	LKVP016ESEP	506,93	LKVP016EDEFP	780,26	LKVP016ESEFP	806,72
	20	LKVP020EDEP	483,23	LKVP020ESEP	509,68	LKVP020EDEFP	782,99	LKVP020ESEFP	809,46
	25	LKVP025EDEP	559,42	LKVP025ESEP	585,86	LKVP025EDEFP	859,17	LKVP025ESEFP	885,60
	32	LKVP032EDEP	596,83	LKVP032ESEP	742,16	LKVP032EDEFP	896,61	LKVP032ESEFP	1.041,95
	40	LKVP040EDEP	662,09	LKVP040ESEP	946,12	LKVP040EDEFP	961,86	LKVP040ESEFP	1.245,88
	ROSCAR	50	LKVP050EDEP	816,92	LKVP050ESEP	991,92	LKVP050EDEFP	1.116,66	LKVP050ESEFP
63		LKVP063EDEP	981,80	LKVP063ESEP	1.057,76	LKVP063EDEFP	1.281,56	LKVP063ESEFP	1.357,54
3/8"		LKVP038EDEP	492,55	LKVP038ESEP	518,97	LKVP038EDEFP	792,28	LKVP038ESEFP	818,72
ROSCAR	1/2"	LKVP012EDEP	495,49	LKVP012ESEP	521,92	LKVP012EDEFP	795,24	LKVP012ESEFP	821,68
	3/4"	LKVP034EDEP	573,55	LKVP034ESEP	599,97	LKVP034EDEFP	873,30	LKVP034ESEFP	899,74
	1"	LKVP100EDEP	614,38	LKVP100ESEP	759,72	LKVP100EDEFP	914,15	LKVP100ESEFP	1.059,48
ROSCAR	1 1/4"	LKVP114EDEP	683,33	LKVP114ESEP	967,40	LKVP114EDEFP	983,10	LKVP114ESEFP	1.267,16
	1 1/2"	LKVP112EDEP	842,55	LKVP112ESEP	1.017,59	LKVP112EDEFP	1.142,33	LKVP112ESEFP	1.317,35
	2"	LKVP200EDEP	1.014,18	LKVP200ESEP	1.090,16	LKVP200EDEFP	1.313,98	LKVP200ESEFP	1.389,92
ENCOLAR	16	LKVP016FDEP	497,71	LKVP016FSEP	524,16	LKVP016FDEFP	797,46	LKVP016FSEFP	823,91
	20	LKVP020FDEP	500,79	LKVP020FSEP	527,24	LKVP020FDEFP	800,54	LKVP020FSEFP	826,99
	25	LKVP025FDEP	582,82	LKVP025FSEP	609,26	LKVP025FDEFP	882,60	LKVP025FSEFP	909,04
	32	LKVP032FDEP	625,89	LKVP032FSEP	771,22	LKVP032FDEFP	925,67	LKVP032FSEFP	1.070,99
	40	LKVP040FDEP	704,15	LKVP040FSEP	988,24	LKVP040FDEFP	1.003,93	LKVP040FSEFP	1.287,97
	ROSCAR	50	LKVP050FDEP	887,44	LKVP050FSEP	1.062,49	LKVP050FDEFP	1.187,21	LKVP050FSEFP
63		LKVP063FDEP	1.070,88	LKVP063FSEP	1.146,83	LKVP063FDEFP	1.370,66	LKVP063FSEFP	1.446,59
3/8"		LKVP038FDEP	509,74	LKVP038FSEP	536,16	LKVP038FDEFP	809,51	LKVP038FSEFP	835,95
ROSCAR	1/2"	LKVP012FDEP	513,08	LKVP012FSEP	539,53	LKVP012FDEFP	812,85	LKVP012FSEFP	839,28
	3/4"	LKVP034FDEP	596,97	LKVP034FSEP	623,42	LKVP034FDEFP	896,73	LKVP034FSEFP	923,19
	1"	LKVP100FDEP	643,43	LKVP100FSEP	788,77	LKVP100FDEFP	943,18	LKVP100FSEFP	1.088,52
ROSCAR	1 1/4"	LKVP114FDEP	725,34	LKVP114FSEP	1.009,41	LKVP114FDEFP	1.025,10	LKVP114FSEFP	1.309,16
	1 1/2"	LKVP112FDEP	913,17	LKVP112FSEP	1.088,18	LKVP112FDEFP	1.212,92	LKVP112FSEFP	1.387,96
	2"	LKVP200FDEP	1.103,17	LKVP200FSEP	1.179,17	LKVP200FDEFP	1.402,94	LKVP200FSEFP	1.478,91

Válvula de bola motorizada en PVC-U 3 vías DUAL BLOCK®.

Actuación neumática.

Estándar paso en L, paso en T opcional, al mismo precio. Disponemos de otras conexiones bajo pedido: bridas, encolar (BS, ASTM, JIS) y roscar (NPT, JIS).

Las válvulas neumáticas se configuran NC (normalmente cerrada) de serie. La configuración NA (normalmente abierta) se debe especificar en el pedido.



INDUSTRIA

Válvulas motorizadas de PVC-U presión

Válvulas de mariposa actuadas



K

FEOV/CE

ACTUACIÓN ELÉCTRICA

ACTUACIÓN ELÉCTRICA CON BLOQUE DE SEGURIDAD

d	24-240 V AC/DC		24-240 V AC/DC		24-240 V AC/DC		24-240 V AC/DC	
	Ref.	€ EPDM	Ref.	€ FKM	Ref.	€ EPDM	Ref.	€ FKM
50	FEVE050E2D	760,91	FEVE050F2D	872,99	FEVE050E2BD	1.394,44	FEVE050F2BD	1.506,54
63	FEVE063E2D	767,44	FEVE063F2D	886,60	FEVE063E2BD	1.400,98	FEVE063F2BD	1.520,15
75	FEVE075E2D	1.069,17	FEVE075F2D	1.186,28	FEVE075E2BD	1.702,71	FEVE075F2BD	1.819,83
90	FEVE090E2D	1.087,30	FEVE090F2D	1.241,98	FEVE090E2BD	1.720,83	FEVE090F2BD	1.875,53
110	FEVE110E2D	1.111,95	FEVE110F2D	1.313,70	FEVE110E2BD	1.745,49	FEVE110F2BD	1.947,25
125 (A1)	FEVE140E2D	1.558,42	FEVE140F2D	1.851,12	FEVE140E2BD	2.191,99	FEVE140F2BD	2.484,68
140	FEVE140E2D	1.558,42	FEVE140F2D	1.851,12	FEVE140E2BD	2.191,99	FEVE140F2BD	2.484,68
160	FEVE160E2D	1.884,88	FEVE160F2D	2.350,43	FEVE160E2BD	2.626,27	FEVE160F2BD	3.091,84
200*(A2)	FEVE225E2D	2.211,91	FEVE225F2D	2.814,73	FEVE225E2BD	2.953,31	FEVE225F2BD	3.556,11
225*	FEVE225E2D	2.211,91	FEVE225F2D	2.814,73	FEVE225E2BD	2.953,31	FEVE225F2BD	3.556,11
250*(A3)	FEVE280E2D	3.142,00			FEVE280E2BD	3.883,37		
280	FEVE280E2D	3.142,00			FEVE280E2BD	3.883,37		
315	FEVE315E2D	3.451,76			FEVE315E2BD	4.193,15		

Válvula de mariposa motorizada en PVC-U.

Actuación eléctrica.

(A1) = a utilizar con portabridas QPV especial no incluido (transforma la válvula de mariposa de 140 en 125)

(A2) = a utilizar con portabridas QPV especial no incluido (transforma la válvula de mariposa de 225 en 200)

(A3) = a utilizar con tubo de diámetro 250 SDR 26 (PN10).

Bajo pedido podemos suministrar otros actuadores: VALPES, BELIMO... [Bajo pedido también disponibles en 12V AC/DC](#)

FEOV/CP

K

ACTUACIÓN NEUMÁTICA ALUMINIO
ACTUACIÓN NEUMÁTICA ALUMINIO CON ELECTROVÁLVULA, FINALES DE CARRERA (ELECTROMECAÑICOS) Y REGULADORES DE ESCAPE

d	DOBLE EFECTO		SIMPLE EFECTO		DOBLE EFECTO		SIMPLE EFECTO	
	Ref.	€	Ref.	€	Ref.	€	Ref.	€
50	FEVP050EDED	375,16	FEVP050ESED	478,36	FEVP050EDEFD	604,34	FEVP050ESEFD	719,60
63	FEVP063EDED	381,68	FEVP063ESED	484,90	FEVP063EDEFD	610,83	FEVP063ESEFD	726,17
75	FEVP075EDED	427,70	FEVP075ESED	580,17	FEVP075EDEFD	656,82	FEVP075ESEFD	821,42
90	FEVP090EDED	517,27	FEVP090ESED	654,02	FEVP090EDEFD	746,43	FEVP090ESEFD	895,29
110	FEVP110EDED	541,94	FEVP110ESED	1.056,80	FEVP110EDEFD	771,11	FEVP110ESEFD	1.298,06
125 (A1)	FEVP140EDED	607,90	FEVP140ESED	1.381,61	FEVP140EDEFD	837,04	FEVP140ESEFD	1.622,89
140	FEVP140EDED	607,90	FEVP140ESED	1.381,61	FEVP140EDEFD	837,04	FEVP140ESEFD	1.622,89
160	FEVP160EDED	658,01	FEVP160ESED	1.431,73	FEVP160EDEFD	887,17	FEVP160ESEFD	1.673,01
200 (A2)	FEVP225EDED	1.143,76	FEVP225ESED	2.205,65	FEVP225EDEFD	1.372,91	FEVP225ESEFD	2.446,91
225	FEVP225EDED	1.143,76	FEVP225ESED	2.205,65	FEVP225EDEFD	1.372,91	FEVP225ESEFD	2.446,91
250 (A3)	FEVP280EDED	2.280,44	FEVP280ESED	4.531,67	FEVP280EDEFD	2.509,61	FEVP280ESEFD	4.772,98
280	FEVP280EDED	2.280,44	FEVP280ESED	4.531,67	FEVP280EDEFD	2.509,61	FEVP280ESEFD	4.772,98
315	FEVP315EDED	2.896,41	FEVP315ESED	6.004,47	FEVP315EDEFD	3.125,54	FEVP315ESEFD	6.245,74
50	FEVP050FDED	487,23	FEVP050FSED	590,43	FEVP050FDEFD	716,41	FEVP050FSEFD	831,70
63	FEVP063FDED	500,84	FEVP063FSED	604,04	FEVP063FDEFD	730,02	FEVP063FSEFD	845,30
75	FEVP075FDED	544,82	FEVP075FSED	697,28	FEVP075FDEFD	773,99	FEVP075FSEFD	938,54
90	FEVP090FDED	671,94	FEVP090FSED	808,73	FEVP090FDEFD	901,12	FEVP090FSEFD	1.049,98
110	FEVP110FDED	743,69	FEVP110FSED	1.258,52	FEVP110FDEFD	972,84	FEVP110FSEFD	1.499,80
125 (A1)	FEVP140FDED	900,61	FEVP140FSED	1.674,33	FEVP140FDEFD	1.129,74	FEVP140FSEFD	1.915,60
140	FEVP140FDED	900,61	FEVP140FSED	1.674,33	FEVP140FDEFD	1.129,74	FEVP140FSEFD	1.915,60
160	FEVP160FDED	1.123,63	FEVP160FSED	1.897,32	FEVP160FDEFD	1.352,75	FEVP160FSEFD	2.138,59
200 (A2)	FEVP225FDED	1.746,53	FEVP225FSED	2.808,44	FEVP225FDEFD	1.975,70	FEVP225FSEFD	3.049,71
225	FEVP225FDE	1.746,53	FEVP225FSED	2.808,44	FEVP225FDEFD	1.975,70	FEVP225FSEFD	3.049,71

Válvula de mariposa motorizada en PVC-U.

Actuación neumática.

(A1) = a utilizar con portabridas QPV especial no incluido (transforma la válvula de mariposa de 140 en 125)

(A2) = a utilizar con portabridas QPV especial no incluido (transforma la válvula de mariposa de 225 en 200)

(A3) = a utilizar con tubo de diámetro 250 SDR 26 (PN10)

Las válvulas neumáticas se configuran NC (normalmente cerrada) de serie.

La configuración NA (normalmente abierta) se debe especificar en el pedido.



K

FEOV/CP

ACTUACIÓN NEUMÁTICA POLIAMIDA

ACTUACIÓN NEUMÁTICA POLIAMIDA CON ELECTROVÁLVULA, FINALES DE CARRERA (ELECTROMECAÑICOS) Y REGULADORES DE ESCAPE

d	DOBLE EFECTO		SIMPLE EFECTO		DOBLE EFECTO		SIMPLE EFECTO	
	Ref.	€	Ref.	€	Ref.	€	Ref.	€
50	FEVP050EDEP	497,31	FEVP050ESEP	683,68	FEVP050EDEFPP	797,07	FEVP050ESEFP	983,42
63	FEVP063EDEP	503,85	FEVP063ESEP	690,21	FEVP063EDEFPP	803,61	FEVP063ESEFP	989,98
75	FEVP075EDEP	509,05	FEVP075ESEP	695,39	FEVP075EDEFPP	808,79	FEVP075ESEFP	995,15
90	FEVP090EDEP	637,16	FEVP090ESEP	713,12	FEVP090EDEFPP	936,92	FEVP090ESEFP	1.012,86
110	FEVP110EDEP	661,81	FEVP110ESEP	960,80	FEVP110EDEFPP	961,58	FEVP110ESEFP	1.260,59
125 (A1)	FEVP140EDEP	680,61	FEVP140ESEP	1.322,40	FEVP140EDEFPP	980,37	FEVP140ESEFP	1.622,18
140	FEVP140EDEP	680,61	FEVP140ESEP	1.322,40	FEVP140EDEFPP	980,37	FEVP140ESEFP	1.622,18
160	FEVP160EDEP	940,43	FEVP160ESEP	1.372,51	FEVP160EDEFPP	1.240,19	FEVP160ESEFP	1.672,26
200 (A2)	FEVP225EDEP	1.122,47	FEVP225ESEP	2.014,18	FEVP225EDEFPP	1.422,22	FEVP225ESEFP	2.313,96
225	FEVP225EDEP	1.122,47	FEVP225ESEP	2.014,18	FEVP225EDEFPP	1.422,22	FEVP225ESEFP	2.313,96
250*(A3)	FEVP280EDEP	2.484,55	FEVP280ESEP	4.396,03	FEVP280EDEFPP	2.784,27	FEVP280ESEFP	4.695,81
280*	FEVP280EDEP	2.484,55	FEVP280ESEP	4.396,03	FEVP280EDEFPP	2.784,27	FEVP280ESEFP	4.695,81
315*	FEVP315EDEP	2.794,30	FEVP315ESEP	4.705,82	FEVP315EDEFPP	3.094,08	FEVP315ESEFP	5.005,57
50	FEVP050FDEP	609,40	FEVP050FSEP	795,77	FEVP050FDEFPP	909,16	FEVP050FSEFP	1.095,54
63	FEVP063FDEP	623,02	FEVP063FSEP	809,39	FEVP063FDEFPP	922,79	FEVP063FSEFP	1.109,15
75	FEVP075FDEP	626,14	FEVP075FSEP	812,51	FEVP075FDEFPP	925,91	FEVP075FSEFP	1.112,28
90	FEVP090FDEP	791,85	FEVP090FSEP	867,83	FEVP090FDEFPP	1.091,61	FEVP090FSEFP	1.167,57
110	FEVP110FDEP	863,54	FEVP110FSEP	1.162,52	FEVP110FDEFPP	1.163,31	FEVP110FSEFP	1.462,28
125 (A1)	FEVP140FDEP	973,28	FEVP140FSEP	1.615,10	FEVP140FDEFPP	1.273,05	FEVP140FSEFP	1.914,84
140	FEVP140FDEP	973,28	FEVP140FSEP	1.615,10	FEVP140FDEFPP	1.273,05	FEVP140FSEFP	1.914,84
160	FEVP160FDEP	1.406,01	FEVP160FSEP	1.838,11	FEVP160FDEFPP	1.705,78	FEVP160FSEFP	2.137,88
200 (A2)	FEVP225FDEP	1.725,25	FEVP225FSEP	2.616,97	FEVP225FDEFPP	2.025,03	FEVP225FSEFP	2.916,74
225	FEVP225FDEP	1.725,25	FEVP225FSEP	2.616,97	FEVP225FDEFPP	2.025,03	FEVP225FSEFP	2.916,74

Válvula de mariposa motorizada en PVC-U.

Actuación neumática.

(A1) = a utilizar con portabridas QPV especial no incluido (transforma la válvula de mariposa de 140 en 125)

(A2) = a utilizar con portabridas QPV especial no incluido (transforma la válvula de mariposa de 225 en 200)

(A3)= a utilizar con tubo de diámetro 250 SDR 26 (PN10) * Actuadores de aluminio

Las válvulas neumáticas se configuran NC (normalmente cerrada) de serie.

La configuración NA (normalmente abierta) se debe especificar en el pedido.



K

FKOV/CE

ACTUACIÓN ELÉCTRICA

ACTUACIÓN ELÉCTRICA CON BLOQUE DE SEGURIDAD

d	24-240 V AC/DC		24-240 V AC/DC		24-240 V AC/DC		24-240 V AC/DC	
	Ref.	€ FKM	Ref.	€ FKM	Ref.	€ FKM	Ref.	€ FKM
50	FKVE050E2D	965,17	FKVE050F2D	1.155,45	FKVE050E2BD	1.598,73	FKVE050F2BD	1.789,02
63	FKVE063E2D	985,07	FKVE063F2D	1.186,54	FKVE063E2BD	1.618,62	FKVE063F2BD	1.820,11
75	FKVE075E2D	1.321,40	FKVE075F2D	1.545,29	FKVE075E2BD	1.954,96	FKVE075F2BD	2.178,79
90	FKVE090E2D	1.356,28	FKVE090F2D	1.590,11	FKVE090E2BD	1.989,84	FKVE090F2BD	2.223,63
110	FKVE110E2D	1.392,66	FKVE110F2D	1.644,79	FKVE110E2BD	2.026,23	FKVE110F2BD	2.278,33
125 (A1)	FKVE140E2D	1.964,85	FKVE140F2D	2.306,48	FKVE140E2BD	2.598,38	FKVE140F2BD	2.940,05
140	FKVE140E2D	1.964,85	FKVE140F2D	2.306,48	FKVE140E2BD	2.598,38	FKVE140F2BD	2.940,05
160	FKVE160E2D	2.307,53	FKVE160F2D	2.660,74	FKVE160E2BD	3.048,92	FKVE160F2BD	3.402,13
200(A2)	FKVE225E2D	2.674,17	FKVE225F2D	3.135,22	FKVE225E2BD	3.415,55	FKVE225F2BD	3.876,61
225	FKVE225E2D	2.674,17	FKVE225F2D	3.135,22	FKVE225E2BD	3.415,55	FKVE225F2BD	3.876,61
250(A3)	FKVE280E2D	4.711,65	FKVE280F2D	6.645,62	FKVE280E2BD	5.453,04	FKVE280F2BD	7.386,99
280	FKVE280E2D	4.711,65	FKVE280F2D	6.645,62	FKVE280E2BD	5.453,04	FKVE280F2BD	7.386,99
315	FKVE315E2D	4.968,75	FKVE315F2D	7.076,91	FKVE315E2BD	5.710,15	FKVE315F2BD	7.818,29
355	FKVE355E2D	12.584,11	FKVE355F2D	17.106,22				
400	FKVE400E2D	13.946,94	FKVE400F2D	20.479,44				

Válvula de mariposa industrial motorizada.

Cuerpo en PPGR y disco en PVC-U.

Actuación eléctrica.

(A1) = a utilizar con portabridas QPV especial no incluido (transforma la válvula de mariposa de 140 en 125)

(A2) = a utilizar con portabridas QPV especial no incluido (transforma la válvula de mariposa de 225 en 200)

(A3) = a utilizar con tubo de diámetro 250 SDR 26 (PN10)

Bajo pedido podemos suministrar otros actuadores: VALPES, BELIMO...

Bajo pedido también disponibles en 12V AC/DC



K

FKOV/CP

ACTUACIÓN NEUMÁTICA ALUMINIO

ACTUACIÓN NEUMÁTICA ALUMINIO CON ELECTROVÁLVULA, FINALES DE CARRERA (ELECTROMECAÑICOS) Y REGULADORES DE ESCAPE

d	DOBLE EFECTO		SIMPLE EFECTO		DOBLE EFECTO		SIMPLE EFECTO	
	Ref.	€	Ref.	€	Ref.	€	Ref.	€
50	FKVP050EDED	579,45	FKVP050ESED	682,63	FKVP050EDEFD	808,58	FKVP050ESEFD	923,91
63	FKVP063EDED	599,36	FKVP063ESED	702,52	FKVP063EDEFD	828,49	FKVP063ESEFD	943,78
75	FKVP075EDED	679,95	FKVP075ESED	832,41	FKVP075EDEFD	909,09	FKVP075ESEFD	1.073,65
90	FKVP090EDED	786,27	FKVP090ESED	923,03	FKVP090EDEFD	1.015,43	FKVP090ESEFD	1.164,31
110	FKVP110EDED	822,65	FKVP110ESED	1.337,52	FKVP110EDEFD	1.051,81	FKVP110ESEFD	1.578,78
125 (A1)	FKVP140EDED	1.014,31	FKVP140ESED	1.788,05	FKVP140EDEFD	1.243,49	FKVP140ESEFD	2.029,30
140	FKVP140EDED	1.014,31	FKVP140ESED	1.788,05	FKVP140EDEFD	1.243,49	FKVP140ESEFD	2.029,30
160	FKVP160EDED	1.080,67	FKVP160ESED	1.854,37	FKVP160EDEFD	1.309,82	FKVP160ESEFD	2.095,63
200 (A2)	FKVP225EDED	1.605,98	FKVP225ESED	2.667,86	FKVP225EDEFD	1.835,13	FKVP225ESEFD	2.909,14
225	FKVP225EDED	1.605,98	FKVP225ESED	2.667,86	FKVP225EDEFD	1.835,13	FKVP225ESEFD	2.909,14
250 (A3)	FKVP280EDED	3.850,13	FKVP280ESED	6.101,38	FKVP280EDEFD	4.079,26	FKVP280ESEFD	6.342,66
280	FKVP280EDED	3.850,13	FKVP280ESED	6.101,38	FKVP280EDEFD	4.079,26	FKVP280ESEFD	6.342,66
315	FKVP315EDED	4.413,40	FKVP315ESED	7.521,46	FKVP315EDEFD	4.642,56	FKVP315ESEFD	7.762,72
355	FKVP355EDED	7.179,39	FKVP355ESED	9.521,56				
400	FKVP400EDED	7.929,29	FKVP400ESED	12.385,87				

50	FKVP050FDED	769,73	FKVP050FSED	872,91	FKVP050FDEFD	998,86	FKVP050FSEFD	1.114,17
63	FKVP063FDED	800,82	FKVP063FSED	904,01	FKVP063FDEFD	1.029,95	FKVP063FSEFD	1.145,26
75	FKVP075FDED	903,79	FKVP075FSED	1.056,28	FKVP075FDEFD	1.132,95	FKVP075FSEFD	1.297,53
90	FKVP090FDED	1.020,08	FKVP090FSED	1.156,85	FKVP090FDEFD	1.249,24	FKVP090FSEFD	1.398,10
110	FKVP110FDED	1.074,80	FKVP110FSED	1.589,65	FKVP110FDEFD	1.303,95	FKVP110FSEFD	1.830,91
125 (A1)	FKVP140FDED	1.355,98	FKVP140FSED	2.129,68	FKVP140FDEFD	1.585,11	FKVP140FSEFD	2.370,94
140	FKVP140FDED	1.355,98	FKVP140FSED	2.129,68	FKVP140FDEFD	1.585,11	FKVP140FSEFD	2.370,94
160	FKVP160FDED	1.433,91	FKVP160FSED	2.207,62	FKVP160FDEFD	1.663,06	FKVP160FSEFD	2.448,88
200 (A2)	FKVP225FDED	2.067,06	FKVP225FSED	3.128,95	FKVP225FDEFD	2.296,22	FKVP225FSEFD	3.370,21
225	FKVP225FDED	2.067,06	FKVP225FSED	3.128,95	FKVP225FDEFD	2.296,22	FKVP225FSEFD	3.370,21
250 (A3)	FKVP280FDED	5.784,08	FKVP280FSED	8.035,31	FKVP280FDEFD	6.013,24	FKVP280FSEFD	8.276,58
280	FKVP280FDED	5.784,08	FKVP280FSED	8.035,31	FKVP280FDEFD	6.013,24	FKVP280FSEFD	8.276,58
315	FKVP315FDED	6.521,56	FKVP315FSED	9.629,62	FKVP315FDEFD	6.750,70	FKVP315FSEFD	9.870,86
355	FKVP355FDED	11.701,48	FKVP355FSED	14.043,69				
400	FKVP400FDED	14.461,81	FKVP400FSED	18.918,37				

Válvula de mariposa industrial motorizada.

Cuerpo en PPGR y disco en PVC-U.

Actuación neumática.

(A1) = a utilizar con portabridas QPV especial no incluido (transforma la válvula de mariposa de 140 en 125)

(A2) = a utilizar con portabridas QPV especial no incluido (transforma la válvula de mariposa de 225 en 200)

(A3) = a utilizar con tubo de diámetro 250 SDR 26 (PN10)

Las válvulas neumáticas se configuran NC (normalmente cerrada) de serie. La configuración NA (normalmente abierta) se debe especificar en el pedido.



K

FKOV/CP

ACTUACIÓN NEUMÁTICA POLIAMIDA

ACTUACIÓN NEUMÁTICA POLIAMIDA CON ELECTROVÁLVULA, FINALES DE CARRERA (ELECTROMECAÑICOS) Y REGULADORES DE ESCAPE

d	DOBLE EFECTO		SIMPLE EFECTO		DOBLE EFECTO		SIMPLE EFECTO	
	Ref.	E	Ref.	€	Ref.	€	Ref.	€
50	FKVP050EDEP	701,60	FKVP050ESEP	887,99	FKVP050EDEF	1.001,37	FKVP050ESEFP	1.187,75
63	FKVP063EDEP	721,50	FKVP063ESEP	907,86	FKVP063EDEF	1.021,24	FKVP063ESEFP	1.207,63
75	FKVP075EDEP	761,29	FKVP075ESEP	947,64	FKVP075EDEF	1.061,06	FKVP075ESEFP	1.247,38
90	FKVP090EDEP	906,16	FKVP090ESEP	982,13	FKVP090EDEF	1.205,92	FKVP090ESEFP	1.281,90
110	FKVP110EDEP	942,55	FKVP110ESEP	1.241,51	FKVP110EDEF	1.242,29	FKVP110ESEFP	1.541,29
125 (A1)	FKVP140EDEP	1.087,01	FKVP140ESEP	1.728,81	FKVP140EDEF	1.386,79	FKVP140ESEFP	2.028,58
140	FKVP140EDEP	1.087,01	FKVP140ESEP	1.728,81	FKVP140EDEF	1.386,79	FKVP140ESEFP	2.028,58
160	FKVP160EDEP	1.363,08	FKVP160ESEP	1.795,19	FKVP160EDEF	1.662,85	FKVP160ESEFP	2.094,91
200 (A2)	FKVP225EDEP	1.584,70	FKVP225ESEP	2.476,40	FKVP225EDEF	1.884,47	FKVP225ESEFP	2.776,18
225	FKVP225EDEP	1.584,70	FKVP225ESEP	2.476,40	FKVP225EDEF	1.884,47	FKVP225ESEFP	2.776,18
250*(A3)	FKVP280EDEP	4.054,23	FKVP280ESEP	5.965,72	FKVP280EDEF	4.353,99	FKVP280ESEFP	6.265,47
280*	FKVP280EDEP	4.054,23	FKVP280ESEP	5.965,72	FKVP280EDEF	4.353,99	FKVP280ESEFP	6.265,47
315*	FKVP315EDEP	4.311,31	FKVP315ESEP	6.222,81	FKVP315EDEF	4.611,07	FKVP315ESEFP	6.522,59
355	FKVP355EDEP	Consultar	FKVP355ESEP	Consultar				
400	FKVP400EDEP	Consultar	FKVP400ESEP	Consultar				

50	FKVP050FDEP	891,91	FKVP050FSEP	1.078,26	FKVP050FDEF	1.191,66	FKVP050FSEFP	1.378,03
63	FKVP063FDEP	922,96	FKVP063FSEP	1.109,33	FKVP063FDEF	1.222,73	FKVP063FSEFP	1.409,10
75	FKVP075FDEP	985,13	FKVP075FSEP	1.171,48	FKVP075FDEF	1.284,90	FKVP075FSEFP	1.471,26
90	FKVP090FDEP	1.139,96	FKVP090FSEP	1.215,92	FKVP090FDEF	1.439,72	FKVP090FSEFP	1.515,68
110	FKVP110FDEP	1.194,66	FKVP110FSEP	1.493,63	FKVP110FDEF	1.494,41	FKVP110FSEFP	1.793,39
125 (A1)	FKVP140FDEP	1.428,65	FKVP140FSEP	2.070,47	FKVP140FDEF	1.728,42	FKVP140FSEFP	2.370,21
140	FKVP140FDEP	1.428,65	FKVP140FSEP	2.070,47	FKVP140FDEF	1.728,42	FKVP140FSEFP	2.370,21
160	FKVP160FDEP	1.716,33	FKVP160FSEP	2.148,39	FKVP160FDEF	2.016,08	FKVP160FSEFP	2.448,15
200 (A2)	FKVP225FDEP	2.045,77	FKVP225FSEP	2.937,51	FKVP225FDEF	2.345,54	FKVP225FSEFP	3.237,27
225	FKVP225FDEP	2.045,77	FKVP225FSEP	2.937,51	FKVP225FDEF	2.345,54	FKVP225FSEFP	3.237,27
250*(A3)	FKVP280FDEP	5.988,19	FKVP280FSEP	7.899,69	FKVP280FDEF	6.287,93	FKVP280FSEFP	8.199,45
280*	FKVP280FDEP	5.988,19	FKVP280FSEP	7.899,69	FKVP280FDEF	6.287,93	FKVP280FSEFP	8.199,45
315*	FKVP315FDEP	6.419,47	FKVP315FSEP	8.330,97	FKVP315FDEF	6.719,21	FKVP315FSEFP	8.630,72
355	FKVP355FDEP	Consultar	FKVP355FSEP	Consultar				
400	FKVP400FDEP	Consultar	FKVP400FSEP	Consultar				

Válvula de mariposa industrial motorizada.

Cuerpo en PPGR y disco en PVC-U.

Actuación neumática.

(A1) = a utilizar con portabridas QPV especial no incluido (transforma la válvula de mariposa de 140 en 125)

(A2) = a utilizar con portabridas QPV especial no incluido (transforma la válvula de mariposa de 225 en 200)

(A3)= a utilizar con tubo de diámetro 250 SDR 26 (PN10) * Actuadores de aluminio

Las válvulas neumáticas se configuran NC (normalmente cerrada) de serie.

La configuración NA (normalmente abierta) se debe especificar en el pedido.



INDUSTRIA

Válvulas motorizadas de PVC-U presión

Actuadores y accesorios



Para válvulas de bola 2 vías VKD.



K

ACTUACIÓN ELÉCTRICA
24-240 V AC/DC

ACTUACIÓN NEUMÁTICA ALUMINIO
DOBLE EFECTO SIMPLE EFECTO

ACTUACIÓN NEUMÁTICA POLIAMIDA
DOBLE EFECTO SIMPLE EFECTO

d	Ref. 12 V AC/DC	€	Ref.	€	Ref.	€	Ref.	€	Ref.	€	Ref.	€
16	J4CB20	602,77	J4CS20	602,77	CHC052	193,92	CHC052SR	230,03	PPW	212,92	PPWS	240,41
20	J4CB20	602,77	J4CS20	602,77	CHC052	193,92	CHC052SR	230,03	PPW	212,92	PPWS	240,41
25	J4CB20	602,77	J4CS20	602,77	CHC052	193,92	CHC052SR	230,03	PPW	212,92	PPWS	240,41
32	J4CB20	602,77	J4CS20	602,77	CHC052	193,92	CHC052SR	230,03	PPW	212,92	PP00S	364,04
40	J4CB20	602,77	J4CS20	602,77	CHC052	193,92	CHC052SR	230,03	PPW	212,92	PP00S	364,04
50	J4CB20	602,77	J4CS20	602,77	CHC052	193,92	CHC063SR	297,12	PPW	212,92	PP10S	508,28
63	J4CB20	602,77	J4CS20	602,77	CHC052	193,92	CHC075SR	387,21	PP10	429,27	PP10S	508,28
75	J4CB55	911,20	J4CS55	911,20	CHC075	306,19	CHC083SR	442,94	PP10	429,27	PP20S	721,22
90	J4CB55	911,20	J4CS55	911,20	CHC075	306,19	CHC083SR	442,94	PP10	429,27	PP20S	721,22
110	J4CB85	1.338,70	J4CS85	1.338,70	CHC083	336,80	CHC105SR	821,06	PP10	429,27	PP20S	721,22

Para válvulas de bola 3 vías TKD.

16	J4CB20	602,77	J4CS20	602,77	CHC052	193,92	CHC052SR	230,03	PPW	212,92	PPWS	240,41
20	J4CB20	602,77	J4CS20	602,77	CHC052	193,92	CHC052SR	230,03	PPW	212,92	PPWS	240,41
25	J4CB20	602,77	J4CS20	602,77	CHC052	193,92	CHC052SR	230,03	PPW	212,92	PPWS	240,41
32	J4CB20	602,77	J4CS20	602,77	CHC052	193,92	CHC052SR	230,03	PPW	212,92	PP00S	364,04
40	J4CB20	602,77	J4CS20	602,77	CHC052	193,92	CHC063SR	297,12	PPW	212,92	PP10S	508,28
50	J4CB20	602,77	J4CS20	602,77	CHC063	234,73	CHC075SR	387,21	PP00	326,28	PP10S	508,28
63	J4CB20	602,77	J4CS20	602,77	CHC063	234,73	CHC075SR	387,21	PP10	429,27	PP10S	508,28

Para válvulas de mariposa FE.

50	J4CB20	602,77	J4CS20	602,77	CHC052	193,92	CHC063SR	297,12	PP00	326,28	PP10S	508,28
63	J4CB20	602,77	J4CS20	602,77	CHC052	193,92	CHC063SR	297,12	PP00	326,28	PP10S	508,28
75	J4CB55	911,20	J4CS55	911,20	CHC063	234,73	CHC075SR	387,21	PP00	326,28	PP10S	508,28
90	J4CB55	911,20	J4CS55	911,20	CHC075	306,19	CHC083SR	442,94	PP10	429,27	PP10S	508,28
110	J4CB55	911,20	J4CS55	911,20	CHC075	306,19	CHC105SR	821,06	PP10	429,27	PP20S	721,22
140	J4CB85	1.338,70	J4CS85	1.338,70	CHC083	336,80	CHC125SR	1.110,54	PP10	429,27	PA25S *	1.047,47
160	J4CB140	1.626,20	J4CS140	1.626,20	CHC083	336,80	CHC125SR	1.110,54	PP20	618,17	PA25S *	1.047,47
225	J4CB300	1.766,38	J4CS300	1.766,38	CHC105	632,80	CHC140SR	1.694,74	PP20	618,17	PA30S *	1.545,59
280	J4CB300	1.766,38	J4CS300	1.766,38	CHC125	836,87	CHC190SR	3.088,14	PA30 *	1.184,95	P40ST *	3.235,61
315	J4CB300	1.766,38	J4CS300	1.766,38	CHC140	1.143,08	CHC210SR	4.251,91	PA30 *	1.184,95	P40ST *	3.235,61

Para válvulas de mariposa FK.

50	J4CB20	602,77	J4CS20	602,77	CHC052	193,92	CHC063SR	297,12	PP00	326,28	PP10S	508,28
63	J4CB20	602,77	J4CS20	602,77	CHC052	193,92	CHC063SR	297,12	PP00	326,28	PP10S	508,28
75	J4CB55	911,20	J4CS55	911,20	CHC063	234,73	CHC075SR	387,21	PP00	326,28	PP10S	508,28
90	J4CB55	911,20	J4CS55	911,20	CHC075	306,19	CHC083SR	442,94	PP10	429,27	PP10S	508,28
110	J4CB55	911,20	J4CS55	911,20	CHC075	306,19	CHC105SR	821,06	PP10	429,27	PP20S	721,22
140	J4CB85	1.338,70	J4CS85	1.338,70	CHC083	336,80	CHC125SR	1.110,54	PP10	429,27	PA25S *	1.047,47
160	J4CB140	1.626,20	J4CS140	1.626,20	CHC083	336,80	CHC125SR	1.110,54	PP20	618,17	PA25S *	1.047,47
225	J4CB300	1.766,38	J4CS300	1.766,38	CHC105	632,80	CHC140SR	1.694,74	PP20	618,17	PA30S *	1.545,59
280	J4CB300	1.766,38	J4CS300	1.766,38	CHC125	836,87	CHC190SR	3.088,14	PA30 *	1.184,95	P40ST *	3.235,61
315	J4CB300	1.766,38	J4CS300	1.766,38	CHC140	1.143,08	CHC210SR	4.251,91	PA30 *	1.184,95	P40ST *	3.235,61
355	ITQ-0800-24	Consultar	ITQ-0800-220	Consultar	CHCN160	Consultar	CHCN210SR	Consultar				
400	ITQ-1100-24	Consultar	ITQ-1100-220	Consultar	CHCN160	Consultar	CHCN240SR	Consultar				

* 24V AC/DC ** 80-240V AC/DC La válvula de mariposa de 140 es la misma que la de 125. Lo mismo sucede con la de 225-200 y la de 280- 250 * Actuadores de aluminio

Reductor manual para válvulas de mariposa FE y FK.

50 - 225 **ILG/D-232/10** **911,22**

250 - 315 **ILG/D-550** **1.173,67**



K

Ref.	Modelo	€
BSR2017	Para válvulas de bola \varnothing 16 - 63 mm.	633,56
BSR2017	Para válvulas de bola \varnothing 75 - 90 y mariposa \varnothing 50 - 110 mm.	633,56
BSR2005	Para válvulas de bola \varnothing 110 mm. y mariposa \varnothing 140 - 315 mm.	741,39
BSR2017	Para válvulas de bola 3 vías \varnothing 16 - 63 mm.	633,56

Bloque de seguridad.

Importe a añadir al precio del actuador.

Para válvulas con actuador [eléctrico J+J](#).

K

Ref.	Modelo	€
DPS2017	Para válvulas de bola \varnothing 16 - 63 mm.	545,94
DPS2017	Para válvulas de bola \varnothing 75 - 90 y mariposa \varnothing 50 - 110 mm.	545,94
DPS2005	Para válvulas de bola \varnothing 110 mm. y mariposa \varnothing 140 - 315 mm.	963,81
DPS2017	Para válvulas de bola 3 vías \varnothing 16 - 63 mm.	545,94

Posicionador 4-20 mA.

Importe a añadir al precio del actuador.

Para válvulas con actuador [eléctrico J+J](#).

K

Ref.	Modelo	Vías	Voltaje	€
EJ024CA-2008	Electroválvula J+J 2008	5/2	24 V CA	121,31
EJ024CC-2008	Electroválvula J+J 2008	5/2	24 V CC	121,31
EJ048CA-2008	Electroválvula J+J 2008	5/2	48 V CA	121,31
EJ110CA-2008	Electroválvula J+J 2008	5/2	110 V CA	121,31
EJ220CA-2008	Electroválvula J+J 2008	5/2	220V CA	121,31

Electroválvula.

3/2 vías consultar.

Para válvulas con actuador [neumático CH-AIR](#).

K

Ref.	Modelo	€
CB2GC00TAPSS	2 finales de carrera ELECTROMECAÑICOS	107,84

Caja final de carrera electromecánico.

Los precios ya incluyen la instalación y montaje sobre el actuador

Para válvulas con actuador [neumático CH-AIR](#).



K

Ref.	Modelo	€
CB2GP23TAPSS	2 finales de carrera INDUCTIVOS NBB2-V3-E2 3 hilos PNP	350,49
CB2GP41TAPSS	2 finales de carrera INDUCTIVOS NBB2-V3-E0 3 hilos NPN	350,49
CB2GP49TAPS	2 finales de carrera INDUCTIVOS NBB2-V3-Z4 2 hilos no	377,43

Caja final de carrera electromecánico.

Para válvulas con actuador *neumático CH-AIR*.

Los precios ya incluyen la instalación y montaje sobre el actuador

YT-1200



YT-1000



YT-2300



K

Ref.	Modelo	€
YT-1200	Posicionador neumático 3-15 PSI	1.422,11
YT-1000	Posicionador electroneumático 4-20 mA	2.102,86
YT-2300	Posicionador electroneumático 4-20 mA + FEEDBACK 4-20 mA	3.848,48

Posicionador.

Para válvulas con actuador *neumático CH-AIR*.

Los precios ya incluyen la instalación y montaje sobre el actuador



K

Ref.	Modelo	Vias	Voltaje	€
EV-500.024A	Electroválvula PRISMA NAMUR	3/2 -5/2	24 V CA	147,64
EV-500.024C	Electroválvula PRISMA NAMUR	3/2 -5/2	24 V CC	147,64
EV-500.048A	Electroválvula PRISMA NAMUR	3/2 -5/2	48 V CA	147,64
EV-500.110A	Electroválvula PRISMA NAMUR	3/2 -5/2	110 V CA	147,64
EV-500.220A	Electroválvula PRISMA NAMUR	3/2 -5/2	220V CA	147,64

Electroválvula.

Para válvulas con actuador *neumático PRISMA*.

K

Ref.	Modelo	€
CFC-5601	2 finales de carrera ELECTROMECAÑICOS	128,98
CFC-5603	4 finales de carrera ELECTROMECAÑICOS	238,43

Caja final de carrera electromecánico **aluminio**.Para válvulas con actuador *neumático PRISMA*.

Los precios ya incluyen la instalación y montaje sobre el actuador.



K

Ref.	Modelo	€
CFC-5202	2 finales de carrera INDUCTIVOS NAMUR EEXI P+F	374,15
CFC-5204	2 finales de carrera INDUCTIVOS NPN P+F	743,67
CFC-5206	2 finales de carrera INDUCTIVOS PNP P+F	464,99

Caja final de carrera inductivo **aluminio**.
Para válvulas con actuador **neumático PRISMA**.

Los precios ya incluyen la instalación y montaje sobre el actuador.



K

Ref.	Modelo	€
CFC-6301	2 finales de carrera ELECTROMECAÑICOS	169,54
CFC-6302	4 finales de carrera ELECTROMECAÑICOS rec. ORO	170,98

Caja final de carrera electromecánico **plástico**.
Para válvulas con actuador **neumático PRISMA**.

Los precios ya incluyen la instalación y montaje sobre el actuador.



K

Ref.	Modelo	€
CFC-6321	1 final de carrera INDUCTIVO P+F NBB2-V3-E2 (PNP)	306,92
CFC-6322	2 finales de carrera INDUCTIVOS P+F NBB2-V3-E2 (PNP)	414,50

Caja final de carrera inductivo **plástico**.
Para válvulas con actuador **neumático PRISMA**.

Los precios ya incluyen la instalación y montaje sobre el actuador.

PST-001



PST-003



PST-003



K

Ref.	Modelo	€
PST-001	Posicionador electroneumático 4-20 mA	1.780,96
PST-002	Posicionador electroneumático 4-20 mA + 2 finales de carrera SPDT	2.239,48
PST-003	Posicionador electroneumático 4-20 mA + 2 finales de carrera SPDT + FEEDBACK 4-20 mA	3.349,88

Posicionador.

Para válvulas con actuador **neumático PRISMA**.

Los precios ya incluyen la instalación y montaje sobre el actuador.



INDUSTRIA

Válvulas motorizadas de PVC-U presión

Válvulas de membrana actuadas



DK/CP NC				VM/CP NC				L
d	Modelo	DN	Ref. EPDM	€ EPDM	Ref. FKM	€ FKM	Ref. PTFE	€ PTFE
20	DKDV/CP NC	15	DKDVNC020E	267,92	DKDVNC020F	313,76	DKDVNC020P	332,77
25	DKDV/CP NC	20	DKDVNC025E	281,29	DKDVNC025F	329,00	DKDVNC025P	348,99
32	DKDV/CP NC	25	DKDVNC032E	344,44	DKDVNC032F	401,64	DKDVNC032P	424,08
40	DKDV/CP NC	32	DKDVNC040E	458,86	DKDVNC040F	553,07	DKDVNC040P	577,79
50	DKDV/CP NC	40	DKDVNC050E	520,67	DKDVNC050F	622,58	DKDVNC050P	650,50
63	DKDV/CP NC	50	DKDVNC063E	729,38	DKDVNC063F	902,91	DKDVNC063P	898,08
75	DKDV/CP NC	65	DKDVNC075E	875,24	DKDVNC075F	1.083,50	DKDVNC075P	1.077,71
90	VMDV/CP NC	80	VMDVNC090E	1.338,30	VMDVNC090F	1.783,74	VMDVNC090P	1.547,02
110	VMDV/CP NC	100	VMDVNC110E	1.654,55	VMDVNC110F	2.079,31	VMDVNC110P	1.851,83

Válvula neumática **NORMALMENTE CERRADA.**

M-M encolar

DK/CP NO				VM/CP NO				L
d	Modelo	DN	Ref. EPDM	€ EPDM	Ref. FKM	€ FKM	Ref. PTFE	€ PTFE
20	DKDV/CP NO	15	DKDVNO020E	219,82	DKDVNO020F	265,64	DKDVNO020P	284,70
25	DKDV/CP NO	20	DKDVNO025E	233,18	DKDVNO025F	280,88	DKDVNO025P	300,88
32	DKDV/CP NO	25	DKDVNO032E	290,47	DKDVNO032F	375,09	DKDVNO032P	400,96
40	DKDV/CP NO	32	DKDVNO040E	302,39	DKDVNO040F	423,91	DKDVNO040P	455,71
50	DKDV/CP NO	40	DKDVNO050E	355,28	DKDVNO050F	485,18	DKDVNO050P	521,16
63	DKDV/CP NO	50	DKDVNO063E	458,57	DKDVNO063F	677,67	DKDVNO063P	671,40
75	DKDV/CP NO	65	DKDVNO075E	550,28	DKDVNO075F	813,20	DKDVNO075P	805,66
90	VMDV/CP NO	80	VMDVNO090E	892,97	VMDVNO090F	1.419,05	VMDVNO090P	1.138,94
110	VMDV/CP NO	100	VMDVNO110E	1.359,35	VMDVNO110F	1.926,38	VMDVNO110P	1.600,28

Válvula neumática **NORMALMENTE ABIERTA.**

M-M encolar

DK/CP DE				VM/CP DE				L
d	Modelo	DN	Ref. EPDM	€ EPDM	Ref. FKM	€ FKM	Ref. PTFE	€ PTFE
20	DKDV/CP DE	15	DKDVDA020E	171,73	DKDVDA020F	217,55	DKDVDA020P	236,59
25	DKDV/CP DE	20	DKDVDA025E	185,10	DKDVDA025F	232,81	DKDVDA025P	252,81
32	DKDV/CP DE	25	DKDVDA032E	252,66	DKDVDA032F	331,78	DKDVDA032P	356,22
40	DKDV/CP DE	32	DKDVDA040E	274,88	DKDVDA040F	385,36	DKDVDA040P	414,28
50	DKDV/CP DE	40	DKDVDA050E	235,06	DKDVDA050F	321,01	DKDVDA050P	344,83
63	DKDV/CP DE	50	DKDVDA063E	303,41	DKDVDA063F	448,36	DKDVDA063P	444,21
75	DKDV/CP DE	65	DKDVDA075E	364,07	DKDVDA075F	538,05	DKDVDA075P	533,05
90	VMDV/CP DE	80	VMDVDA090E	1.114,43	VMDVDA090F	1.640,51	VMDVDA090P	1.360,37
110	VMDV/CP DE	100	VMDVDA110E	1.571,93	VMDVDA110F	1.983,97	VMDVDA110P	1.812,83

Válvula neumática **DOBLE EFECTO.**

M-M encolar

DK/CP NC



d	Modelo	DN	Ref. EPDM	€ EPDM	Ref. FKM	€ FKM	Ref. PTFE	€ PTFE
20	DKUIV/CP NC	15	DKUIVNC020E	268,94	DKUIVNC020F	327,05	DKUIVNC020P	350,92
25	DKUIV/CP NC	20	DKUIVNC025E	284,16	DKUIVNC025F	337,57	DKUIVNC025P	370,02
32	DKUIV/CP NC	25	DKUIVNC032E	351,16	DKUIVNC032F	426,33	DKUIVNC032P	454,36
40	DKUIV/CP NC	32	DKUIVNC040E	466,71	DKUIVNC040F	585,60	DKUIVNC040P	614,79
50	DKUIV/CP NC	40	DKUIVNC050E	540,07	DKUIVNC050F	673,55	DKUIVNC050P	707,51
63	DKUIV/CP NC	50	DKUIVNC063E	750,06	DKUIVNC063F	962,40	DKUIVNC063P	956,64

Válvula neumática **NORMALMENTE CERRADA.**

Con enlaces H-H para encolar.

DK/CP NO



d	Modelo	DN	Ref. EPDM	€ EPDM	Ref. FKM	€ FKM	Ref. PTFE	€ PTFE
20	DKUIV/CP NO	15	DKUIVNO020E	220,84	DKUIVNO020F	278,95	DKUIVNO020P	302,83
25	DKUIV/CP NO	20	DKUIVNO025E	236,08	DKUIVNO025F	289,47	DKUIVNO025P	321,92
32	DKUIV/CP NO	25	DKUIVNO032E	309,24	DKUIVNO032F	401,78	DKUIVNO032P	366,00
40	DKUIV/CP NO	32	DKUIVNO040E	337,07	DKUIVNO040F	468,73	DKUIVNO040P	506,36
50	DKUIV/CP NO	40	DKUIVNO050E	408,51	DKUIVNO050F	558,76	DKUIVNO050P	601,00
63	DKUIV/CP NO	50	DKUIVNO063E	527,27	DKUIVNO063F	768,44	DKUIVNO063P	760,62

Válvula neumática **NORMALMENTE ABIERTA.**

Con enlaces H-H para encolar.

DK/CP DE



d	Modelo	DN	Ref. EPDM	€ EPDM	Ref. FKM	€ FKM	Ref. PTFE	€ PTFE
20	DKUIV/CP DE	15	DKUIVDA020E	172,76	DKUIVDA020F	230,86	DKUIVDA020P	254,74
25	DKUIV/CP DE	20	DKUIVDA025E	187,98	DKUIVDA025F	241,38	DKUIVDA025P	273,80
32	DKUIV/CP DE	25	DKUIVDA032E	269,90	DKUIVDA032F	356,40	DKUIVDA032P	389,74
40	DKUIV/CP DE	32	DKUIVDA040E	306,44	DKUIVDA040F	426,10	DKUIVDA040P	460,31
50	DKUIV/CP DE	40	DKUIVDA050E	371,37	DKUIVDA050F	507,95	DKUIVDA050P	671,18
63	DKUIV/CP DE	50	DKUIVDA063E	479,31	DKUIVDA063F	698,59	DKUIVDA063P	691,47

Válvula neumática **DOBLE EFECTO.**

Con enlaces H-H para encolar.

DK/CP NC



Rh	Modelo	DN	Ref. EPDM	€ EPDM	Ref. FKM	€ FKM	Ref. PTFE	€ PTFE
1/2"	DKUFV/CP NC	15	DKUFVNC012E	268,94	DKUFVNC012F	327,05	DKUFVNC012P	350,92
3/4"	DKUFV/CP NC	20	DKUFVNC034E	284,16	DKUFVNC034F	337,57	DKUFVNC034P	370,02
1"	DKUFV/CP NC	25	DKUFVNC100E	351,16	DKUFVNC100F	426,33	DKUFVNC100P	454,36
1 1/4"	DKUFV/CP NC	32	DKUFVNC114E	466,71	DKUFVNC114F	585,60	DKUFVNC114P	614,79
1 1/2"	DKUFV/CP NC	40	DKUFVNC112E	540,07	DKUFVNC112F	673,55	DKUFVNC112P	707,51
2"	DKUFV/CP NC	50	DKUFVNC200E	734,66	DKUFVNC200F	962,40	DKUFVNC200P	956,64

Válvula neumática **NORMALMENTE CERRADA.**

Con enlaces H-H para rosca.

DK/CP NO



d	Modelo	DN	Ref. EPDM	€ EPDM	Ref. FKM	€ FKM	Ref. PTFE	€ PTFE
1/2"	DKUFV/CP NO	15	DKUFVNO012E	220,84	DKUFVNO012F	278,95	DKUFVNO012P	302,83
3/4"	DKUFV/CP NO	20	DKUFVNO034E	236,08	DKUFVNO034F	289,47	DKUFVNO034P	321,92
1"	DKUFV/CP NO	25	DKUFVNO100E	309,24	DKUFVNO100F	401,78	DKUFVNO100P	366,00
1 1/4"	DKUFV/CP NO	32	DKUFVNO114E	337,07	DKUFVNO114F	468,73	DKUFVNO114P	506,36
1 1/2"	DKUFV/CP NO	40	DKUFVNO112E	408,51	DKUFVNO112F	558,76	DKUFVNO112P	601,00
2"	DKUFV/CP NO	50	DKUFVNO200E	527,27	DKUFVNO200F	768,44	DKUFVNO200P	760,62

Válvula neumática **NORMALMENTE ABIERTA.**

Con enlaces H-H para rosca.



DK/CP DE



d	Modelo	DN	Ref. EPDM	€ EPDM	Ref. FKM	€ FKM	Ref. PTFE	€ PTFE
1/2"	DKUFV/CP DE	15	DKUFVDA012E	172,76	DKUFVDA012F	230,86	DKUFVDA012P	254,74
3/4"	DKUFV/CP DE	20	DKUFVDA034E	187,98	DKUFVDA034F	241,38	DKUFVDA034P	273,80
1"	DKUFV/CP DE	25	DKUFVDA100E	269,90	DKUFVDA100F	356,40	DKUFVDA100P	389,74
1 1/4"	DKUFV/CP DE	32	DKUFVDA114E	306,44	DKUFVDA114F	426,10	DKUFVDA114P	460,31
1 1/2"	DKUFV/CP DE	40	DKUFVDA112E	371,37	DKUFVDA112F	507,95	DKUFVDA112P	546,37
2"	DKUFV/CP DE	50	DKUFVDA200E	479,31	DKUFVDA200F	698,59	DKUFVDA200P	691,47

Válvula neumática **DOBLE EFECTO.**



Con enlaces H-H para rosca.

DK/CP NC 					VM/CP NC 				L
d	Modelo	DN	Ref. EPDM	€ EPDM	Ref. FKM	€ FKM	Ref. PTFE	€ PTFE	
20	DKOV/CP NC	15	DKOVNC020E	308,12	DKOVNC020F	353,91	DKOVNC020P	372,98	
25	DKOV/CP NC	20	DKOVNC025E	323,48	DKOVNC025F	371,18	DKOVNC025P	391,18	
32	DKOV/CP NC	25	DKOVNC032E	396,12	DKOVNC032F	453,30	DKOVNC032P	475,71	
40	DKOV/CP NC	32	DKOVNC040E	527,70	DKOVNC040F	621,87	DKOVNC040P	646,61	
50	DKOV/CP NC	40	DKOVNC050E	598,79	DKOVNC050F	700,72	DKOVNC050P	728,61	
63	DKOV/CP NC	50	DKOVNC063E	838,80	DKOVNC063F	1.012,35	DKOVNC063P	1.007,50	
75	DKOV/CP NC	65	DKOVNC075E	1.006,56	DKOVNC075F	1.214,82	DKOVNC075P	1.209,00	
90	VMOV/CP NC	80	VMOVNC090E	1.539,10	VMOVNC090F	1.984,46	VMOVNC090P	1.747,77	
110	VMOV/CP NC	100	VMOVNC110E	1.902,76	VMOVNC110F	2.326,75	VMOVNC110P	2.099,82	

 Válvula neumática **NORMALMENTE CERRADA.**

Con bridas DIN.



Disponibles con bridas ANSI 150 libras al mismo precio

DK/CP NO 					VM/CP NO 				L
d	Modelo	DN	Ref. EPDM	€ EPDM	Ref. FKM	€ FKM	Ref. PTFE	€ PTFE	
20	DKOV/CP NO	15	DKOVNO020E	260,00	DKOVNO020F	305,79	DKOVNO020P	324,89	
25	DKOV/CP NO	20	DKOVNO025E	275,39	DKOVNO025F	323,08	DKOVNO025P	343,10	
32	DKOV/CP NO	25	DKOVNO032E	349,42	DKOVNO032F	434,00	DKOVNO032P	377,99	
40	DKOV/CP NO	32	DKOVNO040E	378,09	DKOVNO040F	499,58	DKOVNO040P	531,38	
50	DKOV/CP NO	40	DKOVNO050E	441,20	DKOVNO050F	571,13	DKOVNO050P	607,09	
63	DKOV/CP NO	50	DKOVNO063E	578,93	DKOVNO063F	798,03	DKOVNO063P	791,76	
75	DKOV/CP NO	65	DKOVNO075E	694,72	DKOVNO075F	957,63	DKOVNO075P	950,11	
90	VMOV/CP NO	80	VMOVNO090E	1.093,73	VMOVNO090F	1.619,82	VMOVNO090P	1.339,66	
110	VMOV/CP NO	100	VMOVNO110E	1.547,26	VMOVNO110F	2.102,58	VMOVNO110P	1.788,24	

 Válvula neumática **NORMALMENTE ABIERTA.**

Con bridas DIN.

Disponibles con bridas ANSI 150 libras al mismo precio

DK/CP DE 					VM/CP DE 				L
d	Modelo	DN	Ref. EPDM	€ EPDM	Ref. FKM	€ FKM	Ref. PTFE	€ PTFE	
20	DKOV/CP DE	15	DKOVDA020E	211,92	DKOVDA020F	257,72	DKOVDA020P	276,80	
25	DKOV/CP DE	20	DKOVDA025E	227,29	DKOVDA025F	274,99	DKOVDA025P	294,99	
32	DKOV/CP DE	25	DKOVDA032E	308,19	DKOVDA032F	387,27	DKOVDA032P	411,72	
40	DKOV/CP DE	32	DKOVDA040E	343,72	DKOVDA040F	454,18	DKOVDA040P	483,08	
50	DKOV/CP DE	40	DKOVDA050E	401,10	DKOVDA050F	519,22	DKOVDA050P	519,22	
63	DKOV/CP DE	50	DKOVDA063E	526,31	DKOVDA063F	725,49	DKOVDA063P	725,49	
75	DKOV/CP DE	65	DKOVDA075E	631,55	DKOVDA075F	870,59	DKOVDA075P	870,59	
90	VMOV/CP DE	80	VMOVDA090E	1.315,19	VMOVDA090F	1.841,28	VMOVDA090P	1.561,08	
110	VMOV/CP DE	100	VMOVDA110E	1.759,85	VMOVDA110F	2.148,40	VMOVDA110P	2.000,77	

 Válvula neumática **DOBLE EFECTO.**

Con bridas DIN.

Disponibles con bridas ANSI 150 libras al mismo precio

CMDV/CP NC M-M encolar.
CMIV/CP NC H-H encolar.
CMUIV/CP NC H-H enlaces encolar.
CMFV/CP NC H-H roscar.



L

d-Rh	Ref. EPDM	DN	€ EPDM	€ FKM	€ PTFE
20	CMDVNC020E	15	128,98	146,96	162,65
16	CMIVNC016E	12	121,16	143,61	153,68
20	CMIVNC020E	15	121,16	143,61	153,68
20-1/2"	CMUIVNC020E	15	166,06	182,88 (A)	197,43
3/8"	CMFVNC038E	12	121,16	143,61	153,68
1/2"	CMFVNC012E	15	121,16	143,61	153,68

Válvula de membrana compacta neumática
NORMALMENTE CERRADA

Código en FKM termina en "F" en lugar de "E"
 Código en PTFE termina en "P" en lugar de "E"
 (A) = Juntas en FKM

CMDV/CP NO M-M encolar.
CMIV/CP NO H-H encolar.
CMUIV/CP NO H-H enlaces encolar.
CMFV/CP NO H-H roscar.



L

d-Rh	Ref. EPDM	DN	€ EPDM	€ FKM	€ PTFE
20	CMDVNO020E	15	126,76	144,71	159,32
16	CMIVNO016E	12	120,06	139,11	151,42
20	CMIVNO020E	15	120,06	139,11	151,42
20-1/2"	CMUIVNO020E	15	164,93	179,50 (A)	195,20
3/8"	CMFVNO038E	12	120,06	139,11	151,42
1/2"	CMFVNO012E	15	120,06	139,11	151,42

Válvula de membrana compacta neumática
NORMALMENTE ABIERTA

Código en FKM termina en "F" en lugar de "E"
 Código en PTFE termina en "P" en lugar de "E"
 (A) = Juntas en FKM

CMDV/CP DE M-M encolar.
CMIV/CP DE H-H encolar.
CMUIV/CP DE H-H enlaces encolar.
CMFV/CP DE H-H roscar.



L

d-Rh	Ref. EPDM	DN	€ EPDM	€ FKM	€ PTFE
20	CMDVDA020E	15	126,76	144,71	159,32
16	CMIVDA016E	12	120,06	139,11	151,42
20	CMIVDA020E	15	120,06	139,11	151,42
20-1/2"	CMUIVDA020E	15	164,93	179,50 (A)	195,20
3/8"	CMFVDA038E	12	120,06	139,11	151,42
1/2"	CMFVDA012E	15	120,06	139,11	151,42

Válvula de membrana compacta neumática
DOBLE EFECTO

Código en FKM termina en "F" en lugar de "E"
 Código en PTFE termina en "P" en lugar de "E"
 (A) = Juntas en FKM

DKDDV/CP NO



L

d	Ref. EPDM	DN	PN	€ EPDM
20	DKDDVNO020E	15	8	74,00
25	DKDDVNO025E	20	8	86,39
32	DKDDVNO032E	25	8	95,36
40	DKDDVNO040E	32	8	109,93
50	DKDDVNO050E	40	8	134,59
63	DKDDVNO063E	50	8	144,71
75	DKDDVNO075E	65	8	173,65

Válvula de membrana normalmente abierta acción directa.

Disponible embridada
 Precios: Consultar

Membrana en EPDM. M-M encolar.

DKDUIV/CP NO



L

d	Ref. EPDM	DN	PN	€ EPDM
20	DKDUIVNO020E	15	8	87,49
25	DKDUIVNO025E	20	8	100,94
32	DKDUIVNO032E	25	8	114,44
40	DKDUIVNO040E	32	8	136,90
50	DKDUIVNO050E	40	8	182,97
63	DKDUIVNO063E	50	8	188,43

Válvula de membrana normalmente abierta acción directa.
 Membrana en EPDM. H-H enlaces encolar.

DKDUFV/CP NO



L

Rh	Ref. EPDM	DN	PN	€ EPDM
1/2"	DKDUFVNO012E	15	8	95,36
3/4"	DKDUFVNO034E	20	8	108,83
1"	DKDUFVNO100E	25	8	124,51
1 1/4"	DKDUFVNO114E	32	8	160,41
1 1/2"	DKDUFVNO112E	40	8	197,43
2"	DKDUFVNO200E	50	8	216,52

Válvula de membrana normalmente abierta acción directa.
 Membrana en EPDM. H-H enlaces roscar.

**DKBDV/CP NC**

L

d	Ref. EPDM	DN	PN	€ EPDM
20	DKBDVNC020E	15	6	249,26
25	DKBDVNC025E	20	6	261,72
32	DKBDVNC032E	25	6	325,56
40	DKBDVNC040E	32	6	409,64
50	DKBDVNC050E	40	6	429,70
63	DKBDVNC063E	50	6	601,91
75	DKBDVNC075E	65	6	722,30

Válvula de membrana neumática

Actuador a pistón

Normalmente Cerrada.

M-M encolar.

**DKBUIV/CP NC**

L

d	Ref. EPDM	DN	PN	€ EPDM
20	DKBUIVNC020E	15	6	250,21
25	DKBUIVNC025E	20	6	264,37
32	DKBUIVNC032E	25	6	331,91
40	DKBUIVNC040E	32	6	416,67
50	DKBUIVNC050E	40	6	445,66
63	DKBUIVNC063E	50	6	618,94

Válvula de membrana neumática

Actuador a pistón

Normalmente Cerrada.

Con enlaces H-H encolar.

**DKBUFV/CP NC**

L

Rh	Ref. EPDM	DN	PN	€ EPDM
1/2"	DKBUFVNC012E	15	6	250,21
3/4"	DKBUFVNC034E	20	6	264,37
1"	DKBUFVNC100E	25	6	331,91
1 1/4"	DKBUFVNC114E	32	6	416,67
1 1/2"	DKBUFVNC112E	40	6	445,66
2"	DKBUFVNC200E	50	6	618,94

Válvula de membrana neumática

Actuador a pistón

Normalmente Cerrada.

Con enlaces H-H para roscar.

**DKBOV/CP NC**

L

d	Ref. EPDM	DN	PN	€ EPDM
20	DKBOVNC020E	15	6	286,67
25	DKBOVNC025E	20	6	300,95
32	DKBOVNC032E	25	6	381,45
40	DKBOVNC040E	32	6	484,08
50	DKBOVNC050E	40	6	507,78
63	DKBOVNC063E	50	6	711,35
75	DKBOVNC075E	65	6	924,76

Válvula de membrana neumática

Actuador a pistón

Normalmente Cerrada.

Con bridas DIN.

**DKBOAV/CP NC**

L

d	Ref. EPDM	DN	PN	€ EPDM
1/2"	DKBOAVNC012E	15	6	286,67
3/4"	DKBOAVNC034E	20	6	300,95
1"	DKBOAVNC100E	25	6	381,44
1 1/4"	DKBOAVNC114E	32	6	484,08
1 1/2"	DKBOAVNC112E	40	6	507,78
2"	DKBOAVNC200E	50	6	711,36
2 1/2"	DKBOAVNC212E	65	6	924,76

Válvula de membrana neumática

Actuador a pistón

Normalmente Cerrada.

Con bridas ANSI 150 lbs.



INDUSTRIA

Válvulas motorizadas de PVC-U presión

Accesorios válvulas de membrana



M

DN	Ref.	Tipo de válvula	€
80÷100	ZIN005	VM/CP NC-NO-DE	13,37

Indicador óptico de posición.
Con junta y tapón protector.



M

DN	Ref.	Tipo de válvula	€
40	ZLP001	DKM/CP NC	45,86
50÷65	ZLP002	DKM/CP NC	70,35
40÷65	ZLP003	DKM/CP NO-DE	45,86
80÷100		VM/CP NO-DE *	
12÷15	ZLP005	CM/CP NC-NO-DE	78,14
80÷100		VM/CP NC *	

Limitador de carrera.
Con junta y tapón protector.

* Montaje en fábrica



M

DN	Ref.	Tipo de válvula	€
15÷32	ZLI001	DK/CP NC	70,65
15÷32	ZLI002	DK/CP NO-DE	62,97
40÷65	ZLI003	DK/CP NC	80,10
40÷65	ZLI103	DK/CP NO-DE	62,97
12÷15	ZLI010	CM/CP NC-NO-DE	87,83
80÷100		VM/CP NC-NO *	

Limitador de carrera con indicador óptico de posición.
Con junta y tapón protector.

* Montaje en fábrica



M

DN	Ref.	Tipo de válvula	€
15÷32	ZLIM001	DK/CP NC	76,36
15÷32	ZLIM002	DK/CP NO-DE	87,01
40÷65	ZLIM003	DK/CP NC	76,36
40÷65	ZLIM004	DK/CP NO-DE	76,36

Limitador de carrera con indicador óptico de posición.

Con junta y tapón protector.

Apertura manual
(Montaje en fábrica)



M

DN	Ref.	Tipo de válvula	€
15÷65	ZMSMEC001	DK/CP NC-NO-DE	309,06
80÷100	ZMSMEC004	VM/CP NC	309,06
80	ZMSMEC005	VM/CP NO-DE	332,00
100	ZMSMEC006	VM/CP NO-DE	342,52

Caja micro contactos.
IP65. 2 Conectores electromecánicos.



M

DN	Ref.	Tipo de válvula	€
15÷65	ZMSNAM001	DK/CP NC-NO-DE	503,79
80÷100	ZMSNAM004	VM/CP NC	528,65
80	ZMSNAM005	VM/CP NO-DE	528,65
100	ZMSNAM006	VM/CP NO-DE	1.032,81

Caja micro contactos.
IP65. Seguridad: Eex ia IIC T6.
2 Conectores inductivos NAMUR.



M

DN	Ref.	Tipo de válvula	€
15÷65	ZMSPNP001	DK/CP NC-NO-DE	856,22
80÷100	ZMSPNP004	VM/CP NC	885,77
80	ZMSPNP005	VM/CP NO-DE	885,77
100	ZMSPNP006	VM/CP NO-DE	1.032,81

Caja micro contactos.
IP65. 2 Sensores (3 hilos) NAMUR.



M

DN	Ref.	Tipo de válvula	€
12÷15	ZMSMECCM	CM/CP NC-NO-DE	267,14

Caja micro contactos.
IP65. 2 Conectores electromecánicos.

12÷15	ZMSNAMCM	CM/CP NC-NO-DE	610,60
-------	-----------------	----------------	---------------

Caja micro contactos.
IP65. Seguridad: Eex ia IIC T6.
2 Conectores inductivos NAMUR.



M

DN	Ref.	Tipo de válvula	€
15÷32	ZMSMECLIM001	DK/CP NC	397,57
40	ZMSMECLIM002	DK/CP NC	397,57
50÷65	ZMSMECLIM003	DK/CP NC	397,57
80	ZMSMECLIM005	VM/CP NC	397,57
100	ZMSMECLIM006	VM/CP NC	397,57

Caja micro contactos.
IP65. 2 Conectores electromecánicos.
Con limitador de carrera.



M

DN	Ref.	Tipo de válvula	€
15÷32	ZMSNAMLIM001	DK/CP NC	565,97
40	ZMSNAMLIM002	DK/CP NC	565,97
50÷65	ZMSNAMLIM003	DK/CP NC	565,97
80	ZMSNAMLIM005	VM/CP NC	656,44
100	ZMSNAMLIM006	VM/CP NC	565,97

Caja micro contactos.
IP65. Seguridad: Eex ia IIC T6. 2 Conectores inductivos NAMUR.
Con limitador de carrera.



M

DN	Ref.	Tipo de válvula	€
15÷32	ZMSPNPLIM001	DK/CP NC	954,55
40	ZMSPNPLIM002	DK/CP NC	954,55
50÷65	ZMSPNPLIM003	DK/CP NC	954,55
80	ZMSPNPLIM005	VM/CP NC	1.098,98
100	ZMSPNPLIM006	VM/CP NC	954,55

Caja micro contactos.

IP65. 2 Sensores inductivos PNP 3 hilos.

Con limitador de carrera.



M

DN	Ref.	Tipo de válvula	€
15÷32	ZMSFC001	DK/CP NC	49,62
40÷65	ZMSFC002	DK/CP NC	49,62
80÷100	ZMSFC005	VM/CP NC	49,62
12÷15	ZMSFC009	CM/CP NC-NO-DE	49,62

Caja micro contactos (24.90).

IP65. 1 Conector electromecánico.



M

DN	Ref.	Tipo de válvula	€
15÷65		DK/CP NC-NO*	1.813,21
80÷100		VM/CP NC-NO*	1.813,21

Posicionador electroneumático.

* Montaje en fábrica

SIMPLE EFECTO.

Señal input 4-20 mA. Para válvulas NC-NO.



M

DN	Ref.	Tipo de válvula	€
15÷65		DK/CP DE*	2.236,45
80÷100		VM/CP DE*	2.236,45

Posicionador electroneumático.

* Montaje en fábrica

SIMPLE EFECTO.

Señal input 4-20 mA. Para válvulas DE.



M

DN	Ref.	Tipo de válvula	€
15÷65	ZMS001	DK/CP NC-NO-DE	434,65
80÷100	ZMS001	VM/CP NC	434,65
12÷15	ZMS001	CM/CP NC-NO-DE	434,65
	ZMS002		434,65

Caja micro contactos libres.

IP67. 2 Sensores libres.

Ref.	Cable conexión	€
3CNZMS	5 metros	33,39

Conector "5 conectores" PIN M12 x 1

Para contactos libres ZMS001/2



M

Ref.	Tipo de válvula	€
SPNC14N024DC	DK-DKB-DKD-VM-CM/CP Voltaje 24V DC	146,30
SPNC14N024AC	DK-DKB-DKD-VM-CM/CP Voltaje 24V AC 50 Hz	146,30
SPNC14N110AC	DK-DKB-DKD-VM-CM/CP Voltaje 110V AC 50 Hz	146,30
SPNC14N220AC	DK-DKB-DKD-VM-CM/CP Voltaje 220V AC 50 Hz	146,30

Válvula piloto SP/NC normalmente cerrada.

Juntas NBR. 3/2 vías.

Rosca H 1/4". Montaje directo.



M

Ref.	Tipo de válvula	€
SBNC18N024DC	DK-DKB-DKD-VM-CM/CP Voltaje 24V DC	132,66
SBNC18N024AC	DK-DKB-DKD-VM-CM/CP Voltaje 24V AC 50 Hz	132,66
SBNC18N110AC	DK-DKB-DKD-VM-CM/CP Voltaje 110V AC 50 Hz	132,66
SBNC18N220AC	DK-DKB-DKD-VM-CM/CP Voltaje 220V AC 50 Hz	132,66

Válvula piloto SP/NC normalmente cerrada.

Juntas NBR. 3/2 vías.

Rosca H 1/4". Montaje directo.



M

Ref.	Tipo de válvula	€
SDNO14N024DC	DK-DKB-DKD-CM/CP Voltaje 24V DC	195,27

Válvula piloto SD/NO normalmente abierta.

Juntas NBR. 3/2 vías.

Rosca H 1/4". Montaje directo.



M

Ref.	Tipo de válvula	€
SMNO18N024DC	DK-DKB-DKD-CM/CP Voltaje 24V DC	196,70

Válvula piloto SM/NO normalmente abierta.

Juntas NBR. 3/2 vías.

Rosca H 1/8". Montaje en batería.



M

Ref.	Tipo de válvula	€
2EV024DC	DK-DKB/CP* Voltaje 24V	133,95
2EV024AC	DK-DKB/CP* Voltaje 24V AC 50 Hz	133,95
2EV110AC	DK-DKB/CP* Voltaje 110V AC 50 Hz	133,95
2EV220AC	DK-DKB/CP* Voltaje 220V AC 50 Hz	133,95

Válvula piloto NAMUR "2EV".
NAMUR 3-5/2 vías. Montaje directo.* Para montar con adaptador
ZAD2428001

M

DN	Ref.	Tipo de válvula	€
15+65	ZAD2428001	DK/CP	40,08
15+65	ZAD2428001	DKB/CP	40,08

Adaptador NAMUR para válvula piloto "2EV".
Conexión NAMUR.



INDUSTRIA

Válvulas motorizadas de PVC-U presión

Válvulas de control de presión



SVUIV



L

d - Rh	Ref.	DN	PN	€ EPDM	€ FKM
20 - 1/2"	SVUIV020E	15	16	148,22	152,14
25 - 3/4"	SVUIV025E	20	16	158,81	164,13
32 - 1"	SVUIV032E	25	16	170,68	176,00

Válvula de sobrepresión seguridad.

Con enlaces H-H

para encolar (rosacar bajo pedido).

Código en FKM termina en "F"
en lugar de "E"

Rango de calibración: 0,3 - 4 bars

VPR



L

d	Ref.	DN	PN	€ EPDM	€ FKM
16	VPRDV016E	10	10	752,73	779,44
20	VPRDV020E	15	10	752,73	779,44
25	VPRDV025E	20	10	958,19	1.000,74
32	VPRDV032E	25	10	958,19	1.000,74
40	VPRDV040E	32	10	1.153,37	1.204,80
50	VPRDV050E	40	10	1.153,37	1.204,80
63	VPRDV063E	50	10	1.632,25	1.682,99

Válvula reductora de presión.

M-M encolar.

Código en FKM termina en "F"
en lugar de "E"

Rango de calibración: 0,5 - 9 bars

VSF



L

d	Ref. EPDM	DN	PN	€ EPDM	€ PTFE
16	VSFDV016E	10	10	294,48	337,87
20	VSFDV020E	15	10	342,85	363,74
25	VSFDV025E	20	10	383,39	416,00
32	VSFDV032E	25	10	405,39	436,52
40	VSFDV040E	32	10	509,06	557,76
50	VSFDV050E	40	10	973,91	1.013,31
63	VSFDV063E	50	10	1.144,34	1.180,75
75	VSFDV075E	65	10	1.536,80	1.610,77
90	VSFDV090E	80	10	2.575,17	2.696,39
110	VSFDV110E	100	10	3.701,85	3.850,12

Válvula de sobrepresión-alivio.

M-M encolar.

Código en PTFE termina en "P"
en lugar de "E"

Rango de calibración: 0,5 - 10 bars

VCP



L

d	Ref. EPDM	DN	PN	€ EPDM	€ PTFE
16	VCPDV016E	10	10	267,44	286,22
20	VCPDV020E	15	10	270,39	297,95
25	VCPDV025E	20	10	360,48	391,61
32	VCPDV032E	25	10	384,85	426,23
40	VCPDV040E	32	10	491,71	528,14
50	VCPDV050E	40	10	930,06	964,21
63	VCPDV063E	50	10	995,52	1.016,01

Válvula retenedora de presión.

M-M encolar.

Código en PTFE termina en "P"
en lugar de "E"

Rango de calibración: 0,5 - 10 bars

Flujómetros /rotámetros

Medidores electrónicos de caudal

Electrodos de pH y ORP

Sensores y transmisores de conductividad

Accesorios y recambios

Medición

INDUSTRIA









INDUSTRIA

Medición

Flujómetros modelo corto



FCIV
encolar.

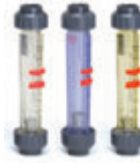

FLOTADOR INOX AISI 316

Encolar	Diámetro Roscar	Ref. Encolar	Escala l/h.	S €
16	3/8"	FC16D1X0030	3-30	110,64
16	3/8"	FC16D1X0040	4-40	110,64
16	3/8"	FC16D1X0100	10-100	110,64
16	3/8"	FC16D1X0200	20-200	110,64
16	3/8"	FC16D1X0300	30-300	110,64
20	1/2"	FC20D1X0050	5-50	116,27
20	1/2"	FC20D1X0100	10-100	116,27
20	1/2"	FC20D1X0160	15-160	116,27
20	1/2"	FC20D1X0250	20-250	116,27
20	1/2"	FC20D1X0350	35-350	116,27
20	1/2"	FC20D1X0600	60-600	116,27
25	3/4"	FC25D1X0150	15-150	121,87
25	3/4"	FC25D1X0250	25-250	121,87
25	3/4"	FC25D1X0400	40-400	121,87
25	3/4"	FC25D1X0600	50-600	121,87
25	3/4"	FC25D1X1100	100-1100	121,87
32	1"	FC32D1X0400	40-400	135,01
32	1"	FC32D1X0600	50-600	135,01
32	1"	FC32D1X1000	100-1000	135,01
32	1"	FC32D1X1500	150-1500	135,01

FLOTADOR PP ROJO

16	3/8"	FC16D1M0015	1,5-15	110,64
16	3/8"	FC16D1M0020	2-20	110,64
16	3/8"	FC16D1M0050	5-50	110,64
16	3/8"	FC16D1M0100	10-100	110,64
16	3/8"	FC16D1M0150	15-150	110,64
20	1/2"	FC20D1M0025	2-25	116,27
20	1/2"	FC20D1M0050	5-50	116,27
20	1/2"	FC20D1M0100	10-100	116,27
20	1/2"	FC20D1M0150	15-150	116,27
20	1/2"	FC20D1M0200	20-200	116,27
20	1/2"	FC20D1M0320	30-320	116,27
25	3/4"	FC25D1M0080	8-80	121,87
25	3/4"	FC25D1M0150	15-150	121,87
25	3/4"	FC25D1M0200	20-200	121,87
25	3/4"	FC25D1M0350	30-350	121,87
25	3/4"	FC25D1M0650	50-650	121,87
32	1"	FC32D1M0200	20-200	135,01
32	1"	FC32D1M0300	30-300	135,01
32	1"	FC32D1M0600	60-600	135,01
32	1"	FC32D1M1000	100-1000	135,01

Flujómetro corto para H₂O.

Densidad: 1 kg/l - 20° C. Cuerpo: TROGAMID. Juntas: EPDM.

FCIV
 encolar.

FLOTADOR INOX AISI 316 CON IMÁN INTERIOR incorporado para contacto exterior (suministrado aparte)

Encolar	Diámetro Roscar	Ref. Encolar	Escala l/h.	S €
16	3/8"	FC16D1X0030M	3-30	166,90
16	3/8"	FC16D1X0040M	4-40	166,90
16	3/8"	FC16D1X0100M	10-100	166,90
16	3/8"	FC16D1X0200M	20-200	166,90
16	3/8"	FC16D1X0300M	30-300	166,90
20	1/2"	FC20D1X0050M	5-50	170,65
20	1/2"	FC20D1X0100M	10-100	170,65
20	1/2"	FC20D1X0160M	15-160	170,65
20	1/2"	FC20D1X0250M	20-250	170,65
20	1/2"	FC20D1X0350M	35-350	170,65
20	1/2"	FC20D1X0600M	60-600	170,65
25	3/4"	FC25D1X0150M	15-150	178,16
25	3/4"	FC25D1X0250M	25-250	178,16
25	3/4"	FC25D1X0400M	40-400	178,16
25	3/4"	FC25D1X0600M	50-600	178,16
25	3/4"	FC25D1X1100M	100-1100	178,16
32	1"	FC32D1X0400M	40-400	200,65
32	1"	FC32D1X0600M	50-600	200,65
32	1"	FC32D1X1000M	100-1000	200,65
32	1"	FC32D1X1500M	150-1500	200,65

FLOTADOR PP ROJO CON IMÁN INTERIOR incorporado para contacto exterior (suministrado aparte)

16	3/8"	FC16D1M0015M	1,5-15	166,90
16	3/8"	FC16D1M0020M	2-20	166,90
16	3/8"	FC16D1M0050M	5-50	166,90
16	3/8"	FC16D1M0100M	10-100	166,90
16	3/8"	FC16D1M0150M	15-150	166,90
20	1/2"	FC20D1M0025M	2-25	170,65
20	1/2"	FC20D1M0050M	5-50	170,65
20	1/2"	FC20D1M0100M	10-100	170,65
20	1/2"	FC20D1M0150M	15-150	170,65
20	1/2"	FC20D1M0200M	20-200	170,65
20	1/2"	FC20D1M0320M	30-320	170,65
25	3/4"	FC25D1M0080M	8-80	178,16
25	3/4"	FC25D1M0150M	15-150	178,16
25	3/4"	FC25D1M0200M	20-200	178,16
25	3/4"	FC25D1M0350M	30-350	178,16
25	3/4"	FC25D1M0650M	50-650	178,16
32	1"	FC32D1M0200M	20-200	200,65
32	1"	FC32D1M0300M	30-300	200,65
32	1"	FC32D1M0600M	60-600	200,65
32	1"	FC32D1M1000M	100-1000	200,65

 Flujómetro corto para H₂O.

Densidad: 1 kg/l - 20° C. Cuerpo: TROGAMID. Juntas: EPDM.

FCIV
 encolar.

FLOTADOR INOX AISI 316

Encolar	Diámetro Roscar	Ref. Encolar	Escala l/h.	S €
16	3/8"	FC16T1X0030	3-30	106,88
16	3/8"	FC16T1X0040	4-40	106,88
16	3/8"	FC16T1X0100	10-100	106,88
16	3/8"	FC16T1X0200	20-200	106,88
16	3/8"	FC16T1X0300	30-300	106,88
20	1/2"	FC20T1X0050	5-50	112,52
20	1/2"	FC20T1X0100	10-100	112,52
20	1/2"	FC20T1X0160	15-160	112,52
20	1/2"	FC20T1X0250	20-250	112,52
20	1/2"	FC20T1X0350	35-350	112,52
20	1/2"	FC20T1X0600	60-600	112,52
25	3/4"	FC25T1X0150	15-150	118,16
25	3/4"	FC25T1X0250	25-250	118,16
25	3/4"	FC25T1X0400	40-400	118,16
25	3/4"	FC25T1X0600	50-600	118,16
25	3/4"	FC25T1X1100	100-1100	118,16
32	1"	FC32T1X0400	40-400	131,28
32	1"	FC32T1X0600	50-600	131,28
32	1"	FC32T1X1000	100-1000	131,28
32	1"	FC32T1X1500	150-1500	131,28

FLOTADOR PP ROJO

16	3/8"	FC16T1M0015	1,5-15	106,88
16	3/8"	FC16T1M0020	2-20	106,88
16	3/8"	FC16T1M0050	5-50	106,88
16	3/8"	FC16T1M0100	10-100	106,88
16	3/8"	FC16T1M0150	15-150	106,88
20	1/2"	FC20T1M0025	2-25	112,52
20	1/2"	FC20T1M0050	5-50	112,52
20	1/2"	FC20T1M0100	10-100	112,52
20	1/2"	FC20T1M0150	15-150	112,52
20	1/2"	FC20T1M0200	20-200	112,52
20	1/2"	FC20T1M0320	30-320	112,52
25	3/4"	FC25T1M0080	8-80	118,16
25	3/4"	FC25T1M0150	15-150	118,16
25	3/4"	FC25T1M0200	20-200	118,16
25	3/4"	FC25T1M0350	30-350	118,16
25	3/4"	FC25T1M0650	50-650	118,16
32	1"	FC32T1M0200	20-200	131,28
32	1"	FC32T1M0300	30-300	131,28
32	1"	FC32T1M0600	60-600	131,28
32	1"	FC32T1M1000	100-1000	131,28

 Flujómetro corto para H₂O.

Densidad: 1 kg/l - 20° C. Cuerpo: PVC Transparente. Juntas: EPDM.

FCIV
 encolar.

FLOTADOR INOX AISI 316 CON IMÁN INTERIOR incorporado para contacto exterior (suministrado aparte)

Encolar	Diámetro Roscar	Ref. Encolar	Escala l/h.	S €
16	3/8"	FC16T1X0030M	3-30	163,13
16	3/8"	FC16T1X0040M	4-40	163,13
16	3/8"	FC16T1X0100M	10-100	163,13
16	3/8"	FC16T1X0200M	20-200	163,13
16	3/8"	FC16T1X0300M	30-300	163,13
20	1/2"	FC20T1X0050M	5-50	166,90
20	1/2"	FC20T1X0100M	10-100	166,90
20	1/2"	FC20T1X0160M	15-160	166,90
20	1/2"	FC20T1X0250M	20-250	166,90
20	1/2"	FC20T1X0350M	35-350	166,90
20	1/2"	FC20T1X0600M	60-600	166,90
25	3/4"	FC25T1X0150M	15-150	174,40
25	3/4"	FC25T1X0250M	25-250	174,40
25	3/4"	FC25T1X0400M	40-400	174,40
25	3/4"	FC25T1X0600M	50-600	174,40
25	3/4"	FC25T1X1100M	100-1100	174,40
32	1"	FC32T1X0400M	40-400	196,89
32	1"	FC32T1X0600M	50-600	196,89
32	1"	FC32T1X1000M	100-1000	196,89
32	1"	FC32T1X1500M	150-1500	196,89

FLOTADOR PP ROJO CON IMÁN INTERIOR incorporado para contacto exterior (suministrado aparte)

16	3/8"	FC16T1M0015M	1,5-15	163,13
16	3/8"	FC16T1M0020M	2-20	163,13
16	3/8"	FC16T1M0050M	5-50	163,13
16	3/8"	FC16T1M0100M	10-100	163,13
16	3/8"	FC16T1M0150M	15-150	163,13
20	1/2"	FC20T1M0025M	2-25	166,90
20	1/2"	FC20T1M0050M	5-50	166,90
20	1/2"	FC20T1M0100M	10-100	166,90
20	1/2"	FC20T1M0150M	15-150	166,90
20	1/2"	FC20T1M0200M	20-200	166,90
20	1/2"	FC20T1M0320M	30-320	166,90
25	3/4"	FC25T1M0080M	8-80	174,40
25	3/4"	FC25T1M0150M	15-150	174,40
25	3/4"	FC25T1M0200M	20-200	174,40
25	3/4"	FC25T1M0350M	30-350	174,40
25	3/4"	FC25T1M0650M	50-650	174,40
32	1"	FC32T1M0200M	20-200	196,89
32	1"	FC32T1M0300M	30-300	196,89
32	1"	FC32T1M0600M	60-600	196,89
32	1"	FC32T1M1000M	100-1000	196,89

Flujómetro corto para H₂O.

Densidad: 1 kg/l - 20° C. Cuerpo: PVC Transparente. Juntas: EPDM.

FCIV
 encolar.



FLOTADOR INOX AISI 316

Encolar	Diámetro Roscar	Ref. Encolar	Escala l/h.	S €
16	3/8"	FC16P1X0030	3-30	121,87
16	3/8"	FC16P1X0040	4-40	121,87
16	3/8"	FC16P1X0100	10-100	121,87
16	3/8"	FC16P1X0200	20-200	121,87
16	3/8"	FC16P1X0300	30-300	121,87
20	1/2"	FC20P1X0050	5-50	129,41
20	1/2"	FC20P1X0100	10-100	129,41
20	1/2"	FC20P1X0160	15-160	129,41
20	1/2"	FC20P1X0250	20-250	129,41
20	1/2"	FC20P1X0350	35-350	129,41
20	1/2"	FC20P1X0600	60-600	129,41
25	3/4"	FC25P1X0150	15-150	138,77
25	3/4"	FC25P1X0250	25-250	138,77
25	3/4"	FC25P1X0400	40-400	138,77
25	3/4"	FC25P1X0600	50-600	138,77
25	3/4"	FC25P1X1100	100-1100	138,77
32	1"	FC32P1X0400	40-400	155,67
32	1"	FC32P1X0600	50-600	155,67
32	1"	FC32P1X1000	100-1000	155,67
32	1"	FC32P1X1500	150-1500	155,67

FLOTADOR PP ROJO

16	3/8"	FC16P1M0015	1,5-15	121,87
16	3/8"	FC16P1M0020	2-20	121,87
16	3/8"	FC16P1M0050	5-50	121,87
16	3/8"	FC16P1M0100	10-100	121,87
16	3/8"	FC16P1M0150	15-150	121,87
20	1/2"	FC20P1M0025	2-25	129,41
20	1/2"	FC20P1M0050	5-50	129,41
20	1/2"	FC20P1M0100	10-100	129,41
20	1/2"	FC20P1M0150	15-150	129,41
20	1/2"	FC20P1M0200	20-200	129,41
20	1/2"	FC20P1M0320	30-320	129,41
25	3/4"	FC25P1M0080	8-80	138,77
25	3/4"	FC25P1M0150	15-150	138,77
25	3/4"	FC25P1M0200	20-200	138,77
25	3/4"	FC25P1M0350	30-350	138,77
25	3/4"	FC25P1M0650	50-650	138,77
32	1"	FC32P1M0200	20-200	155,67
32	1"	FC32P1M0300	30-300	155,67
32	1"	FC32P1M0600	60-600	155,67
32	1"	FC32P1M1000	100-1000	155,67

Flujómetro corto para **H₂O**.

Densidad: 1 kg/l - 20° C. Cuerpo: **POLYSULFON** Juntas: **EPDM**.

FCIV
 encolar.

FLOTADOR INOX AISI 316 CON IMÁN INTERIOR incorporado para contacto exterior (suministrado aparte)

Encolar	Diámetro Roscar	Ref. Encolar	Escala l/h.	S €
16	3/8"	FC16P1X0030M	3-30	180,03
16	3/8"	FC16P1X0040M	4-40	180,03
16	3/8"	FC16P1X0100M	10-100	180,03
16	3/8"	FC16P1X0200M	20-200	180,03
16	3/8"	FC16P1X0300M	30-300	180,03
20	1/2"	FC20P1X0050M	5-50	185,65
20	1/2"	FC20P1X0100M	10-100	185,65
20	1/2"	FC20P1X0160M	15-160	185,65
20	1/2"	FC20P1X0250M	20-250	185,65
20	1/2"	FC20P1X0350M	35-350	185,65
20	1/2"	FC20P1X0600M	60-600	185,65
25	3/4"	FC25P1X0150M	15-150	195,03
25	3/4"	FC25P1X0250M	25-250	195,03
25	3/4"	FC25P1X0400M	40-400	195,03
25	3/4"	FC25P1X0600M	50-600	195,03
25	3/4"	FC25P1X1100M	100-1100	195,03
32	1"	FC32P1X0400M	40-400	221,28
32	1"	FC32P1X0600M	50-600	221,28
32	1"	FC32P1X1000M	100-1000	221,28
32	1"	FC32P1X1500M	150-1500	221,28

FLOTADOR PP ROJO CON IMÁN INTERIOR incorporado para contacto exterior (suministrado aparte)

16	3/8"	FC16P1M0015M	1,5-15	180,03
16	3/8"	FC16P1M0020M	2-20	180,03
16	3/8"	FC16P1M0050M	5-50	180,03
16	3/8"	FC16P1M0100M	10-100	180,03
16	3/8"	FC16P1M0150M	15-150	180,03
20	1/2"	FC20P1M0025M	2-25	185,65
20	1/2"	FC20P1M0050M	5-50	185,65
20	1/2"	FC20P1M0100M	10-100	185,65
20	1/2"	FC20P1M0150M	15-150	185,65
20	1/2"	FC20P1M0200M	20-200	185,65
20	1/2"	FC20P1M0320M	30-320	185,65
25	3/4"	FC25P1M0080M	8-80	195,03
25	3/4"	FC25P1M0150M	15-150	195,03
25	3/4"	FC25P1M0200M	20-200	195,03
25	3/4"	FC25P1M0350M	30-350	195,03
25	3/4"	FC25P1M0650M	50-650	195,03
32	1"	FC32P1M0200M	20-200	221,28
32	1"	FC32P1M0300M	30-300	221,28
32	1"	FC32P1M0600M	60-600	221,28
32	1"	FC32P1M1000M	100-1000	221,28

Flujómetro corto para H₂O.

Densidad: 1 kg/l - 20° C. Cuerpo: POLYSULFON. Juntas: EPDM.

FCIV
 encolar.

FLOTADOR INOX AISI 316

Encolar	Diámetro Roscar	Ref. Encolar	Escala l/h.	S €
16	3/8"	FC16T3X0085	0,5-8,5	106,88
16	3/8"	FC16T3X0040	2,5-40	106,88
16	3/8"	FC16T3X0120	10-120	106,88
16	3/8"	FC16T3X0180	15-180	106,88
20	1/2"	FC20T3X0375	2,5-37,5	112,52
20	1/2"	FC20T3X0075	4-75	112,52
20	1/2"	FC20T3X0140	5-140	112,52
20	1/2"	FC20T3X0220	9-220	112,52
20	3/4"	FC20T3X0360	24-360	112,52
25	3/4"	FC25T3X0135	6-135	118,16
25	3/4"	FC25T3X0230	13-230	118,16
25	3/4"	FC25T3X0350	20-350	118,16
25	3/4"	FC25T3X0650	25-650	118,16
32	1"	FC32T3X0220	10-220	131,28
32	1"	FC32T3X0350	20-350	131,28
32	1"	FC32T3X0650	25-650	131,28
32	1"	FC32T3X1000	50-1000	131,28

FLOTADOR PP ROJO

16	3/8"	FC16T3M0003	0,25-3	106,88
16	3/8"	FC16T3M0017	1-17	106,88
16	3/8"	FC16T3M0045	2,5-45	106,88
16	3/8"	FC16T3M0075	5-75	106,88
20	1/2"	FC20T3M0125	1-12,5	112,52
20	1/2"	FC20T3M0034	2-34	112,52
20	1/2"	FC20T3M0063	2,5-63	112,52
20	1/2"	FC20T3M0104	5-104	112,52
20	3/4"	FC20T3M0170	10-170	112,52
25	3/4"	FC25T3M0060	3,5-60	118,16
25	3/4"	FC25T3M0092	5-92	118,16
25	3/4"	FC25T3M0165	8-165	118,16
25	3/4"	FC25T3M0380	20-380	118,16
32	1"	FC32T3M0090	5-90	131,28
32	1"	FC32T3M0150	7,5-150	131,28
32	1"	FC32T3M0360	20-360	131,28
32	1"	FC32T3M0650	25-650	131,28

 Flujómetro corto para **Hidróxido de sodio (NaOH) 30%..**

 Densidad: 1,33 kg/l - 20° C. Cuerpo **PVC Transparente**. Juntas: **EPDM**.

FCIV
 encolar.

FLOTADOR INOX AISI 316 CON IMÁN INTERIOR incorporado para contacto exterior (suministrado aparte)

Encolar	Diámetro Roscar	Ref. Encolar	Escala l/h.	S €
16	3/8"	FC16T3X0085M	0,5-8,5	163,13
16	3/8"	FC16T3X0040M	2,5-40	163,13
16	3/8"	FC16T3X0120M	10-120	163,13
16	3/8"	FC16T3X0180M	15-180	163,13
20	1/2"	FC20T3X0375M	2,5-37,5	166,90
20	1/2"	FC20T3X0075M	4-75	166,90
20	1/2"	FC20T3X0140M	5-140	166,90
20	1/2"	FC20T3X0220M	9-220	166,90
20	3/4"	FC20T3X0360M	24-360	166,90
25	3/4"	FC25T3X0135M	6-135	174,40
25	3/4"	FC25T3X0230M	13-230	174,40
25	3/4"	FC25T3X0350M	20-350	174,40
25	3/4"	FC25T3X0650M	25-650	174,40
32	1"	FC32T3X0220M	10-220	196,89
32	1"	FC32T3X0350M	20-350	196,89
32	1"	FC32T3X0650M	25-650	196,89
32	1"	FC32T3X1000M	50-1000	196,89

FLOTADOR PP ROJO CON IMÁN INTERIOR incorporado para contacto exterior (suministrado aparte)

16	3/8"	FC16T3M0003M	0,25-3	163,13
16	3/8"	FC16T3M0017M	1-17	163,13
16	3/8"	FC16T3M0045M	2,5-45	163,13
16	3/8"	FC16T3M0075M	5-75	163,13
20	1/2"	FC20T3M0125M	1-12,5	166,90
20	1/2"	FC20T3M0034M	2-34	166,90
20	1/2"	FC20T3M0063M	2,5-63	166,90
20	1/2"	FC20T3M0104M	5-104	166,90
20	3/4"	FC20T3M0170M	10-170	166,90
25	3/4"	FC25T3M0060M	3,5-60	174,40
25	3/4"	FC25T3M0092M	5-92	174,40
25	3/4"	FC25T3M0165M	8-165	174,40
25	3/4"	FC25T3M0380M	20-380	174,40
32	1"	FC32T3M0090M	5-90	196,89
32	1"	FC32T3M0150M	7,5-150	196,89
32	1"	FC32T3M0360M	20-360	196,89
32	1"	FC32T3M0650M	25-650	196,89

 Flujómetro corto para **Hidróxido de sodio (NaOH) 30%..**

 Densidad: 1,33 kg/l - 20° C. Cuerpo **PVC Transparente**. Juntas: **EPDM**.

FCIV
 encolar.

FLOTADOR INOX AISI 316

Encolar	Diámetro Roscar	Ref. Encolar	Escala l/h.	S €
16	3/8"	FC16P3X0085	0,5-8,5	121,87
16	3/8"	FC16P3X0040	2,5-40	121,87
16	3/8"	FC16P3X0120	10-120	121,87
16	3/8"	FC16P3X0180	15-180	121,87
20	1/2"	FC20P3X0375	2,5-37,5	129,41
20	1/2"	FC20P3X0075	4-75	129,41
20	1/2"	FC20P3X0140	5-140	129,41
20	1/2"	FC20P3X0220	9-220	129,41
20	3/4"	FC20P3X0360	24-360	129,41
25	3/4"	FC25P3X0135	6-135	138,77
25	3/4"	FC25P3X0230	13-230	138,77
25	3/4"	FC25P3X0350	20-350	138,77
25	3/4"	FC25P3X0650	25-650	138,77
32	1"	FC32P3X0220	10-220	155,67
32	1"	FC32P3X0350	20-350	155,67
32	1"	FC32P3X0650	25-650	155,67
32	1"	FC32P3X1000	50-1000	155,67

FLOTADOR PP ROJO

16	3/8"	FC16P3M0003	0,25-3	121,87
16	3/8"	FC16P3M0017	1-17	121,87
16	3/8"	FC16P3M0045	2,5-45	121,87
16	3/8"	FC16P3M0075	5-75	121,87
20	1/2"	FC20P3M0125	1-12,5	129,41
20	1/2"	FC20P3M0034	2-34	129,41
20	1/2"	FC20P3M0063	2,5-63	129,41
20	1/2"	FC20P3M0104	5-104	129,41
20	3/4"	FC20P3M0170	10-170	129,41
25	3/4"	FC25P3M0060	3,5-60	138,77
25	3/4"	FC25P3M0092	5-92	138,77
25	3/4"	FC25P3M0165	8-165	138,77
25	3/4"	FC25P3M0380	20-380	138,77
32	1"	FC32P3M0090	5-90	155,67
32	1"	FC32P3M0150	7,5-150	155,67
32	1"	FC32P3M0360	20-360	155,67
32	1"	FC32P3M0650	25-650	155,67

 Flujómetro corto para **Hidróxido de sodio (NaOH) 30%..**

 Densidad: 1,33 kg/l - 20° C. Cuerpo **POLYSULFON..** Juntas: **EPDM.**

FCIV
 encolar.

FLOTADOR INOX AISI 316 CON IMÁN INTERIOR incorporado para contacto exterior (suministrado aparte)

Encolar	Diámetro Roscar	Ref. Encolar	Escala l/h.	S €
16	3/8"	FC16P3X0085M	0,5-8,5	180,03
16	3/8"	FC16P3X0040M	2,5-40	180,03
16	3/8"	FC16P3X0120M	10-120	180,03
16	3/8"	FC16P3X0180M	15-180	180,03
20	1/2"	FC20P3X0375M	2,5-37,5	185,65
20	1/2"	FC20P3X0075M	4-75	185,65
20	1/2"	FC20P3X0140M	5-140	185,65
20	1/2"	FC20P3X0220M	9-220	185,65
20	3/4"	FC20P3X0360M	24-360	185,65
25	3/4"	FC25P3X0135M	6-135	195,03
25	3/4"	FC25P3X0230M	13-230	195,03
25	3/4"	FC25P3X0350M	20-350	195,03
25	3/4"	FC25P3X0650M	25-650	195,03
32	1"	FC32P3X0220M	10-220	221,28
32	1"	FC32P3X0350M	20-350	221,28
32	1"	FC32P3X0650M	25-650	221,28
32	1"	FC32P3X1000M	50-1000	221,28

FLOTADOR PP ROJO CON IMÁN INTERIOR incorporado para contacto exterior (suministrado aparte)

16	3/8"	FC16P3M0003M	0,25-3	180,03
16	3/8"	FC16P3M0017M	1-17	180,03
16	3/8"	FC16P3M0045M	2,5-45	180,03
16	3/8"	FC16P3M0075M	5-75	180,03
20	1/2"	FC20P3M0125M	1-12,5	185,65
20	1/2"	FC20P3M0034M	2-34	185,65
20	1/2"	FC20P3M0063M	2,5-63	185,65
20	1/2"	FC20P3M0104M	5-104	185,65
20	3/4"	FC20P3M0170M	10-170	185,65
25	3/4"	FC25P3M0060M	3,5-60	195,03
25	3/4"	FC25P3M0092M	5-92	195,03
25	3/4"	FC25P3M0165M	8-165	195,03
25	3/4"	FC25P3M0380M	20-380	195,03
32	1"	FC32P3M0090M	5-90	221,28
32	1"	FC32P3M0150M	7,5-150	221,28
32	1"	FC32P3M0360M	20-360	221,28
32	1"	FC32P3M0650M	25-650	221,28

 Flujómetro corto para **Hidróxido de sodio (NaOH) 30%..**

 Densidad: 1,33 kg/l - 20° C. Cuerpo **POLYSULFON**. Juntas: **EPDM**.

FCIV
 encolar.



FLOTADOR INOX AISI 316

Encolar	Diámetro Roscar	Ref. Encolar	Escala l/h.	S €
16	3/8"	FC16T5X0014	0,05-1,4	106,88
16	3/8"	FC16T5X0008	0,5-8	106,88
16	3/8"	FC16T5X0040	2,5-40	106,88
16	3/8"	FC16T5X0055	4-55	106,88
20	1/2"	FC20T5X0065	0,25-6,5	112,52
20	1/2"	FC20T5X0015	1-15	112,52
20	1/2"	FC20T5X0036	2-36	112,52
20	1/2"	FC20T5X0075	4-75	112,52
20	3/4"	FC20T5X0140	6-140	112,52
25	3/4"	FC25T5X0030	2,5-30	118,16
25	3/4"	FC25T5X0065	3-65	118,16
25	3/4"	FC25T5X0135	4-135	118,16
25	3/4"	FC25T5X0320	20-320	118,16
32	1"	FC32T5X0055	2,5-55	131,28
32	1"	FC32T5X0125	5-125	131,28
32	1"	FC32T5X0300	20-300	131,28
32	1"	FC32T5X0600	25-600	131,28

FLOTADOR PP ROJO

16	3/8"	FC16T5M0005	0,025-0,5	106,88
16	3/8"	FC16T5M0275	0,25-2,75	106,88
16	3/8"	FC16T5M0009	0,5-9	106,88
16	3/8"	FC16T5M0021	1-21	106,88
20	1/2"	FC20T5M0002	0,1-2	112,52
20	1/2"	FC20T5M0055	0,25-5,5	112,52
20	1/2"	FC20T5M0125	0,5-12,5	112,52
20	1/2"	FC20T5M0255	2-25,5	112,52
20	3/4"	FC20T5M0475	2,5-47,5	112,52
25	3/4"	FC25T5M0010	1-10	118,16
25	3/4"	FC25T5M0019	1-19	118,16
25	3/4"	FC25T5M0045	2-45	118,16
25	3/4"	FC25T5M0130	4-130	118,16
32	1"	FC32T5M0015	1-15	131,28
32	1"	FC32T5M0040	2-40	131,28
32	1"	FC32T5M0110	5-110	131,28
32	1"	FC32T5M0260	10-260	131,28

Flujómetro corto para **Hidróxido de sodio (NaOH) 50%..**
 Densidad: 1,53 kg/l - 20° C. Cuerpo **PVC Transparente**. Juntas: **EPDM**.

FCIV
 encolar.

FLOTADOR INOX AISI 316 CON IMÁN INTERIOR incorporado para contacto exterior (suministrado aparte)

Encolar	Diámetro Roscar	Ref. Encolar	Escala l/h.	S €
16	3/8"	FC16T5X0014M	0,05-1,4	163,13
16	3/8"	FC16T5X0008M	0,5-8	163,13
16	3/8"	FC16T5X0040M	2,5-40	163,13
16	3/8"	FC16T5X0055M	4-55	163,13
20	1/2"	FC20T5X0065M	0,25-6,5	166,90
20	1/2"	FC20T5X0015M	1-15	166,90
20	1/2"	FC20T5X0036M	2-36	166,90
20	1/2"	FC20T5X0075M	4-75	166,90
20	3/4"	FC20T5X0140M	6-140	166,90
25	3/4"	FC25T5X0030M	2,5-30	174,40
25	3/4"	FC25T5X0065M	3-65	174,40
25	3/4"	FC25T5X0135M	4-135	174,40
25	3/4"	FC25T5X0320M	20-320	174,40
32	1"	FC32T5X0055M	2,5-55	196,89
32	1"	FC32T5X0125M	5-125	196,89
32	1"	FC32T5X0300M	20-300	196,89
32	1"	FC32T5X0600M	25-600	196,89

FLOTADOR PP ROJO CON IMÁN INTERIOR incorporado para contacto exterior (suministrado aparte)

16	3/8"	FC16T5M0005M	0,025-0,5	163,13
16	3/8"	FC16T5M0275M	0,25-2,75	163,13
16	3/8"	FC16T5M0009M	0,5-9	163,13
16	3/8"	FC16T5M0021M	1-21	163,13
20	1/2"	FC20T5M0002M	0,1-2	166,90
20	1/2"	FC20T5M0055M	0,25-5,5	166,90
20	1/2"	FC20T5M0125M	0,5-12,5	166,90
20	1/2"	FC20T5M0255M	2-25,5	166,90
20	3/4"	FC20T5M0475M	2,5-47,5	166,90
25	3/4"	FC25T5M0010M	1-10	174,40
25	3/4"	FC25T5M0019M	1-19	174,40
25	3/4"	FC25T5M0045M	2-45	174,40
25	3/4"	FC25T5M0130M	4-130	174,40
32	1"	FC32T5M0015M	1-15	196,89
32	1"	FC32T5M0040M	2-40	196,89
32	1"	FC32T5M0110M	5-110	196,89
32	1"	FC32T5M0260M	10-260	196,89

 Flujómetro corto para **Hidróxido de sodio (NaOH) 50%..**

 Densidad: 1,53 kg/l - 20° C. Cuerpo **PVC Transparente**. Juntas: **EPDM**.

FCIV
 encolar.

FLOTADOR INOX AISI 316

Encolar	Diámetro Roscar	Ref. Encolar	Escala l/h.	S €
16	3/8"	FC16P5X0014	0,05-1,4	121,87
16	3/8"	FC16P5X0008	0,5-8	121,87
16	3/8"	FC16P5X0040	2,5-40	121,87
16	3/8"	FC16P5X0055	4-55	121,87
20	1/2"	FC20P5X0065	0,25-6,5	129,41
20	1/2"	FC20P5X0015	1-15	129,41
20	1/2"	FC20P5X0036	2-36	129,41
20	1/2"	FC20P5X0075	4-75	129,41
20	3/4"	FC20P5X0140	6-140	129,41
25	3/4"	FC25P5X0030	2,5-30	138,77
25	3/4"	FC25P5X0065	3-65	138,77
25	3/4"	FC25P5X0135	4-135	138,77
25	3/4"	FC25P5X0320	20-320	138,77
32	1"	FC32P5X0055	2,5-55	155,67
32	1"	FC32P5X0125	5-125	155,67
32	1"	FC32P5X0300	20-300	155,67
32	1"	FC32P5X0600	25-600	155,67

FLOTADOR PP ROJO

16	3/8"	FC16P5M0005	0,025-0,5	121,87
16	3/8"	FC16P5M0275	0,25-2,75	121,87
16	3/8"	FC16P5M0009	0,5-9	121,87
16	3/8"	FC16P5M0021	1-21	121,87
20	1/2"	FC20P5M0002	0,1-2	129,41
20	1/2"	FC20P5M0055	0,25-5,5	129,41
20	1/2"	FC20P5M0125	0,5-12,5	129,41
20	1/2"	FC20P5M0255	2-25,5	129,41
20	3/4"	FC20P5M0475	2,5-47,5	129,41
25	3/4"	FC25P5M0010	1-10	138,77
25	3/4"	FC25P5M0019	1-19	138,77
25	3/4"	FC25P5M0045	2-45	138,77
25	3/4"	FC25P5M0130	4-130	138,77
32	1"	FC32P5M0015	1-15	155,67
32	1"	FC32P5M0040	2-40	155,67
32	1"	FC32P5M0110	5-110	155,67
32	1"	FC32P5M0260	10-260	155,67

 Flujómetro corto para **Hidróxido de sodio (NaOH) 50%..**

 Densidad: 1,53 kg/l - 20° C. Cuerpo **POLYSULFON..** Juntas: **EPDM.**

FCIV
 encolar.

FLOTADOR INOX AISI 316 CON IMÁN INTERIOR incorporado para contacto exterior (suministrado aparte)

Encolar	Diámetro Roscar	Ref. Encolar	Escala l/h.	S €
16	3/8"	FC16P5X0014M	0,05-1,4	180,03
16	3/8"	FC16P5X0008M	0,5-8	180,03
16	3/8"	FC16P5X0040M	2,5-40	180,03
16	3/8"	FC16P5X0055M	4-55	180,03
20	1/2"	FC20P5X0065M	0,25-6,5	185,65
20	1/2"	FC20P5X0015M	1-15	185,65
20	1/2"	FC20P5X0036M	2-36	185,65
20	1/2"	FC20P5X0075M	4-75	185,65
20	3/4"	FC20P5X0140M	6-140	185,65
25	3/4"	FC25P5X0030M	2,5-30	195,03
25	3/4"	FC25P5X0065M	3-65	195,03
25	3/4"	FC25P5X0135M	4-135	195,03
25	3/4"	FC25P5X0320M	20-320	195,03
32	1"	FC32P5X0055M	2,5-55	221,28
32	1"	FC32P5X0125M	5-125	221,28
32	1"	FC32P5X0300M	20-300	221,28
32	1"	FC32P5X0600M	25-600	221,28

FLOTADOR PP ROJO CON IMÁN INTERIOR incorporado para contacto exterior (suministrado aparte)

16	3/8"	FC16P5M0005M	0,025-0,5	180,03
16	3/8"	FC16P5M0275M	0,25-2,75	180,03
16	3/8"	FC16P5M0009M	0,5-9	180,03
16	3/8"	FC16P5M0021M	1-21	180,03
20	1/2"	FC20P5M0002M	0,1-2	185,65
20	1/2"	FC20P5M0055M	0,25-5,5	185,65
20	1/2"	FC20P5M0125M	0,5-12,5	185,65
20	1/2"	FC20P5M0255M	2-25,5	185,65
20	3/4"	FC20P5M0475M	2,5-47,5	185,65
25	3/4"	FC25P5M0010M	1-10	195,03
25	3/4"	FC25P5M0019M	1-19	195,03
25	3/4"	FC25P5M0045M	2-45	195,03
25	3/4"	FC25P5M0130M	4-130	195,03
32	1"	FC32P5M0015M	1-15	221,28
32	1"	FC32P5M0040M	2-40	221,28
32	1"	FC32P5M0110M	5-110	221,28
32	1"	FC32P5M0260M	10-260	221,28

 Flujómetro corto para **Hidróxido de sodio (NaOH) 50%..**

 Densidad: 1,53 kg/l - 20° C. Cuerpo **POLYSULFON**. Juntas: **EPDM**.

FCIV
 encolar.

FLOTADOR PP ROJO

Encolar	Diámetro Roscar	Ref. Encolar	Escala l/h.	S €
16	3/8"	FC16T2M0014	1,4-14	110,64
16	3/8"	FC16T2M0018	2-18	110,64
16	3/8"	FC16T2M0045	5-45	110,64
16	3/8"	FC16T2M0090	10-90	110,64
16	3/8"	FC16T2M0140	14-140	110,65
20	1/2"	FC20T2M0023	2-23	116,27
20	1/2"	FC20T2M0045	5-45	116,27
20	1/2"	FC20T2M0090	10-90	116,27
20	1/2"	FC20T2M0140	14-140	116,27
20	1/2"	FC20T2M0185	19-185	116,27
20	1/2"	FC20T2M0300	30-300	116,27
25	3/4"	FC25T2M0075	7,5-75	121,87
25	3/4"	FC25T2M0140	14-140	121,87
25	3/4"	FC25T2M0185	19-185	121,87
25	3/4"	FC25T2M0325	30-325	121,87
25	3/4"	FC25T2M0600	45-600	121,87
32	1"	FC32T2M0185	19-185	142,53
32	1"	FC32T2M0280	28-280	142,53
32	1"	FC32T2M0550	55-500	142,53
32	1"	FC32T2M0900	90-900	142,53

FLOTADOR PP ROJO CON IMÁN INTERIOR incorporado para contacto exterior (suministrado aparte)

16	3/8"	FC16T2M0014M	1,4-14	166,90
16	3/8"	FC16T2M0018M	2-18	166,90
16	3/8"	FC16T2M0045M	5-45	166,90
16	3/8"	FC16T2M0090M	10-90	166,90
16	3/8"	FC16T2M0140M	14-140	166,90
20	1/2"	FC20T2M0023M	2-23	170,65
20	1/2"	FC20T2M0045M	5-45	170,65
20	1/2"	FC20T2M0090M	10-90	170,65
20	1/2"	FC20T2M0140M	14-140	170,65
20	1/2"	FC20T2M0185M	19-185	170,65
20	1/2"	FC20T2M0300M	30-300	170,65
25	3/4"	FC25T2M0075M	7,5-75	178,16
25	3/4"	FC25T2M0140M	14-140	178,16
25	3/4"	FC25T2M0185M	19-185	178,16
25	3/4"	FC25T2M0325M	30-325	178,16
25	3/4"	FC25T2M0600M	45-600	178,16
32	1"	FC32T2M0185M	19-185	208,15
32	1"	FC32T2M0280M	28-280	208,15
32	1"	FC32T2M0550M	55-500	208,15
32	1"	FC32T2M0900M	90-900	208,15

 Flujómetro corto para **Ácido clorhídrico (HCl) 30-33%**.

 Densidad: 1,16 kg/l - 20° C. Cuerpo: **PVC Transparente**. Juntas: **EPDM**.

FCIV
 encolar.



FLOTADOR PP ROJO

Encolar	Diámetro Roscar	Ref. Encolar	Escala Nm³/h	S €
16	3/8"	FC16D0M0025	0,025-0,25	120,05
16	3/8"	FC16D0M0004	0,04-0,4	120,05
16	3/8"	FC16D0M0001	0,1-1	120,05
16	3/8"	FC16D0M0002	0,2-2	120,05
20	1/2"	FC20D0M0045	0,045-0,45	123,77
20	1/2"	FC20D0M0009	0,09-0,9	123,77
20	1/2"	FC20D0M0015	0,15-1,5	123,77
20	1/2"	FC20D0M0025	0,25-2,5	123,77
20	1/2"	FC20D0M0038	0,38-3,8	123,77
20	1/2"	FC20D0M0048	0,4-4,8	123,77
25	3/4"	FC25D0M0012	0,12-1,2	131,28
25	3/4"	FC25D0M0025	0,3-2,5	131,28
25	3/4"	FC25D0M0045	0,45-4,5	131,28
25	3/4"	FC25D0M0065	0,6-6,5	131,28
25	3/4"	FC25D0M0011	1,1-11	131,28
32	1"	FC32D0M0004	0,6-4	144,38
32	1"	FC32D0M0007	0,7-7	144,38
32	1"	FC32D0M0011	1,1-11	144,38
32	1"	FC32D0M0014	2-14	144,38

Flujómetro corto para **Aire**.

Densidad: 1,013 bar abs.- 20° Cuerpo: **TROGAMID**. Juntas: **EPDM**.



Ref.	Descripción	S1 €
MSMIN02	Contacto de MÍNIMA para diámetros 16-20-25 *	127,54
MSMAX02	Contacto de MAXIMA para diámetros 16-20-25 *	127,54
MSMIN01	Contacto de MÍNIMA para diámetros 32 *	127,54
MSMAX01	Contacto de MAXIMA para diámetros 32 *	127,54
	Escala especial	Consultar
	Doble escala	Consultar

Contactos exteriores.

Sólo utilizables con flujómetros que incorporen imán exterior.

* Para usar con flotador con imán incorporado.



d	Ref.	Descripción	I €
16	QBIC016	Manguito C-PVC	9,01
20	QBIC020	Manguito C-PVC	8,95
25	QBIC025	Manguito C-PVC	10,47
32	QBIC032	Manguito C-PVC	13,61
20	QBIGM020	Manguito PP-H	3,81
25	QBIGM025	Manguito PP-H	3,87
32	QBIGM032	Manguito PP-H	4,13
20	QBIGF020	Manguito PVDF	14,80
25	QBIGF025	Manguito PVDF	19,15
32	QBIGF032	Manguito PVDF	21,33

Manguitos.

Para cada flujómetro es necesario pedir 2 manguitos.

16	EFC034	Tuerca C-PVC	7,18
20	EFC100	Tuerca C-PVC	8,01
25	EFC114	Tuerca C-PVC	9,27
32	EFC112	Tuerca C-PVC	13,44
20	EFGM100	Tuerca PP-H	7,28
25	EFGM114	Tuerca PP-H	7,54
32	EFGM112	Tuerca PP-H	8,75
20	EFGF100	Tuerca PVDF	24,39
25	EFGF114	Tuerca PVDF	33,29
32	EFGF112	Tuerca PVDF	41,28

Tuercas.

Para cada flujómetro es necesario pedir 2 tuercas.

16	OR3062F	Junta FKM	4,35
20	OR4081F	Junta FKM	13,34
25	OR4112F	Junta FKM	2,51
32	OR4131F	Junta FKM	7,10

Juntas.

Para cada flujómetro es necesario pedir 2 juntas.

Bajo pedido disponemos también de conexiones rosca hembra de 3/8" a 1" en acero inoxidable AISI 316 y en acero al carbono.



INDUSTRIA

Medición

Flujómetros modelo largo



FSIV
encolar.



FLOTADOR INOX AISI 316

Encolar	Diámetro	Roscar	Ref. Encolar	Escala l/h.	S1 €
25		3/4"	FS25D1X0250	25-250	161,27
25		3/4"	FS25D1X0400	40-400	161,27
25		3/4"	FS25D1X0640	60-640	161,27
25		3/4"	FS25D1X1000	100-1000	161,27
32		3/8"	FS32D1X0400	40-400	183,79
32		1"	FS32D1X0640	60-640	183,79
32		1"	FS32D1X1000	100-1000	183,79
32		1"	FS32D1X1600	150-1600	183,79
40		1"	FS40D1X1600	150-1600	247,55
40		1 1/4"	FS40D1X2500	200-2500	247,55
40		1 1/4"	FS40D1X4000	400-4000	247,55
50		1 1/4"	FS50D1X2500	200-2500	292,53
50		1 1/2"	FS50D1X4000	400-4000	292,53
50		1 1/2"	FS50D1X5000	500-5000	292,53
63		2"	FS63D1X4000	400-4000	391,94
63		2"	FS63D1X6000	600-6000	391,94
63		2"	FS63D1X0010	1000-10000	391,94
75			FS75D1X0015	1500-15000	680,76
75			FS75D1X0020	2000-20000	680,76
75			FS75D1X0050	10000-50000	680,76

FLOTADOR PP ROJO

25		3/4"	FS25D1M0150	15-150	161,27
25		3/4"	FS25D1M0250	25-250	161,27
25		3/4"	FS25D1M0450	45-450	161,27
25		3/4"	FS25D1M0700	70-700	161,27
32		3/8"	FS32D1M0250	25-250	183,79
32		1"	FS32D1M0400	40-400	183,79
32		1"	FS32D1M0650	65-650	183,79
32		1"	FS32D1M1000	100-1000	183,79
40		1"	FS40D1M1000	100-1000	247,55
40		1 1/4"	FS40D1M1600	160-1600	247,55
40		1 1/4"	FS40D1M2500	200-2500	247,55
50		1 1/4"	FS50D1M1600	150-1600	292,53
50		1 1/2"	FS50D1M2200	200-2200	292,53
50		1 1/2"	FS50D1M2500	250-2500	292,53
63		2"	FS63D1M2500	250-2500	391,94
63		2"	FS63D1M3500	350-3500	391,94
63		2"	FS63D1M5000	500-5000	391,94
75			FS75D1M8000	1000-8000	680,76
75			FS75D1M0010	1000-10000	680,76
75			FS75D1M0025	5000-25000	680,76

Flujómetro largo para H₂O.

Densidad: 1 kg/l - 20° C. Cuerpo: TROGAMID. Juntas: EPDM.

FSIV
 encolar.

FLOTADOR INOX AISI 316 CON IMÁN INTERIOR incorporado para contacto exterior (suministrado aparte)

Encolar	Diámetro	Roscar	Ref. Encolar	Escala l/h.	S1 €
25		3/4"	FS25D1X0250M	25-250	230,69
25		3/4"	FS25D1X0400M	40-400	230,69
25		3/4"	FS25D1X0640M	60-640	230,69
25		3/4"	FS25D1X1000M	100-1000	230,69
32		3/8"	FS32D1X0400M	40-400	249,42
32		1"	FS32D1X0640M	60-640	249,42
32		1"	FS32D1X1000M	100-1000	249,42
32		1"	FS32D1X1600M	150-1600	249,42
40		1"	FS40D1X1600M	150-1600	318,81
40		1 1/4"	FS40D1X2500M	200-2500	318,81
40		1 1/4"	FS40D1X4000M	400-4000	318,81
50		1 1/4"	FS50D1X2500M	200-2500	369,41
50		1 1/2"	FS50D1X4000M	400-4000	369,41
50		1 1/2"	FS50D1X5000M	500-5000	369,41
63		2"	FS63D1X4000M	400-4000	480,08
63		2"	FS63D1X6000M	600-6000	480,08
63		2"	FS63D1X0010M	1000-10000	480,08
75			FS75D1X0015M	1500-15000	868,27
75			FS75D1X0020M	2000-20000	868,27
75			FS75D1X0050M	10000-50000	868,27

FLOTADOR PP ROJO CON IMÁN INTERIOR incorporado para contacto exterior (suministrado aparte)

25		3/4"	FS25D1M0150M	15-150	230,69
25		3/4"	FS25D1M0250M	25-250	230,69
25		3/4"	FS25D1M0450M	45-450	230,69
25		3/4"	FS25D1M0700M	70-700	230,69
32		3/8"	FS32D1M0250M	25-250	249,42
32		1"	FS32D1M0400M	40-400	249,42
32		1"	FS32D1M0650M	65-650	249,42
32		1"	FS32D1M1000M	100-1000	249,42
40		1"	FS40D1M1000M	100-1000	318,81
40		1 1/4"	FS40D1M1600M	160-1600	318,81
40		1 1/4"	FS40D1M2500M	200-2500	318,81
50		1 1/4"	FS50D1M1600M	150-1600	369,41
50		1 1/2"	FS50D1M2200M	200-2200	369,41
50		1 1/2"	FS50D1M2500M	250-2500	369,41
63		2"	FS63D1M2500M	250-2500	480,08
63		2"	FS63D1M3500M	350-3500	480,08
63		2"	FS63D1M5000M	500-5000	480,08
75			FS75D1M8000M	1000-8000	868,27
75			FS75D1M0010M	1000-10000	868,27
75			FS75D1M0025M	5000-25000	868,27

 Flujómetro largo para **H₂O**.

Densidad: 1 kg/l - 20° C. Cuerpo: TROGAMID. Juntas: EPDM.

FSIV

encolar.

FLOTADOR INOX AISI 316



Encolar	Diámetro Roscar	Ref. Encolar	Escala l/h.	S1 €
25	3/4"	FS25T1X0250	25-250	153,77
25	3/4"	FS25T1X0400	40-400	153,77
25	3/4"	FS25T1X0640	60-640	153,77
25	3/4"	FS25T1X1000	100-1000	153,77
32	3/8"	FS32T1X0400	40-400	174,40
32	1"	FS32T1X0640	60-640	174,40
32	1"	FS32T1X1000	100-1000	174,40
32	1"	FS32T1X1600	150-1600	174,40
40	1"	FS40T1X1600	150-1600	236,27
40	1 1/4"	FS40T1X2500	200-2500	236,27
40	1 1/4"	FS40T1X4000	400-4000	236,27
50	1 1/4"	FS50T1X2500	200-2500	277,55
50	1 1/2"	FS50T1X4000	400-4000	277,55
50	1 1/2"	FS50T1X5000	500-5000	277,55
63	2"	FS63T1X4000	400-4000	371,32
63	2"	FS63T1X6000	600-6000	371,32
63	2"	FS63T1X0010	1000-10000	371,32
75		FS75T1X0015	1500-15000	646,97
75		FS75T1X0020	2000-20000	646,97
75		FS75T1X0050	10000-50000	646,97

FLOTADOR PP ROJO

25	3/4"	FS25T1M0150	15-150	153,77
25	3/4"	FS25T1M0250	25-250	153,77
25	3/4"	FS25T1M0450	45-450	153,77
25	3/4"	FS25T1M0700	70-700	153,77
32	3/8"	FS32T1M0250	25-250	174,40
32	1"	FS32T1M0400	40-400	174,40
32	1"	FS32T1M0650	65-650	174,40
32	1"	FS32T1M1000	100-1000	174,40
40	1"	FS40T1M1000	100-1000	236,27
40	1 1/4"	FS40T1M1600	160-1600	236,27
40	1 1/4"	FS40T1M2500	200-2500	236,27
50	1 1/4"	FS50T1M1600	150-1600	277,55
50	1 1/2"	FS50T1M2200	200-2200	277,55
50	1 1/2"	FS50T1M2500	250-2500	277,55
63	2"	FS63T1M2500	250-2500	371,32
63	2"	FS63T1M3500	350-3500	371,32
63	2"	FS63T1M5000	500-5000	371,32
75		FS75T1M8000	1000-8000	646,97
75		FS75T1M0010	1000-10000	646,97
75		FS75T1M0025	5000-25000	646,97

Flujómetro largo para H₂O.

Densidad: 1 kg/l - 20° C. Cuerpo: PVC Transparente Juntas: EPDM.

FSIV
 encolar.

FLOTADOR INOX AISI 316 CON IMÁN INTERIOR incorporado para contacto exterior (suministrado aparte)

Encolar	Diámetro Roscar	Ref. Encolar	Escala l/h.	S1 €
25	3/4"	FS25T1X0250M	25-250	223,15
25	3/4"	FS25T1X0400M	40-400	223,15
25	3/4"	FS25T1X0640M	60-640	223,15
25	3/4"	FS25T1X1000M	100-1000	223,15
32	3/8"	FS32T1X0400M	40-400	240,04
32	1"	FS32T1X0640M	60-640	240,04
32	1"	FS32T1X1000M	100-1000	240,04
32	1"	FS32T1X1600M	150-1600	240,04
40	1"	FS40T1X1600M	150-1600	307,56
40	1 1/4"	FS40T1X2500M	200-2500	307,56
40	1 1/4"	FS40T1X4000M	400-4000	307,56
50	1 1/4"	FS50T1X2500M	200-2500	354,46
50	1 1/2"	FS50T1X4000M	400-4000	354,46
50	1 1/2"	FS50T1X5000M	500-5000	354,46
63	2"	FS63T1X4000M	400-4000	459,46
63	2"	FS63T1X6000M	600-6000	459,46
63	2"	FS63T1X0010MF	1000-10000	459,46
75		S75T1X0015MF	1500-15000	834,53
75		S75T1X0020MF	2000-20000	834,53
75		S75T1X0050MF	10000-50000	834,53

FLOTADOR PP ROJO CON IMÁN INTERIOR incorporado para contacto exterior (suministrado aparte)

25	3/4"	FS25T1M0150M	15-150	223,15
25	3/4"	FS25T1M0250M	25-250	223,15
25	3/4"	FS25T1M0450M	45-450	223,15
25	3/4"	FS25T1M0700M	70-700	223,15
32	3/8"	FS32T1M0250M	25-250	240,04
32	1"	FS32T1M0400M	40-400	240,04
32	1"	FS32T1M0650M	65-650	240,04
32	1"	FS32T1M1000M	100-1000	240,04
40	1"	FS40T1M1000M	100-1000	307,56
40	1 1/4"	FS40T1M1600M	160-1600	307,56
40	1 1/4"	FS40T1M2500M	200-2500	307,56
50	1 1/4"	FS50T1M1600M	150-1600	354,46
50	1 1/2"	FS50T1M2200M	200-2200	354,46
50	1 1/2"	FS50T1M2500M	250-2500	354,46
63	2"	FS63T1M2500M	250-2500	459,46
63	2"	FS63T1M3500M	350-3500	459,46
63	2"	FS63T1M5000M	500-5000	459,46
75		FS75T1M8000M	1000-8000	834,53
75		FS75T1M0010M	1000-10000	834,53
75		FS75T1M0025M	5000-25000	834,53

 Flujómetro largo para H₂O.

Densidad: 1 kg/l - 20° C. Cuerpo: PVC Transparente Juntas: EPDM.

FSIV
 encolar.

FLOTADOR INOX AISI 316

Encolar	Diámetro	Roscar	Ref. Encolar	Escala l/h.	S1 €
25		3/4"	FS25P1X0250	25-250	200,65
25		3/4"	FS25P1X0400	40-400	200,65
25		3/4"	FS25P1X0640	60-640	200,65
25		3/4"	FS25P1X1000	100-1000	200,65
32		3/8"	FS32P1X0400	40-400	230,69
32		1"	FS32P1X0640	60-640	230,69
32		1"	FS32P1X1000	100-1000	230,69
32		1"	FS32P1X1600	150-1600	230,69
40		1"	FS40P1X1600	150-1600	298,21
40		1 1/4"	FS40P1X2500	200-2500	298,21
40		1 1/4"	FS40P1X4000	400-4000	298,21
50		1 1/4"	FS50P1X2500	200-2500	365,68
50		1 1/2"	FS50P1X4000	400-4000	365,68
50		1 1/2"	FS50P1X5000	500-5000	365,68
63		2"	FS63P1X4000	400-4000	489,45
63		2"	FS63P1X6000	600-6000	489,45
63		2"	FS63P1X0010	1000-10000	489,45
75			FS75P1X0015	1500-15000	851,40
75			FS75P1X0020	2000-20000	851,40
75			FS75P1X0050	10000-50000	851,40

FLOTADOR PP ROJO

25		3/4"	FS25P1M0150	15-150	200,65
25		3/4"	FS25P1M0250	25-250	200,65
25		3/4"	FS25P1M0450	45-450	200,65
25		3/4"	FS25P1M0700	70-700	200,65
32		3/8"	FS32P1M0250	25-250	230,69
32		1"	FS32P1M0400	40-400	230,69
32		1"	FS32P1M0650	65-650	230,69
32		1"	FS32P1M1000	100-1000	230,69
40		1"	FS40P1M1000	100-1000	298,21
40		1 1/4"	FS40P1M1600	160-1600	298,21
40		1 1/4"	FS40P1M2500	200-2500	298,21
50		1 1/4"	FS50P1M1600	150-1600	365,68
50		1 1/2"	FS50P1M2200	200-2200	365,68
50		1 1/2"	FS50P1M2500	250-2500	365,68
63		2"	FS63P1M2500	250-2500	489,45
63		2"	FS63P1M3500	350-3500	489,45
63		2"	FS63P1M5000	500-5000	489,45
75			FS75P1M8000	1000-8000	851,40
75			FS75P1M0010	1000-10000	851,40
75			FS75P1M0025	5000-25000	851,40

 Flujómetro largo para **H₂O**.

 Densidad: 1 kg/l - 20° C. Cuerpo: **POLYSULFON**. Juntas: **EPDM**.

FSIV
 encolar.

FLOTADOR INOX AISI 316 CON IMÁN INTERIOR incorporado para contacto exterior (suministrado aparte)

Encolar	Diámetro Roscar	Ref. Encolar	Escala l/h.	S1 €
25	3/4"	FS25P1X0250M	25-250	270,04
25	3/4"	FS25P1X0400M	40-400	270,04
25	3/4"	FS25P1X0640M	60-640	270,04
25	3/4"	FS25P1X1000M	100-1000	270,04
32	3/8"	FS32P1X0400M	40-400	296,29
32	1"	FS32P1X0640M	60-640	296,29
32	1"	FS32P1X1000M	100-1000	296,29
32	1"	FS32P1X1600M	150-1600	296,29
40	1"	FS40P1X1600M	150-1600	369,41
40	1 1/4"	FS40P1X2500M	200-2500	369,41
40	1 1/4"	FS40P1X4000M	400-4000	369,41
50	1 1/4"	FS50P1X2500M	200-2500	442,57
50	1 1/2"	FS50P1X4000M	400-4000	442,57
50	1 1/2"	FS50P1X5000M	500-5000	442,57
63	2"	FS63P1X4000M	400-4000	577,60
63	2"	FS63P1X6000M	600-6000	577,60
63	2"	FS63P1X0010M	1000-10000	577,60
75		FS75P1X0015M	1500-15000	1.038,93
75		FS75P1X0020M	2000-20000	1.038,93
75		FS75P1X0050M	10000-50000	1.038,93

FLOTADOR PP ROJO CON IMÁN INTERIOR incorporado para contacto exterior (suministrado aparte)

25	3/4"	FS25P1M0150M	15-150	270,04
25	3/4"	FS25P1M0250M	25-250	270,04
25	3/4"	FS25P1M0450M	45-450	270,04
25	3/4"	FS25P1M0700M	70-700	270,04
32	3/8"	FS32P1M0250M	25-250	296,29
32	1"	FS32P1M0400M	40-400	296,29
32	1"	FS32P1M0650M	65-650	296,29
32	1"	FS32P1M1000M	100-1000	296,29
40	1"	FS40P1M1000M	100-1000	369,41
40	1 1/4"	FS40P1M1600M	160-1600	369,41
40	1 1/4"	FS40P1M2500M	200-2500	369,41
50	1 1/4"	FS50P1M1600M	150-1600	442,57
50	1 1/2"	FS50P1M2200M	200-2200	442,57
50	1 1/2"	FS50P1M2500M	250-2500	442,57
63	2"	FS63P1M2500M	250-2500	577,60
63	2"	FS63P1M3500M	350-3500	577,60
63	2"	FS63P1M5000M	500-5000	577,60
75		FS75P1M8000M	1000-8000	1.038,93
75		FS75P1M0010M	1000-10000	1.038,93
75		FS75P1M0025M	5000-25000	1.038,93

Flujómetro largo para **H₂O**.Densidad: 1 kg/l - 20° C. Cuerpo: **POLYSULFON**. Juntas: **EPDM**.

FSIV
 encolar.

FLOTADOR INOX AISI 316

Encolar	Diámetro Roscar	Ref. Encolar	Escala l/h.	S1 €
25	3/4"	FS25T3X0125	6-125	174,71
25	3/4"	FS25T3X0240	10-240	174,71
25	3/4"	FS25T3X0425	25-425	174,71
25	3/4"	FS25T3X0725	35-725	174,71
32	3/8"	FS32T3X0240	10-240	198,18
32	1"	FS32T3X0420	20-420	198,18
32	1"	FS32T3X0700	25-700	198,18
32	1"	FS32T3X1200	50-1200	198,18
40	1"	FS40T3X1150	50-1150	268,47
40	1 1/4"	FS40T3X1900	100-1900	268,47
40	1 1/4"	FS40T3X3200	200-3200	268,47
50	1 1/4"	FS50T3X1700	100-1700	315,38
50	1 1/2"	FS50T3X3000	200-3000	315,38
50	1 1/2"	FS50T3X3700	200-3700	315,38
63	2"	FS63T3X3000	100-3000	421,94
63	2"	FS63T3X4700	250-4700	421,94
63	2"	FS63T3X8500	500-8500	421,94
75		FS75T3X0012	1000-12000	735,16
75		FS75T3X0165	1500-16500	735,16
75		FS75T3X0043	8800-43000	735,16

FLOTADOR PP ROJO

25	3/4"	FS25T3M0054	2,5-54	174,71
25	3/4"	FS25T3M0115	6-115	174,71
25	3/4"	FS25T3M0235	11-235	174,71
25	3/4"	FS25T3M0410	28-410	174,71
32	3/8"	FS32T3M0125	6-125	198,18
32	1"	FS32T3M0100	10-100	198,18
32	1"	FS32T3M0395	11-395	198,18
32	1"	FS32T3M0650	25-650	198,18
40	1"	FS40T3M0600	25-600	268,47
40	1 1/4"	FS40T3M1100	55-1100	268,47
40	1 1/4"	FS40T3M1700	100-1700	268,47
50	1 1/4"	FS50T3M1000	50-1000	315,38
50	1 1/2"	FS50T3M1500	100-1500	315,38
50	1 1/2"	FS50T3M1600	120-1600	315,38
63	2"	FS63T3M1700	60-1700	421,94
63	2"	FS63T3M2500	90-2500	421,94
63	2"	FS63T3M4000	200-4000	421,94
75		FS75T3M6000	670-6000	735,16
75		FS75T3M7500	500-7500	735,16
75		FS75T3M0022	4400-22000	735,16

 Flujómetro largo para **Hidróxido de sodio (NaOH) 30%..**

 Densidad: 1,33 kg/l - 20° C. Cuerpo **PVC Transparente**. Juntas: **EPDM**.

FSIV
 encolar.

FLOTADOR INOX AISI 316 CON IMÁN INTERIOR incorporado para contacto exterior (suministrado aparte)

Encolar	Diámetro	Roscar	Ref. Encolar	Escala l/h.	S1 €
25		3/4"	FS25T3X0125M	6-125	253,59
25		3/4"	FS25T3X0240M	10-240	253,59
25		3/4"	FS25T3X0425M	25-425	253,59
25		3/4"	FS25T3X0725M	35-725	253,59
32		3/8"	FS32T3X0240M	10-240	272,75
32		1"	FS32T3X0420M	20-420	272,75
32		1"	FS32T3X0700M	25-700	272,75
32		1"	FS32T3X1200M	50-1200	272,75
40		1"	FS40T3X1150M	50-1150	349,48
40		1 1/4"	FS40T3X1900M	100-1900	349,48
40		1 1/4"	FS40T3X3200M	200-3200	349,48
50		1 1/4"	FS50T3X1700M	100-1700	402,76
50		1 1/2"	FS50T3X3000M	200-3000	402,76
50		1 1/2"	FS50T3X3700M	200-3700	402,76
63		2"	FS63T3X3000M	100-3000	522,09
63		2"	FS63T3X4700M	250-4700	522,09
63		2"	FS63T3X8500M	500-8500	522,09
75			FS75T3X0012M	1000-12000	948,26
75			FS75T3X0165M	1500-16500	948,26
75			FS75T3X0043M	8800-43000	948,26

FLOTADOR PP ROJO CON IMÁN INTERIOR incorporado para contacto exterior (suministrado aparte)

25		3/4"	FS25T3M0054M	2,5-54	253,59
25		3/4"	FS25T3M0115M	6-115	253,59
25		3/4"	FS25T3M0235M	11-235	253,59
25		3/4"	FS25T3M0410M	28-410	253,59
32		3/8"	FS32T3M0125M	6-125	272,75
32		1"	FS32T3M0100M	10-100	272,75
32		1"	FS32T3M0395M	11-395	272,75
32		1"	FS32T3M0650M	25-650	272,75
40		1"	FS40T3M0600M	25-600	349,48
40		1 1/4"	FS40T3M1100M	55-1100	349,48
40		1 1/4"	FS40T3M1700M	100-1700	349,48
50		1 1/4"	FS50T3M1000M	50-1000	402,76
50		1 1/2"	FS50T3M1500M	100-1500	402,76
50		1 1/2"	FS50T3M1600M	120-1600	402,76
63		2"	FS63T3M1700M	60-1700	522,09
63		2"	FS63T3M2500M	90-2500	522,09
63		2"	FS63T3M4000M	200-4000	522,09
75			FS75T3M6000M	670-6000	948,26
75			FS75T3M7500M	500-7500	948,26
75			FS75T3M0022M	4400-22000	948,26

 Flujómetro largo para **Hidróxido de sodio (NaOH) 30%..**

 Densidad: 1,33 kg/l - 20° C. Cuerpo **PVC Transparente**. Juntas: **EPDM**.

FSIV
 encolar.

FLOTADOR INOX AISI 316

Encolar	Diámetro	Roscar	Ref. Encolar	Escala l/h.	S1 €
25		3/4"	FS25P3X0125	6-125	228,00
25		3/4"	FS25P3X0240	10-240	228,00
25		3/4"	FS25P3X0425	25-425	228,00
25		3/4"	FS25P3X0725	35-725	228,00
32		3/8"	FS32P3X0240	10-240	262,09
32		1"	FS32P3X0420	20-420	262,09
32		1"	FS32P3X0700	25-700	262,09
32		1"	FS32P3X1200	50-1200	262,09
40		1"	FS40P3X1150	50-1150	338,86
40		1 1/4"	FS40P3X1900	100-1900	338,86
40		1 1/4"	FS40P3X3200	200-3200	338,86
50		1 1/4"	FS50P3X1700	100-1700	415,53
50		1 1/2"	FS50P3X3000	200-3000	415,53
50		1 1/2"	FS50P3X3700	200-3700	415,53
63		2"	FS63P3X3000	100-3000	556,15
63		2"	FS63P3X4700	250-4700	556,15
63		2"	FS63P3X8500	500-8500	556,15
75			FS75P3X0012	1000-12000	967,45
75			FS75P3X0165	1500-16500	967,45
75			FS75P3X0043	8800-43000	967,45

FLOTADOR PP ROJO

25		3/4"	FS25P3M0054	2,5-54	228,00
25		3/4"	FS25P3M0115	6-115	228,00
25		3/4"	FS25P3M0235	11-235	228,00
25		3/4"	FS25P3M0410	28-410	228,00
32		3/8"	FS32P3M0125	6-125	262,09
32		1"	FS32P3M0100	10-100	262,09
32		1"	FS32P3M0395	11-395	262,09
32		1"	FS32P3M0650	25-650	262,09
40		1"	FS40P3M0600	25-600	338,86
40		1 1/4"	FS40P3M1100	55-1100	338,86
40		1 1/4"	FS40P3M1700	100-1700	338,86
50		1 1/4"	FS50P3M1000	50-1000	415,53
50		1 1/2"	FS50P3M1500	100-1500	415,53
50		1 1/2"	FS50P3M1600	120-1600	415,53
63		2"	FS63P3M1700	60-1700	556,15
63		2"	FS63P3M2500	90-2500	556,15
63		2"	FS63P3M4000	200-4000	556,15
75			FS75P3M6000	670-6000	967,45
75			FS75P3M7500	500-7500	967,45
75			FS75P3M0022	4400-22000	967,45

 Flujómetro largo para **Hidróxido de sodio (NaOH) 30%..**

 Densidad: 1,33 kg/l 20° C. Cuerpo: **POLYSULFON**. Juntas: **EPDM**.

FSIV
 encolar.

FLOTADOR INOX AISI 316 CON IMÁN INTERIOR incorporado para contacto exterior (suministrado aparte)

Encolar	Diámetro	Roscar	Ref. Encolar	Escala l/h.	S1 €
25		3/4"	FS25P3X0125M	6-125	306,87
25		3/4"	FS25P3X0240M	10-240	306,87
25		3/4"	FS25P3X0425M	25-425	306,87
25		3/4"	FS25P3X0725M	35-725	306,87
32		3/8"	FS32P3X0240M	10-240	336,67
32		1"	FS32P3X0420M	20-420	336,67
32		1"	FS32P3X0700M	25-700	336,67
32		1"	FS32P3X1200M	50-1200	336,67
40		1"	FS40P3X1150M	50-1150	419,77
40		1 1/4"	FS40P3X1900M	100-1900	419,77
40		1 1/4"	FS40P3X3200M	200-3200	419,77
50		1 1/4"	FS50P3X1700M	100-1700	502,90
50		1 1/2"	FS50P3X3000M	200-3000	502,90
50		1 1/2"	FS50P3X3700M	200-3700	502,90
63		2"	FS63P3X3000M	100-3000	656,34
63		2"	FS63P3X4700M	250-4700	656,34
63		2"	FS63P3X8500M	500-8500	656,34
75			FS75P3X0012M	1000-12000	1.180,56
75			FS75P3X0165M	1500-16500	1.180,56
75			FS75P3X0043M	8800-43000	1.180,56

FLOTADOR PP ROJO CON IMÁN INTERIOR incorporado para contacto exterior (suministrado aparte)

25		3/4"	FS25P3M0054M	2,5-54	306,87
25		3/4"	FS25P3M0115M	6-115	306,87
25		3/4"	FS25P3M0235M	11-235	306,87
25		3/4"	FS25P3M0410M	28-410	306,87
32		3/8"	FS32P3M0125M	6-125	336,67
32		1"	FS32P3M0100M	10-100	336,67
32		1"	FS32P3M0395M	11-395	336,67
32		1"	FS32P3M0650M	25-650	336,67
40		1"	FS40P3M0600M	25-600	419,77
40		1 1/4"	FS40P3M1100M	55-1100	419,77
40		1 1/4"	FS40P3M1700M	100-1700	419,77
50		1 1/4"	FS50P3M1000M	50-1000	502,90
50		1 1/2"	FS50P3M1500M	100-1500	502,90
50		1 1/2"	FS50P3M1600M	120-1600	502,90
63		2"	FS63P3M1700M	60-1700	656,34
63		2"	FS63P3M2500M	90-2500	656,34
63		2"	FS63P3M4000M	200-4000	656,34
75			FS75P3M6000M	670-6000	1.180,56
75			FS75P3M7500M	500-7500	1.180,56
75			FS75P3M0022M	4400-22000	1.180,56

 Flujómetro largo para **Hidróxido de sodio (NaOH) 30%..**

 Densidad: 1,33 kg/l 20° C. Cuerpo: **POLYSULFON**. Juntas: **EPDM**.

FSIV
 encolar.

FLOTADOR INOX AISI 316

Encolar	Diámetro	Roscar	Ref. Encolar	Escala l/h.	S1 €
25		3/4"	FS25T5X0027	1-27	174,71
25		3/4"	FS25T5X0070	2,5-70	174,71
25		3/4"	FS25T5X0170	5-170	174,71
25		3/4"	FS25T5X0350	15-350	174,71
32		3/8"	FS32T5X0065	2,5-65	198,18
32		1"	FS32T5X0145	5-145	198,18
32		1"	FS32T5X0330	10-330	198,18
32		1"	FS32T5X0675	25-675	198,18
40		1"	FS40T5X0550	25-550	268,47
40		1 1/4"	FS40T5X1100	50-1100	268,47
40		1 1/4"	FS40T5X2000	100-2000	268,47
50		1 1/4"	FS50T5X1000	50-1000	315,38
50		1 1/2"	FS50T5X1900	50-1900	315,38
50		1 1/2"	FS50T5X2500	100-2500	315,38
63		2"	FS63T5X1800	50-1800	421,94
63		2"	FS63T5X3100	100-3100	421,94
63		2"	FS63T5X6000	250-6000	421,94
75			FS75T5X9000	250-9000	735,16
75			FS75T5X0125	500-12500	735,16
75			FS75T5X0040	8200-40000	735,16

FLOTADOR PP ROJO

25		3/4"	FS25T5M0095	0,5-9,5	174,71
25		3/4"	FS25T5M0023	1,5-23	174,71
25		3/4"	FS25T5M0065	3-65	174,71
25		3/4"	FS25T5M0145	7-145	174,71
32		3/8"	FS32T5M0020	1-20	198,18
32		1"	FS32T5M0050	2,5-50	198,18
32		1"	FS32T5M0130	5,5-130	198,18
32		1"	FS32T5M0260	10-260	198,18
40		1"	FS40T5M0200	10-200	268,47
40		1 1/4"	FS40T5M0500	20-500	268,47
40		1 1/4"	FS40T5M0950	25-950	268,47
50		1 1/4"	FS50T5M0425	25-425	315,38
50		1 1/2"	FS50T5M0800	25-800	315,38
50		1 1/2"	FS50T5M0950	40-950	315,38
63		2"	FS63T5M0800	30-800	421,94
63		2"	FS63T5M1400	40-1400	421,94
63		2"	FS63T5M2500	80-2500	421,94
75			FS75T5M3800	330-3800	735,16
75			FS75T5M5200	170-5200	735,16
75			FS75T5M0020	4100-20000	735,16

 Flujómetro largo para **Hidróxido de sodio (NaOH) 50%..**

Densidad: 1,53 kg/l - 20° C. Cuerpo PVC Transparente. Juntas: EPDM.

FSIV
 encolar.

FLOTADOR INOX AISI 316 CON IMÁN INTERIOR incorporado para contacto exterior (suministrado aparte)

Encolar	Diámetro Roscar	Ref. Encolar	Escala l/h.	S1 €
25	3/4"	FS25T5X0027M	1-27	253,59
25	3/4"	FS25T5X0070M	2,5-70	253,59
25	3/4"	FS25T5X0170M	5-170	253,59
25	3/4"	FS25T5X0350M	15-350	253,59
32	3/8"	FS32T5X0065M	2,5-65	272,75
32	1"	FS32T5X0145M	5-145	272,75
32	1"	FS32T5X0330M	10-330	272,75
32	1"	FS32T5X0675M	25-675	272,75
40	1"	FS40T5X0550M	25-550	349,48
40	1 1/4"	FS40T5X1100M	50-1100	349,48
40	1 1/4"	FS40T5X2000M	100-2000	349,48
50	1 1/4"	FS50T5X1000M	50-1000	402,76
50	1 1/2"	FS50T5X1900M	50-1900	402,76
50	1 1/2"	FS50T5X2500M	100-2500	402,76
63	2"	FS63T5X1800M	50-1800	522,09
63	2"	FS63T5X3100M	100-3100	522,09
63	2"	FS63T5X6000M	250-6000	522,09
75		FS75T5X9000M	250-9000	948,26
75		FS75T5X0125M	500-12500	948,26
75		FS75T5X0040M	8200-40000	948,26

FLOTADOR PP ROJO CON IMÁN INTERIOR

incorporado para contacto exterior (suministrado aparte)

25	3/4"	FS25T5M0095M	0,5-9,5	253,59
25	3/4"	FS25T5M0023M	1,5-23	253,59
25	3/4"	FS25T5M0065M	3-65	253,59
25	3/4"	FS25T5M0145M	7-145	253,59
32	3/8"	FS32T5M0020M	1-20	272,75
32	1"	FS32T5M0050M	2,5-50	272,75
32	1"	FS32T5M0130M	5,5-130	272,75
32	1"	FS32T5M0260M	10-260	272,75
40	1"	FS40T5M0200M	10-200	349,48
40	1 1/4"	FS40T5M0500M	20-500	349,48
40	1 1/4"	FS40T5M0950M	25-950	349,48
50	1 1/4"	FS50T5M0425M	25-425	402,76
50	1 1/2"	FS50T5M0800M	25-800	402,76
50	1 1/2"	FS50T5M0950M	40-950	402,76
63	2"	FS63T5M0800M	30-800	522,09
63	2"	FS63T5M1400M	40-1400	522,09
63	2"	FS63T5M2500M	80-2500	522,09
75		FS75T5M3800M	330-3800	948,26
75		FS75T5M5200M	170-5200	948,26
75		FS75T5M0020M	4100-20000	948,26

 Flujómetro largo para **Hidróxido de sodio (NaOH) 50%..**

 Densidad: 1,53 kg/l - 20° C. Cuerpo **PVC Transparente**. Juntas: **EPDM**.

FSIV
 encolar.

FLOTADOR INOX AISI 316

Encolar	Diámetro	Roscar	Ref. Encolar	Escala l/h.	S1 €
25		3/4"	FS25P5X0027	1-27	228,00
25		3/4"	FS25P5X0070	2,5-70	228,00
25		3/4"	FS25P5X0170	5-170	228,00
25		3/4"	FS25P5X0350	15-350	228,00
32		3/8"	FS32P5X0065	2,5-65	262,09
32		1"	FS32P5X0145	5-145	262,09
32		1"	FS32P5X0330	10-330	262,09
32		1"	FS32P5X0675	25-675	262,09
40		1"	FS40P5X0550	25-550	338,86
40		1 1/4"	FS40P5X1100	50-1100	338,86
40		1 1/4"	FS40P5X2000	100-2000	338,86
50		1 1/4"	FS50P5X1000	50-1000	415,53
50		1 1/2"	FS50P5X1900	50-1900	415,53
50		1 1/2"	FS50P5X2500	100-2500	415,53
63		2"	FS63P5X1800	50-1800	556,15
63		2"	FS63P5X3100	100-3100	556,15
63		2"	FS63P5X6000	250-6000	556,15
75			FS75P5X9000	250-9000	967,45
75			FS75P5X0125	500-12500	967,45
75			FS75P5X0040	8200-40000	967,45

FLOTADOR PP ROJO

25		3/4"	FS25P5M0095	0,5-9,5	228,00
25		3/4"	FS25P5M0023	1,5-23	228,00
25		3/4"	FS25P5M0065	3-65	228,00
25		3/4"	FS25P5M0145	7-145	228,00
32		3/8"	FS32P5M0020	1-20	262,09
32		1"	FS32P5M0050	2,5-50	262,09
32		1"	FS32P5M0130	5,5-130	262,09
32		1"	FS32P5M0260	10-260	262,09
40		1"	FS40P5M0200	10-200	338,86
40		1 1/4"	FS40P5M0500	20-500	338,86
40		1 1/4"	FS40P5M0950	25-950	338,86
50		1 1/4"	FS50P5M0425	25-425	415,53
50		1 1/2"	FS50P5M0800	25-800	415,53
50		1 1/2"	FS50P5M0950	40-950	415,53
63		2"	FS63P5M0800	30-800	556,15
63		2"	FS63P5M1400	40-1400	556,15
63		2"	FS63P5M2500	80-2500	556,15
75			FS75P5M3800	330-3800	967,45
75			FS75P5M5200	170-5200	967,45
75			FS75P5M0020	4100-20000	967,45

 Flujómetro largo para **Hidróxido de sodio (NaOH) 50%..**

 Densidad: 1,53 kg/l - 20° C. Cuerpo **POLYSULFON** Juntas: **EPDM**.

FSIV
 encolar.

FLOTADOR INOX AISI 316 CON IMÁN INTERIOR incorporado para contacto exterior (suministrado aparte)

Encolar	Diámetro	Roscar	Ref. Encolar	Escala l/h.	S1 €
25		3/4"	FS25P5X0027M	1-27	306,87
25		3/4"	FS25P5X0070M	2,5-70	306,87
25		3/4"	FS25P5X0170M	5-170	306,87
25		3/4"	FS25P5X0350M	15-350	306,87
32		3/8"	FS32P5X0065M	2,5-65	336,67
32		1"	FS32P5X0145M	5-145	336,67
32		1"	FS32P5X0330M	10-330	336,67
32		1"	FS32P5X0675M	25-675	336,67
40		1"	FS40P5X0550M	25-550	419,77
40		1 1/4"	FS40P5X1100M	50-1100	419,77
40		1 1/4"	FS40P5X2000M	100-2000	419,77
50		1 1/4"	FS50P5X1000M	50-1000	502,90
50		1 1/2"	FS50P5X1900M	50-1900	502,90
50		1 1/2"	FS50P5X2500M	100-2500	502,90
63		2"	FS63P5X1800M	50-1800	656,34
63		2"	FS63P5X3100M	100-3100	656,34
63		2"	FS63P5X6000M	250-6000	656,34
75			FS75P5X9000M	250-9000	1.180,56
75			FS75P5X0125M	500-12500	1.180,56
75			FS75P5X0040M	8200-40000	1.180,56

FLOTADOR PP ROJO CON IMÁN INTERIOR incorporado para contacto exterior (suministrado aparte)

25		3/4"	FS25P5M0095M	0,5-9,5	306,87
25		3/4"	FS25P5M0023M	1,5-23	306,87
25		3/4"	FS25P5M0065M	3-65	306,87
25		3/4"	FS25P5M0145M	7-145	306,87
32		3/8"	FS32P5M0020M	1-20	336,67
32		1"	FS32P5M0050M	2,5-50	336,67
32		1"	FS32P5M0130M	5,5-130	336,67
32		1"	FS32P5M0260M	10-260	336,67
40		1"	FS40P5M0200M	10-200	419,77
40		1 1/4"	FS40P5M0500M	20-500	419,77
40		1 1/4"	FS40P5M0950M	25-950	419,77
50		1 1/4"	FS50P5M0425M	25-425	502,90
50		1 1/2"	FS50P5M0800M	25-800	502,90
50		1 1/2"	FS50P5M0950M	40-950	502,90
63		2"	FS63P5M0800M	30-800	656,34
63		2"	FS63P5M1400M	40-1400	656,34
63		2"	FS63P5M2500M	80-2500	656,34
75			FS75P5M3800M	330-3800	1.180,56
75			FS75P5M5200M	170-5200	1.180,56
75			FS75P5M0020M	4100-20000	1.180,56

 Flujómetro largo para **Hidróxido de sodio (NaOH) 50%..**

 Densidad: 1,53 kg/l - 20° C. Cuerpo **POLYSULFON** Juntas: **EPDM**.

FSIV
 encolar.

FLOTADOR PP ROJO

Encolar	Diámetro	Roscar	Ref. Encolar	Escala l/h.	S1 €
25		3/4"	FS25T2M0140	14-140	174,71
25		3/4"	FS25T2M0230	23-230	174,71
25		3/4"	FS25T2M0420	42-420	174,71
25		3/4"	FS25T2M0650	65-650	174,71
32		3/8"	FS32T2M0230	23-230	198,18
32		1"	FS32T2M0370	37-370	198,18
32		1"	FS32T2M0600	60-600	198,18
32		1"	FS32T2M0900	90-900	198,18
40		1"	FS40T2M0900	90-900	268,47
40		1 1/4"	FS40T2M1500	150-1500	268,47
40		1 1/4"	FS40T2M2300	200-2300	268,47
50		1 1/4"	FS50T2M1500	140-1500	315,38
50		1 1/2"	FS50T2M2000	190-2000	315,38
50		1 1/2"	FS50T2M2300	230-2300	315,38
63		2"	FS63T2M2300	230-2300	421,94
63		2"	FS63T2M3200	330-3200	421,94
63		2"	FS63T2M4600	470-4600	421,94
75			FS75T2M7500	950-7500	735,16
75			FS75T2M9300	930-9300	735,16
75			FS75T2M0023	4700-23000	735,16

FLOTADOR PP ROJO CON IMÁN INTERIOR incorporado para contacto exterior (suministrado aparte)

25		3/4"	FS25T2M0140M	14-140	253,59
25		3/4"	FS25T2M0230M	23-230	253,59
25		3/4"	FS25T2M0420M	42-420	253,59
25		3/4"	FS25T2M0650M	65-650	253,59
32		3/8"	FS32T2M0230M	23-230	272,75
32		1"	FS32T2M0370M	37-370	272,75
32		1"	FS32T2M0600M	60-600	272,75
32		1"	FS32T2M0900M	90-900	272,75
40		1"	FS40T2M0900M	90-900	349,48
40		1 1/4"	FS40T2M1500M	150-1500	349,48
40		1 1/4"	FS40T2M2300M	200-2300	349,48
50		1 1/4"	FS50T2M1500M	140-1500	402,76
50		1 1/2"	FS50T2M2000M	190-2000	402,76
50		1 1/2"	FS50T2M2300M	230-2300	402,76
63		2"	FS63T2M2300M	230-2300	522,09
63		2"	FS63T2M3200M	330-3200	522,09
63		2"	FS63T2M4600M	470-4600	522,09
75			FS75T2M7500M	950-7500	948,26
75			FS75T2M9300M	930-9300	948,26
75			FS75T2M0023M	4700-23000	948,26

 Flujómetro largo para **Ácido clorhídrico (HCl) 30-33%**.

 Densidad: 1,16 kg/l - 20° C. Cuerpo **PVC Transparente**. Juntas: **EPDM**.

FSIV
 encolar.

FLOTADOR PP ROJO

Encolar	Diámetro	Roscar	Ref. Encolar	Escala l/h.	S1 €
25		3/4"	FS25P2M0140	14-140	228,00
25		3/4"	FS25P2M0230	23-230	228,00
25		3/4"	FS25P2M0420	42-420	228,00
25		3/4"	FS25P2M0650	65-650	228,00
32		3/8"	FS32P2M0230	23-230	262,09
32		1"	FS32P2M0370	37-370	262,09
32		1"	FS32P2M0600	60-600	262,09
32		1"	FS32P2M0900	90-900	262,09
40		1"	FS40P2M0900	90-900	338,86
40		1 1/4"	FS40P2M1500	150-1500	338,86
40		1 1/4"	FS40P2P2300	200-2300	338,86
50		1 1/4"	FS50P2M1500	140-1500	415,53
50		1 1/2"	FS50P2P2000	190-2000	415,53
50		1 1/2"	FS50P2P2300	230-2300	415,53
63		2"	FS63P2P2300	230-2300	556,15
63		2"	FS63P2M3200	330-3200	556,15
63		2"	FS63P2M4600	470-4600	556,15
75			FS75P2M7500	950-7500	967,45
75			FS75P2M9300	930-9300	967,45
75			FS75P2M0023	4700-23000	967,45

FLOTADOR PP ROJO CON IMÁN INTERIOR incorporado para contacto exterior (suministrado aparte)

25		3/4"	FS25P2M0140M	14-140	306,87
25		3/4"	FS25P2M0230M	23-230	306,87
25		3/4"	FS25P2M0420M	42-420	306,87
25		3/4"	FS25P2M0650M	65-650	306,87
32		3/8"	FS32P2M0230M	23-230	336,67
32		1"	FS32P2M0370M	37-370	336,67
32		1"	FS32P2M0600M	60-600	336,67
32		1"	FS32P2M0900M	90-900	336,67
40		1"	FS40P2M0900M	90-900	419,77
40		1 1/4"	FS40P2M1500M	150-1500	419,77
40		1 1/4"	FS40P2M2300M	200-2300	419,77
50		1 1/4"	FS50P2M1500M	140-1500	502,90
50		1 1/2"	FS50P2M2000M	190-2000	502,90
50		1 1/2"	FS50P2M2300M	230-2300	502,90
63		2"	FS63P2M2300M	230-2300	656,34
63		2"	FS63P2M3200M	330-3200	656,34
63		2"	FS63P2M4600M	470-4600	656,34
75			FS75P2M7500M	950-7500	1.180,56
75			FS75P2M9300M	930-9300	1.180,56
75			FS75P2M0023M	4700-23000	1.180,56

 Flujómetro largo para **Ácido clorhídrico (HCl) 30-33%**.

 Densidad: 1,16 kg/l - 20° C. Cuerpo **POLYSULFON** Juntas: **EPDM**.

FSIV
 encolar.

FLOTADOR PP ROJO

Encolar	Diámetro	Roscar	Ref. Encolar	Escala Nm ³ /h	S1 €
25		3/4"	FS25D0M0025	0,2-2,5	191,78
25		3/4"	FS25D0M0004	0,3-4	191,78
25		3/4"	FS25D0M0065	0,5-6,5	191,78
25		3/4"	FS25D0M0010	1-10	191,78
32		1"	FS32D0M0004	0,4-4	215,21
32		1"	FS32D0M0065	0,5-6,5	215,21
32		1"	FS32D0M0010	1-10	215,21
32		1"	FS32D0M0016	1,5-16	215,21
40		1 1/4"	FS40D0M0016	1,5-16	287,67
40		1 1/4"	FS40D0M0025	2-25	287,67
40		1 1/4"	FS40D0M0040	4-40	287,67
50		1 1/2"	FS50D0M0025	2-25	334,56
50		1 1/2"	FS50D0M0040	4-40	334,56
50		1 1/2"	FS50D0M0050	5-50	334,56
63		2"	FS63D0M0040	4-40	436,80
63		2"	FS63D0M0064	6-64	436,80
63		2"	FS63D0M0100	10-100	436,80
75			FS75D0M0140	15-140	747,95
75			FS75D0M0200	20-200	747,95

FLOTADOR PP ROJO CON IMÁN INTERIOR incorporado para contacto exterior (suministrado aparte)

25		3/4"	FS25D0M0025M	0,2-2,5	270,63
25		3/4"	FS25D0M0004M	0,3-4	270,63
25		3/4"	FS25D0M0065M	0,5-6,5	270,63
25		3/4"	FS25D0M0010M	1-10	270,63
32		1"	FS32D0M0004M	0,4-4	289,81
32		1"	FS32D0M0065M	0,5-6,5	289,81
32		1"	FS32D0M0010M	1-10	289,81
32		1"	FS32D0M0016M	1,5-16	289,81
40		1 1/4"	FS40D0M0016M	1,5-16	368,66
40		1 1/4"	FS40D0M0025M	2-25	368,66
40		1 1/4"	FS40D0M0040M	4-40	368,66
50		1 1/2"	FS50D0M0025M	2-25	380,42
50		1 1/2"	FS50D0M0040M	4-40	380,42
50		1 1/2"	FS50D0M0050M	5-50	380,42
63		2"	FS63D0M0040M	4-40	537,01
63		2"	FS63D0M0064M	6-64	537,01
63		2"	FS63D0M0100M	10-100	537,01
75			FS75D0M0140M	15-140	952,71
75			FS75D0M0200M	20-200	952,71

 Flujómetro largo para **Aire**.

 Densidad: 1,013 bar abs - 20° C. Cuerpo: **TROGAMID**. Juntas: **EPDM**.



Ref.	Descripción	S1 €
MSMIN01	Contacto de MÍNIMA para flujómetros FS *	127,54
MSMAX01	Contacto de MAXIMA para flujómetros FS *	127,54
	Escala especial	Consultar
	Doble escala	Consultar

Contactos exteriores.

Sólo utilizables con flujómetros que incorporen imán exterior.

* Para usar con flotador con imán incorporado.



d	Ref.	Descripción	€
25	QBIC025	Manguito C-PVC	10,47
32	QBIC032	Manguito C-PVC	13,61
40	QBIC040	Manguito C-PVC	16,69
50	QBIC050	Manguito C-PVC	22,22
63	QBIC063	Manguito C-PVC	29,66
25	QBIGM025	Manguito PP-H	3,87
32	QBIGM032	Manguito PP-H	4,13
40	QBIGM040	Manguito PP-H	5,11
50	QBIGM050	Manguito PP-H	6,11
63	QBIGM063	Manguito PP-H	6,50
25	QBIGF025	Manguito PVDF	19,15
32	QBIGF032	Manguito PVDF	21,33
40	QBIGF040	Manguito PVDF	27,22
50	QBIGF050	Manguito PVDF	31,01
63	QBIGF063	Manguito PVDF	43,01

Manguitos.

Para cada flujómetro es necesario pedir 2 manguitos.

d	Ref.	Descripción	€
25	OR4112F	Junta FKM	2,51
32	OR4131F	Junta FKM	7,10
40	OR0150F	Junta FKM	13,97
50	OR4200F	Junta FKM	10,90
63	OR4275F	Junta FKM	17,34
75	OR6325F	Junta FKM	27,83

Juntas.

Para cada flujómetro es necesario pedir 2 juntas.

d	Ref.	Descripción	€
25	EFC114	Tuerca C-PVC	9,27
32	EFC112	Tuerca C-PVC	13,44
40	EFC200	Tuerca C-PVC	15,29
50	EFC214	Tuerca C-PVC	25,05
63	EFC234	Tuerca C-PVC	35,72
25	EFGM114	Tuerca PP-H	7,54
32	EFGM112	Tuerca PP-H	8,75
40	EFGM200	Tuerca PP-H	11,17
50	EFGM214	Tuerca PP-H	17,30
63	EFGM234	Tuerca PP-H	27,89
25	EFGF114	Tuerca PVDF	33,29
32	EFGF112	Tuerca PVDF	41,28
40	EFGF200	Tuerca PVDF	56,75
50	EFGF214	Tuerca PVDF	82,76
63	EFGF234	Tuerca PVDF	128,69

Tuercas.

Para cada flujómetro es necesario pedir 2 tuercas.

Bajo pedido disponemos también de conexiones rosca hembra de 3/8" a 1" en acero inoxidable AISI 316 y en acero al carbono.



INDUSTRIA

Medición

Medidores electrónicos de caudal



M9.02

Ref.	Montaje	Salidas	Voltaje	R	€
M9.02.P1	En panel	1x(4-20mA), 2x(S.S.R.), 1 relé	12-24 VDC		873,12
M9.02.W1	En pared	1x(4-20mA), 2x(S.S.R.), 1 relé	12-24 VDC		1.010,23
M9.02.W2	En pared	1x(4-20mA), 2x(S.S.R.), 1 relé'	110-230 VAC		1.139,73

Monitor y transmisor de caudal.

Para sensores de caudal.



M9.02

Ref.	Longitud sensor	Material sensor	Juntas	Voltaje	R	€
M9.02.01	L0	C-PVC	EPDM	12-24 VDC		1.473,82
M9.02.02	L0	C-PVC	FKM	12-24 VDC		1.473,82
M9.02.03	L1	PVDF	EPDM	12-24 VDC		1.497,22
M9.02.04	L1	PVDF	FKM	12-24 VDC		1.497,22
M9.02.05	L0	PVDF	EPDM	12-24 VDC		1.629,81
M9.02.06	L0	PVDF	FKM	12-24 VDC		1.629,81
M9.02.07	L1	PVDF	EPDM	12-24 VDC		1.873,56
M9.02.08	L1	PVDF	FKM	12-24 VDC		1.873,56
M9.02.09	L0	INOX 316 L	EPDM	12-24 VDC		1.856,58
M9.02.10	L0	INOX 316 L	FKM	12-24 VDC		1.856,58
M9.02.11	L1	INOX 316 L	EPDM	12-24 VDC		1.898,24
M9.02.12	L1	INOX 316 L	FKM	12-24 VDC		1.898,24

Monitor y transmisor de caudal

con sensor de paletas

Montaje directo y compacto. Salidas 1x(4-20mA), 2x(S.S.R.), 1 relé.



M9.00

Ref.	Montaje	Salidas	Voltaje	R	€
M9.00.P1	En panel	1x(4-20mA), 1x(S.S.R.)	12-24 VDC		785,89
M9.00.W1	En pared	1x(4-20mA), 1x(S.S.R.)	12-24 VDC		923,04
M9.00.W2	En pared	1x(4-20mA), 1x(S.S.R.)	110-230 VAC		1.052,55

Monitor y transmisor de caudal **2 HILOS.**

Para sensores de caudal.



M9.00

Ref.	Longitud sensor	Material sensor	Juntas	Voltaje	R	€
M9.00.01	L0	C-PVC	EPDM	12-24 VDC		1.376,98
M9.00.02	L0	C-PVC	FKM	12-24 VDC		1.376,98
M9.00.03	L1	PVDF	EPDM	12-24 VDC		1.400,40
M9.00.04	L1	PVDF	FKM	12-24 VDC		1.400,40
M9.00.05	L0	PVDF	EPDM	12-24 VDC		1.532,99
M9.00.06	L0	PVDF	FKM	12-24 VDC		1.532,99
M9.00.07	L1	PVDF	EPDM	12-24 VDC		1.776,76
M9.00.08	L1	PVDF	FKM	12-24 VDC		1.776,76
M9.00.09	L0	INOX 316 L	EPDM	12-24 VDC		1.759,78
M9.00.10	L0	INOX 316 L	FKM	12-24 VDC		1.759,78
M9.00.11	L1	INOX 316 L	EPDM	12-24 VDC		1.801,43
M9.00.12	L1	INOX 316 L	FKM	12-24 VDC		1.801,43

Monitor y transmisor de caudal **2 HILOS.**

con sensor de paletas

Montaje directo y compacto. Salidas 1x(4-20mA), 2x(S.S.R.).

Longitud L0 para diámetros de ø 20-110 mm. Longitud L1 para diámetros de 125-450 mm.

El pedido estándar se compone de sensor + pantalla + accesorios de conexión al tubo. Disponemos de instrucciones de funcionamiento de los modelos.

M9.20



R

Ref.	Montaje	€
M9.20.P1	En panel	903,77
M9.20.W1	En pared	1.040,92

Monitor de caudal. **A BATERÍAS.**

Para sensores de caudal.

M9.20



R

Ref.	Longitud sensor	Material sensor	Juntas	€
M9.20.01	L0	C-PVC	EPDM	1.507,93
M9.20.02	L0	C-PVC	FKM	1.507,93
M9.20.03	L1	PVDF	EPDM	1.531,34
M9.20.04	L1	PVDF	FKM	1.531,34
M9.20.05	L0	PVDF	EPDM	1.663,94
M9.20.06	L0	PVDF	FKM	1.663,94
M9.20.07	L1	PVDF	EPDM	1.907,72
M9.20.08	L1	PVDF	FKM	1.907,72
M9.20.09	L0	INOX 316 L	EPDM	1.890,76
M9.20.10	L0	INOX 316 L	FKM	1.890,76
M9.20.11	L1	INOX 316 L	EPDM	1.932,40
M9.20.12	L1	INOX 316 L	FKM	1.932,40

Monitor de caudal con sensor de paletas **A BATERÍAS.**

Montaje directo y compacto.

R

M9.50



Ref.	Montaje	Salidas	Voltaje	€
M9.50.P1	En panel	2x(4-20mA), 2x(S.S.R.), 2 relés	12-24 VDC	1.204,79
M9.50.W1	En pared	2x(4-20mA), 2x(S.S.R.), 2 relés	12-24 VDC	1.378,01
M9.50.W2	En pared	2x(4-20mA), 2x(S.S.R.), 2 relés	110-230 VAC	1.543,42

Monitor de control de trasvase. Para sensores de caudal.

M9.03



R

Ref.	Montaje	Salidas	Voltaje	€
M9.00.P1	En panel	2x(4-20mA), 2x(S.S.R.), 2 relés	12-24 VDC	1.553,58
M9.00.W1	En pared	2x(4-20mA), 2x(S.S.R.), 2 relés	12-24 VDC	1.736,40
M9.00.W2	En pared	2x(4-20mA), 2x(S.S.R.), 2 relés	110-230 VAC	1.909,08

Monitor y transmisor de caudal **DOBLE** Para sensores de caudal.

M9.05



R

Ref.	Montaje	Salidas	Voltaje	€
M9.05.P1	En panel	2x(4-20mA), 2x(S.S.R.), 2 relés	12-24 VDC	1.161,90
M9.05.W1	En pared	2x(4-20mA), 2x(S.S.R.), 2 relés	12-24 VDC	1.344,69
M9.05.W2	En pared	2x(4-20mA), 2x(S.S.R.), 2 relés	110-230 VAC	1.517,33

Monitor y transmisor de conductividad. Para sensores de conductividad.

Longitud L0 para diámetros de ø 20-110 mm. Longitud L1 para diámetros de 125-450 mm.

El pedido estándar se compone de sensor + pantalla + accesorios de conexión al tubo. Disponemos de instrucciones de funcionamiento de los modelos.

M9.06



R

Ref.	Montaje	Salidas	Voltaje	€
M9.06.P1	En panel	2x(4-20mA), 2x(S.S.R.), 2 relés	12-24 VDC	1.171,26
M9.06.W1	En pared	2x(4-20mA), 2x(S.S.R.), 2 relés	12-24 VDC	1.354,06
M9.06.W2	En pared	2x(4-20mA), 2x(S.S.R.), 2 relés	110-230 VAC	1.526,67

Monitor y transmisor de pH / ORP.

Para sensores de pH/ORP.

M9.07



R

Ref.	Montaje	Salidas	Voltaje	€
M9.00.P1	En panel	2x(4-20mA), 2x(S.S.R.), 2 relés	12-24 VDC	1.551,40
M9.00.W1	En pared	2x(4-20mA), 2x(S.S.R.), 2 relés	12-24 VDC	1.734,30
M9.00.W2	En pared	2x(4-20mA), 2x(S.S.R.), 2 relés	110-230 VAC	1.906,97

Monitor y transmisor de doble par metro: **CONDUCTIVIDAD - CAUDAL.**

M9.08



R

Ref.	Montaje	Salidas	Voltaje	€
M9.00.P1	En panel	2x(4-20mA), 2x(S.S.R.), 2 relés	12-24 VDC	1.560,84
M9.00.W1	En pared	2x(4-20mA), 2x(S.S.R.), 2 relés	12-24 VDC	1.743,65
M9.00.W2	En pared	2x(4-20mA), 2x(S.S.R.), 2 relés	110-230 VAC	1.916,30

Monitor y transmisor de doble par metro: **pH / ORP - CAUDAL.**

M9.10



R

Ref.	Montaje	Salidas	Voltaje	€
M9.00.P1	En panel	2x(4-20mA), 2x(S.S.R.), 2 relés	12-24 VDC	1.480,34
M9.00.W1	En pared	2x(4-20mA), 2x(S.S.R.), 2 relés	12-24 VDC	1.663,15
M9.00.W2	En pared	2x(4-20mA), 2x(S.S.R.), 2 relés	110-230 VAC	1.835,83

Monitor y transmisor analógico de doble parámetro.

Longitud L0 para diámetros de ø 20-110 mm. Longitud L1 para diámetros de 125-450 mm.

El pedido estándar se compone de sensor + pantalla + accesorios de conexión al tubo. Disponemos de instrucciones de funcionamiento de los modelos.



INDUSTRIA

Medición Sensores de caudal



F3.00.H.XX

Ref.	Longitud sensor	Material sensor	Juntas	Protección	€
F3.00.H.01	L0	C-PVC	EPDM	IP68	410,86
F3.00.H.02	L0	C-PVC	FKM	IP68	410,86
F3.00.H.03	L1	C-PVC	EPDM	IP68	431,35
F3.00.H.04	L1	C-PVC	FKM	IP68	431,35
F3.00.H.05	L0	PVDF	EPDM	IP68	549,78
F3.00.H.06	L0	PVDF	FKM	IP68	549,78
F3.00.H.07	L1	PVDF	EPDM	IP68	713,55
F3.00.H.08	L1	PVDF	FKM	IP68	713,55
F3.00.H.09	L0	INOX 316	EPDM	IP68	769,40
F3.00.H.10	L0	INOX 316	FKM	IP68	769,40
F3.00.H.11	L1	INOX 316	EPDM	IP68	807,75
F3.00.H.12	L1	INOX 316	FKM	IP68	807,75

Sensor de caudal de paletas version remota

Alimentación 12-24 VDC. **VERSIÓN HALL.**



Ref.	Longitud sensor	Material sensor	Juntas	Protección	€
F3.00.H.13	L0	C-PVC	EPDM	IP65	410,86
F3.00.H.14	L0	C-PVC	FKM	IP65	410,86
F3.00.H.15	L1	PVDF	EPDM	IP65	431,35
F3.00.H.16	L1	PVDF	FKM	IP65	431,35
F3.00.H.17	L0	PVDF	EPDM	IP65	549,78
F3.00.H.18	L0	PVDF	FKM	IP65	549,78
F3.00.H.19	L1	PVDF	EPDM	IP65	713,55
F3.00.H.20	L1	PVDF	FKM	IP65	713,55
F3.00.H.21	L0	INOX 316	EPDM	IP65	769,40
F3.00.H.22	L0	INOX 316	FKM	IP65	769,40
F3.00.H.23	L1	INOX 316	EPDM	IP65	807,75
F3.00.H.24	L1	INOX 316	FKM	IP65	807,75

Marcados en amarillo los modelos estándar

F3.00.C.XX

Ref.	Longitud sensor	Material sensor	Juntas	Protección	€
F3.00.C.01	L0	C-PVC	EPDM	IP68	410,86
F3.00.C.02	L0	C-PVC	FKM	IP68	410,86
F3.00.C.03	L1	C-PVC	EPDM	IP68	431,35
F3.00.C.04	L1	C-PVC	FKM	IP68	431,35
F3.00.C.05	L0	PVDF	EPDM	IP68	549,78
F3.00.C.06	L0	PVDF	FKM	IP68	549,78
F3.00.C.07	L1	PVDF	EPDM	IP68	713,55
F3.00.C.08	L1	PVDF	FKM	IP68	713,55
F3.00.C.09	L0	INOX 316	EPDM	IP68	769,40
F3.00.C.10	L0	INOX 316	FKM	IP68	769,40
F3.00.C.11	L1	INOX 316	EPDM	IP68	807,75
F3.00.C.12	L1	INOX 316	FKM	IP68	807,75

Sensor de caudal de paletas version remota

Alimentación 3-5 VDC. **VERSIÓN COIL.**

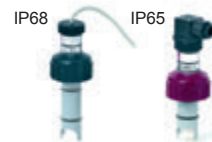

Ref.	Longitud sensor	Material sensor	Juntas	Protección	€
F3.00.C.13	L0	C-PVC	EPDM	IP65	410,86
F3.00.C.14	L0	C-PVC	FKM	IP65	410,86
F3.00.C.15	L1	PVDF	EPDM	IP65	431,35
F3.00.C.16	L1	PVDF	FKM	IP65	431,35
F3.00.C.17	L0	PVDF	EPDM	IP65	549,78
F3.00.C.18	L0	PVDF	FKM	IP65	549,78
F3.00.C.19	L1	PVDF	EPDM	IP65	713,55
F3.00.C.20	L1	PVDF	FKM	IP65	713,55
F3.00.C.21	L0	INOX 316	EPDM	IP65	769,40
F3.00.C.22	L0	INOX 316	FKM	IP65	769,40
F3.00.C.23	L1	INOX 316	EPDM	IP65	807,75
F3.00.C.24	L1	INOX 316	FKM	IP65	807,75

Longitud L0 para diámetros de ø 20-110 mm. Longitud L1 para diámetros de 125-450 mm.

El pedido estándar se compone de sensor + pantalla + accesorios de conexión al tubo. Disponemos de instrucciones de funcionamiento de los modelos.

F3.00.P.XX

R

Ref.	Longitud sensor	Material sensor	Juntas	Protección	€
F3.00.P.01	L0	C-PVC	EPDM	IP68	431,35
F3.00.P.02	L0	C-PVC	FKM	IP68	431,35
F3.00.P.03	L1	C-PVC	EPDM	IP68	441,58
F3.00.P.04	L1	C-PVC	FKM	IP68	441,58
F3.00.P.05	L0	PVDF	EPDM	IP68	574,62
F3.00.P.06	L0	PVDF	FKM	IP68	574,62
F3.00.P.07	L1	PVDF	EPDM	IP68	728,16
F3.00.P.08	L1	PVDF	FKM	IP68	728,16
F3.00.P.09	L0	INOX 316	EPDM	IP68	779,34
F3.00.P.10	L0	INOX 316	FKM	IP68	779,34
F3.00.P.11	L1	INOX 316	EPDM	IP68	819,10
F3.00.P.12	L1	INOX 316	FKM	IP68	819,10

Sensor de caudal de paletas version remota

Alimentación 12-24 VDC. [Para conexión directa a PLC.](#)

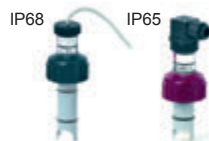

R

Ref.	Longitud sensor	Material sensor	Juntas	Protección	€
F3.00.P.13	L0	C-PVC	EPDM	IP65	431,35
F3.00.P.14	L0	C-PVC	FKM	IP65	431,35
F3.00.P.15	L1	PVDF	EPDM	IP65	441,58
F3.00.P.16	L1	PVDF	FKM	IP65	441,58
F3.00.P.17	L0	PVDF	EPDM	IP65	574,62
F3.00.P.18	L0	PVDF	FKM	IP65	574,62
F3.00.P.19	L1	PVDF	EPDM	IP65	728,16
F3.00.P.20	L1	PVDF	FKM	IP65	728,16
F3.00.P.21	L0	INOX 316	EPDM	IP65	779,34
F3.00.P.22	L0	INOX 316	FKM	IP65	779,34
F3.00.P.23	L1	INOX 316	EPDM	IP65	819,10
F3.00.P.24	L1	INOX 316	FKM	IP65	819,10

Sensor de caudal de paletas version remota

Alimentación 12-24 VDC. [Para conexión directa a PLC.](#)

F3.01.H.XX

R

Ref.	Longitud sensor	Material sensor	Juntas	Protección	€
F3.00.C.01	L0	C-PVC	EPDM	IP68	331,91
F3.00.C.02	L0	C-PVC	FKM	IP68	331,91
F3.00.C.03	L1	C-PVC	EPDM	IP68	349,47
F3.00.C.04	L1	C-PVC	FKM	IP68	349,47
F3.00.C.05	L0	PVDF	EPDM	IP68	448,87
F3.00.C.06	L0	PVDF	FKM	IP68	448,87
F3.00.C.07	L1	PVDF	EPDM	IP68	631,68
F3.00.C.08	L1	PVDF	FKM	IP68	631,68
F3.00.C.09	L0	INOX 316	EPDM	IP68	618,94
F3.00.C.10	L0	INOX 316	FKM	IP68	618,94
F3.00.C.11	L1	INOX 316	EPDM	IP68	650,18
F3.00.C.12	L1	INOX 316	FKM	IP68	650,18

Sensor de caudal de paletas version remota versión compacta.

Alimentación 5-24 VDC. [VERSIÓN COIL.](#)



F3.01.C.XX

R

Ref.	Longitud sensor	Material sensor	Juntas	Protección	€
F3.00.C.13	L0	C-PVC	EPDM	IP65	331,91
F3.00.C.14	L0	C-PVC	FKM	IP65	331,91
F3.00.C.15	L1	PVDF	EPDM	IP65	349,47
F3.00.C.16	L1	PVDF	FKM	IP65	349,47
F3.00.C.17	L0	PVDF	EPDM	IP65	448,87
F3.00.C.18	L0	PVDF	FKM	IP65	448,87
F3.00.C.19	L1	PVDF	EPDM	IP65	631,68
F3.00.C.20	L1	PVDF	FKM	IP65	631,68
F3.00.C.21	L0	INOX 316	EPDM	IP65	618,94
F3.00.C.22	L0	INOX 316	FKM	IP65	618,94
F3.00.C.23	L1	INOX 316	EPDM	IP65	650,18
F3.00.C.24	L1	INOX 316	FKM	IP65	650,18

Sensor de caudal de paletas version remota versión compacta.

Alimentación 3-5 VDC. [VERSIÓN COIL.](#)



Longitud L0 para diámetros de ø 20-110 mm. Longitud L1 para diámetros de 125-450 mm.

El pedido estándar se compone de sensor + pantalla + accesorios de conexión al tubo. Disponemos de instrucciones de funcionamiento de los modelos.



F3.20.X.01

R

Ref.	Longitud sensor	Material sensor	Versión	Protección	€
F3.20.H.01	107	INOX 316	HALL	IP68	645,03
F3.20.P.01	107	INOX 316	Directo a PLC	IP68	677,29

Sensor de caudal de paletas para
ALTAS PRESIONES Y TEMPERATURAS.



F3.10.H.XX

R

Ref.	Longitud sensor	Material sensor	Juntas	Protección	€
F3.10.H.01	41	ABS	EPDM	IP65	169,59
F3.10.P.01	41	ABS	FKM	IP65	169,59

Minisensor de caudal de paletas
 Alimentación 5-24 VDC. **VERSIÓN HALL.**



F6.30

R

Ref.	Longitud sensor	Material sensor	Juntas	Protección	€
F6.30.01	L0	C-PVC	EPDM	IP65	1.080,78
F6.30.02	L0	C-PVC	FKM	IP65	1.080,78
F6.30.03	L1	C-PVC	EPDM	IP65	1.105,76
F6.30.04	L1	C-PVC	FKM	IP65	1.105,76
F6.30.05	L0	PVDF	EPDM	IP65	1.247,37
F6.30.06	L0	PVDF	FKM	IP65	1.247,37
F6.30.07	L1	PVDF	EPDM	IP65	1.507,66
F6.30.08	L1	PVDF	FKM	IP65	1.507,66
F6.30.09	L0	INOX 316	EPDM	IP65	1.516,02
F6.30.10	L0	INOX 316	FKM	IP65	1.516,02
F6.30.11	L1	INOX 316	EPDM	IP65	1.561,81
F6.30.12	L1	INOX 316	FKM	IP65	1.561,81

Transmisor de caudal de paletas **CON SALIDA 4-20 mA.**
 Alimentación 5-24 VDC. **VERSIÓN COIL.**
 Rango caudal: 0,15 - 8 m/s.



F3.05.XX

R

Ref.	Longitud sensor	Material sensor	Juntas	Protección	€
F3.05.01	L0	C-PVC	EPDM	IP65	369,10
F3.05.02	L0	C-PVC	FKM	IP65	369,10
F3.05.03	L1	PVDF	EPDM	IP65	391,81
F3.05.04	L1	PVDF	FKM	IP65	391,81
F3.05.05	L0	PVDF	EPDM	IP65	576,37
F3.05.06	L0	PVDF	FKM	IP65	576,37
F3.05.07	L1	PVDF	EPDM	IP65	611,84
F3.05.08	L1	PVDF	FKM	IP65	611,84
F3.05.09	L0	INOX 316	EPDM	IP65	699,86
F3.05.10	L0	INOX 316	FKM	IP65	699,86
F3.05.11	L1	INOX 316	EPDM	IP65	735,37
F3.05.12	L1	INOX 316	FKM	IP65	735,37

Sensor de caudal de paletas
INTERRUPTOR DE CAUDAL. BATCH CONTROLLER.
 Transmite una se al de apertura al detectar ausencia de caudal.

Longitud L0 para diámetros de ø 20-110 mm. Longitud L1 para diámetros de 125-450 mm.

El pedido estándar se compone de sensor + pantalla + accesorios de conexión al tubo. Disponemos de instrucciones de funcionamiento de los modelos.



F6.60

R

Ref.	Longitud sensor	Material sensor	Juntas	Protección	€
F6.60.09	L0	INOX 316L/PVDF	EPDM	IP65	1.719,50
F6.60.10	L0	INOX 316L/PVDF	FKM	IP65	1.719,50
F6.60.11	L1	INOX 316L/PVDF	EPDM	IP65	1.765,51
F6.60.12	L1	INOX 316L/PVDF	FKM	IP65	1.765,51
F6.60.33	L0	CuNi/PVDF	EPDM	IP65	1.880,52
F6.60.34	L0	CuNi/PVDF	FKM	IP65	1.880,52
F6.60.35	L1	CuNi/PVDF	EPDM	IP65	1.926,51
F6.60.36	L1	CuNi/PVDF	FKM	IP65	1.926,51
F6.60.38	L0	INOX 316/PEEK	FKM	IP65	1.880,52
F6.60.40	L1	INOX 316/PEEK	FKM	IP65	1.926,51

Sensor de caudal electromagnetico **BIDIRECCIONAL**.

Alimentación 12-24 VDC. **VERSIÓN CIEGA**. Rango caudal: 0,15 - 8 m/s.



F6.63

R

Ref.	Longitud sensor	Material sensor	Juntas	Protección	€
F6.63.09	L0	INOX 316L/PVDF	EPDM	IP65	1.461,76
F6.63.10	L0	INOX 316L/PVDF	FKM	IP65	1.461,76
F6.63.11	L1	INOX 316L/PVDF	EPDM	IP65	1.500,85
F6.63.12	L1	INOX 316L/PVDF	FKM	IP65	1.500,85
F6.63.33	L0	CuNi/PVDF	EPDM	IP65	1.598,62
F6.63.34	L0	CuNi/PVDF	FKM	IP65	1.598,62
F6.63.35	L1	CuNi/PVDF	EPDM	IP65	1.637,73
F6.63.36	L1	CuNi/PVDF	FKM	IP65	1.637,73
F6.63.38	L0	INOX 316/PEEK	EPDM	IP65	1.598,62
F6.63.40	L1	INOX 316/PEEK	FKM	IP65	1.637,73

Sensor de caudal electromagnetico **MONODIRECCIONAL**.

Alimentación 12-24 VDC. **VERSIÓN CIEGA**. Rango caudal: 0,15 - 8 m/s.



F6.61.01

R

Ref.	Material cuerpo	Protección	Longitud mm..	€
F6.61.01	INOX 304/PVDF/INOX 316L	EPDM	IP65	3.705,14

Sensor de caudal electromagn tico para tomas en carga.

Alimentación 12-24 VDC. **VERSIÓN HOT TAP**.

Rango caudal: 0,15 - 8 m/s.



F3.8X.H.OX

R

Ref.	Caudal	Material	Engranajes	Juntas	€
F3.81.H.01	10-100 l/h	PP	ECTFE	FKM	767,36
F3.81.H.02	10-100 l/h	ECTFE	ECTFE	FKM	1.129,11
F3.81.H.03	10-100 l/h	INOX 316 L	ECTFE	FKM	1.439,17
F3.82.H.01	25-150 l/h	PP	ECTFE	FKM	767,36
F3.82.H.02	25-150 l/h	ECTFE	ECTFE	FKM	1.129,11
F3.82.H.03	25-150 l/h	INOX 316 L	ECTFE	FKM	1.439,17

Sensor oval para caudales bajos.

Version especial con salida

Alimentación 12-24 VDC. *Protección IP65.*

4-20mA bajo pedido



ULF01.X.X

R

Ref.	Voltaje	Versión	Material	€
ULF01.H.0	5-24 VDC	HALL	POM-FKM	263,56
ULF01.H.2	5-24 VDC	HALL	ECTFE-FKM	651,10
ULF01.H.3	5-24 VDC	HALL	ECTFE-KALREZ	1.018,01
ULF01.R.0	-	REED	POM-FKM	286,80
ULF01.R.2	-	REED	ECTFE-FKM	612,36
ULF01.R.3	-	REED	ECTFE-KALREZ	958,58

Sensor para caudales bajos entre 1,5-100 l/h. *Protección IP65.*



ULF03.X.X

R

Ref.	Voltaje	Versión	Material	€
ULF03.H.0	5-24 VDC	HALL	POM-FKM	263,56
ULF03.H.2	5-24 VDC	HALL	ECTFE-FKM	651,10
ULF03.H.3	5-24 VDC	HALL	ECTFE-KALREZ	1.018,01
ULF03.R.0	-	REED	POM-FKM	286,80
ULF03.R.2	-	REED	ECTFE-FKM	612,36
ULF03.R.3	-	REED	ECTFE-KALREZ	958,58

Sensor para caudales bajos entre 6-250 l/h. *Protección IP65.*

Longitud L0 para diámetros de ø 20-110 mm. Longitud L1 para diámetros de 125-450 mm.

El pedido estándar se compone de sensor + pantalla + accesorios de conexión al tubo. Disponemos de instrucciones de funcionamiento de los modelos.



INDUSTRIA

Medición Electrodos de pH y ORP



pH200/ORP200



Ref.	Descripción	Cable (venta aparte)	Salidas	Instalación	R €
PH200C	Electrodo combinado pH/referencia	No necesario	5 metros cable	EG50P, EG75P, MK150200, MIFV20X05, MIMC20X05	217,60
PH222CD	Electrodo combinado pH/referencia doble toma tipo cartucho	CN653, CN653TC1	Twist-Lock (BNC)	EG50P, EG75P, MIFV20X05, MIMC20X05	269,07
PH223CD	Electrodo combinado pH/referencia doble toma tipo cartucho para accesorios FLS	CN653	Twist-Lock (BNC)	F3.SP2.4	311,17
PH222CDTC	Electrodo combinado pH/referencia doble toma tipo cartucho con Pt 1000	CN653	Twist-Lock (BNC)	F3.SP2.4	692,99
ORP200C	Electrodo combinado ORP/referencia	No necesario	5 metros cable	EG50P, EG75P, MK150200, MIFV20X05, MIMC20X05	292,46
ORP222CD	Electrodo combinado ORP/referencia doble toma tipo cartucho	CN653	Twist-Lock (BNC)	EG50P, EG75P, MIFV20X05, MIMC20X05	422,59
ORP223CD	Electrodo combinado de ORP/referencia doble toma tipo cartucho para accesorios FLS	CN653	Twist-Lock (BNC)	F3.SP2.4	466,85

Electrodo de pH / Electrodo de ORP.

Rango de funcionamiento: 0-14 pH / Rango de funcionamiento: ± 2000 Mv.

Cuerpo epóxico



pH400/ORP400

Ref.	Descripción	Cable (venta aparte)	Salidas	Instalación	R €
PH431CD	Electrodo combinado de pH/referencia doble toma	No necesario	S7	GEG135	701,99
PH435CD	Electrodo combinado de pH/referencia doble toma para altas temperaturas	CE5S7	S7	GEG135, EG135SE	855,66
ORP431CD	Electrodo combinado de ORP/referencia de doble toma	No necesario	S7	GEG135	784,45

Electrodo de pH / Electrodo de ORP.

Rango de funcionamiento: 0-14 pH / Rango de funcionamiento: ± 1000 Mv.

Cuerpo de cristal.

ORP600/pH600



R

Ref.	Descripción	Cable (venta aparte)	Conexión	Instalación	€
ORP660CD	Electrodo de superficie plana combinado de ORP con doble toma de C-PVC	CN653	Twist-Lock (BNC)	EG66P, MK660	727,65
ORP650CD	Electrodo de superficie plana combinado de ORP con doble toma de C-PVC	CN653 / CN653 TC1	Twist-Lock (BNC)	MIFV20X05, MIMC20X05	727,65
ORP655CD	Electrodo de superficie plana combinado de ORP con doble toma de C-PVC y gel de relleno presurizado	CN653	Twist-Lock (BNC)	WT675, WT675 TC1	763,90
ORP660CDDA	Electrodo combinado de pH/ORP de superficie plana con interrupción de bucle de tierra. Aplicaciones: presencia de corrientes parásitas	CN653	Twist-Lock (BNC)	EG66P, MK660	1.380,43
ORP650CDDA	Electrodo combinado de pH/ORP de superficie plana con interrupción de bucle de tierra. Aplicaciones: presencia de corrientes parásitas	CN653 / CN653 TC1	Twist-Lock (BNC)	MIFV20X05, MIMC20X05	1.339,90
PH660CD	Electrodo de pH superficie plana combinado doble toma de C-PVC	CN653	Twist-Lock (BNC)	EG66P, MK660	612,99
PH650CD	Electrodo de pH superficie plana combinado doble toma de C-PVC	CN653 / CN653 TC1	Twist-Lock (BNC)	MIFV20X05, MIMC20X05	612,99
PH655CD	Electrodo de pH superficie plana combinado, doble toma de C-PVC y con gel de relleno presurizado	CN653	Twist-Lock (BNC)	WT675, WT675 TC1	643,40
PH660CDHF	Electrodo de pH superficie plana combinado doble toma de C-PVC. Líquidos con HF (máx. 2%)	CN653	Twist-Lock (BNC)	EG66P, MK660	749,88
PH650CDHF	Electrodo de pH superficie plana combinado doble toma de C-PVC. Líquidos con HF (máx. 2%)	CN653 / CN653 TC1	Twist-Lock (BNC)	MIFV20X05, MIMC20X05	890,26
PH655CDHF	Electrodo de pH superficie plana combinado, doble toma de C-PVC y con gel de relleno presurizado. Líquidos con HF (máx. 2%)	CN653	Twist-Lock (BNC)	WT675, WT675 TC1	890,26
PH660CDDA	Electrodo combinado de pH de superficie plana con interrupción de bucle de tierra. Aplicaciones: presencia de corrientes parásitas	CN653	Twist-Lock (BNC)	EG66P, MK660	1.172,17
PH650CDDA	Electrodo combinado de pH de superficie plana con interrupción de bucle de tierra. Aplicaciones: presencia de corrientes parásitas	CN653 / CN653 TC1	Twist-Lock (BNC)	MIFV20X05, MIMC20X05	1.172,17
PH660CDLC	Electrodo de pH con superficie plana combinado y doble toma de C-PVC. Líquidos con baja conductividad (<100 ms)	CN653	Twist-Lock (BNC)	EG66P, MK660	662,12
PH650CDLC	Electrodo de pH con superficie plana combinado y doble toma de C-PVC. Líquidos con baja conductividad (<100 ms)	CN653 / CN653 TC1	Twist-Lock (BNC)	MIFV20X05, MIMC20X05	780,31
PH655CDLC	Electrodo de pH con superficie plana combinado, doble toma de C-PVC y con gel de relleno presurizado. Líquidos con baja conductividad (<100 ms)	CN653	Twist-Lock (BNC)	WT675, WT675 TC1	780,31

Electrodo de ORP / Electrodo de PH.

De superficie plana.

pH800

R

Ref.	Descripción	Aplicación / Rango operativo	Conexión	Instalación	€
PH870CDTC	Electrodo pH Ryton doble unión con Pt1000	0-14 pH (0-12,3 pH sin Na + error)	5 metros	¾" NPT	1.000,45
PH870CDTCHM	Electrodo pH Ryton doble unión con Pt1000	0-14 pH (0-12,3 pH sin Na + error) Montaje horizontal	5 metros	¾" NPT	1.086,99
PH870CDTCLC	Electrodo pH Ryton doble unión con Pt1000	0-14 pH (0-12,3 pH sin Na + error) Baja conductividad (<100 µS)	5 metros	¾" NPT	1.065,34
PH870CDTCHF	Electrodo pH Ryton doble unión con Pt1000	0-14 pH (0-12,3 pH sin Na + error) Presencia de HF (máx 2%)	5 metros	¾" NPT	1.130,26

Electrodo de PH.

De superficie plana.



INDUSTRIA

Medición

Sensores y transmisores de conductividad



C150/C200

Ref.	Descripción	Rango funcionamiento	Constante de celda	Conexión	Instalación	R
						€
C150.01TC	Sensor de conductividad en grafito con sensor de temperatura	0,1 µS a 2.000 µS	0,1 Cell	5 metros	EG50P, EG75P, MIFV20X05, MIMC20X05	410,25
C150.1TC	Sensor de conductividad en grafito con sensor de temperatura	1µS a 20.000 µS	1,0 Cell	5 metros	EG50P, EG75P, MIFV20X05, MIMC20X05, MK150200	410,25
C200.01TC	Sensor de conductividad en grafito con sensor de temperatura	0,1 µS a 2.000 µS	0,1 Cell	5 metros	EG50P, EG75P, MIFV20X05, MIMC20X05	524,73
C200.1TC	Sensor de conductividad en grafito con sensor de temperatura	1 µS a 20.000 µS	1,0 Cell	5 metros	EG50P, EG75P, MIFV20X05, MIMC20X05	524,73
C200.10TC	Sensor de conductividad en grafito con sensor de temperatura	10 µS a 200.000 µS	10,0 Cell	5 metros	EG50P, EG75P, MIFV20X05, MIMC20X05	524,73

Sensor de conductividad.

De cuerpo epóxico.



C6.30

Ref.	Descripción	Rango funcionamiento	Conexión	Instalación	R
					€
C6.30.01	Transmisor de conductividad inductivo con sensor de temperatura incluido	0-10 mS	3 metros	Rosca macho 1 ½" NPT	1.743,05
C6.30.02	Transmisor de conductividad inductivo con sensor de temperatura incluido	0-100 mS	3 metros	Rosca macho 1 ½" NPT	1.743,05
C6.30.03	Transmisor de conductividad inductivo con sensor de temperatura incluido	0-1.000 mS	3 metros	Rosca macho 1 ½" NPT	1.743,05

Transmisor de conductividad inductivo

Cuerpo en C-PVC.



C100/C300

Ref.	Descripción	Rango funcionamiento	Constante de celda	Conexión	Instalación	R
						€
C100.01TC	Sensor de PP con electrodo de conductividad en acero inox con sensor de temperatura	0,1 µS a 2.000 µS	0,1 Cell	Conector 4 clavijas	Rosca macho 3/4" BSP	367,31
C100.02TC	Sensor de PP con electrodo de conductividad en acero inox con sensor de temperatura	0,2 µS a 4.000 µS	0,2 Cell	Conector 4 clavijas	Rosca macho 3/4" BSP	367,31
C100.1TC	Sensor de PP con electrodo de conductividad en acero inox con sensor de temperatura	1 µS a 20.000 µS	1,0 Cell	Conector 4 clavija	Rosca macho 3/4" BSP	367,31
C300.001TC	Sensor con cuerpo y electrodos de conductividad en acero inox.	0,055 µS a 200 µS	0,01 Cell	3 metros	EG12 SS	727,44
C300.001TCCK	Sensor con cuerpo y electrodo de conductividad en acero inox. con certificado de constante de Cell	0,055 µS a 200 µS	0,01 Cell	3 metros	EG12 SS	926,89
C300.10TC	Sensor con cuerpo y electrodos de conductividad en acero inox.	10 µS a 200.000 µS	10,0 Cell	3 metros	EG12 SS	727,44

Sensor de conductividad.

C100 cuerpo en PP y C300 cuerpo en inox.



						R
d x Rh	Ref.	DN	Material	Longitud sensor	Juntas	€
20	TFIV20B	15	PVC-U	L0	EPDM	106,04
25	TFIV25B	20	PVC-U	L0	EPDM	106,04
32	TFIV32B	25	PVC-U	L0	EPDM	133,27
40	TFIV40B	32	PVC-U	L0	EPDM	133,27
50	TFIV50B	40	PVC-U	L0	EPDM	148,44
20	TFIV20D	15	PVC-U	L0	FKM	106,04
25	TFIV25D	20	PVC-U	L0	FKM	106,04
32	TFIV32D	25	PVC-U	L0	FKM	133,27
40	TFIV40D	32	PVC-U	L0	FKM	133,27
50	TFIV50D	40	PVC-U	L0	FKM	148,44
20	TFIM20B	15	PP-H	L0	EPDM	122,70
25	TFIM25B	20	PP-H	L0	EPDM	122,70
32	TFIM32B	25	PP-H	L0	EPDM	157,52
40	TFIM40B	32	PP-H	L0	EPDM	157,52
50	TFIM50B	40	PP-H	L0	EPDM	180,25
20	TFIM20D	15	PP-H	L0	FKM	122,70
25	TFIM25D	20	PP-H	L0	FKM	122,70
32	TFIM32D	25	PP-H	L0	FKM	157,52
40	TFIM40D	32	PP-H	L0	FKM	157,52
50	TFIM50D	40	PP-H	L0	FKM	180,25

Te

Otras conexiones disponibles bajo pedido



					R
Ref.	Material	Juntas			€
HF6004	0-400 mbarg	PVDF, PUR, FKM cerámica			1.384,56
HF6010	0-1.000 mbarg	PVDF, PUR, FKM cerámica			1.384,56
HF6100	0-10 barg	PVDF, PUR, FKM cerámica			1.384,56
HF6160	0-16 barg	PVDF, PUR, FKM cerámica			1.384,56

Transmisor de presión y nivel de profundidad..

						R
d x Rh	Ref.	DN	Material	Longitud sensor	Juntas	€
20	TFIF20B	15	PVDF	L0	EPDM	198,42
25	TFIF25B	20	PVDF	L0	EPDM	198,42
32	TFIF32B	25	PVDF	L0	EPDM	212,07
40	TFIF40B	32	PVDF	L0	EPDM	212,07
50	TFIF50B	40	PVDF	L0	EPDM	239,32
20	TFIF20D	15	PVDF	L0	FKM	198,42
25	TFIF25D	20	PVDF	L0	FKM	198,42
32	TFIF32D	25	PVDF	L0	FKM	212,07
40	TFIF40D	32	PVDF	L0	FKM	212,07
50	TFIF50D	40	PVDF	L0	FKM	239,32
20	TFIV20BE	15	PVC-U+PE	L0	EPDM	106,04
25	TFIV25BE	20	PVC-U+PE	L0	EPDM	106,04
32	TFIV32BE	25	PVC-U+PE	L0	EPDM	133,27
40	TFIV40BE	32	PVC-U+PE	L0	EPDM	133,27
50	TFIV50BE	40	PVC-U+PE	L0	EPDM	148,44
20	TFIV20DE	15	PVC-U+PE	L0	FKM	106,04
25	TFIV25DE	20	PVC-U+PE	L0	FKM	106,04
32	TFIV32DE	25	PVC-U+PE	L0	FKM	133,27
40	TFIV40DE	32	PVC-U+PE	L0	FKM	133,27
50	TFIV50DE	40	PVC-U+PE	L0	FKM	148,44
½"	TFFX20	15	INOX316	L0		305,97
¾"	TFFX25	20	INOX316	L0		305,97
1"	TFFX32	25	INOX316	L0		305,97
1¼"	TFFX4	32	INOX316	L0		331,72



INDUSTRIA

Medición

Accesorios de instalación



d	Ref.	DN	Material	Longitud sensor	R
					€
50-225	WAIXL0	40-200	Inox 316L	L0	163,60
250-600	WAIXL1	225-600	Inox 316L	L1	184,77

Inserto para tubos metálicos.



Ref.	Descripción	R
		€
WAIXHP	Kit inserto adaptación Inox 316 para F3.20.X.01	385,31

Accesorio de instalación.

para sensor **F3.20.X.01**.

De Ø 50 a Ø 225 (DN40 A DN200).



Ref.	Cuerpo	DN	R
			€
WAIXHT	Inox 316L	350-400	163,60

Adaptador para toma en carga para sensores.

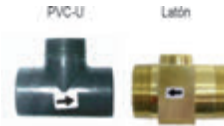

d	Ref.	DN	Cuerpo	Conexion	R
					€
20	TMIV20MF	15	PVC-U	H encolar	57,56
25	TMIV25MF	20	PVC-U	H encolar	60,57
32	TMIV32MF	25	PVC-U	H encolar	60,57
40	TMIV40MF	32	PVC-U	H encolar	63,62
50	TMIV50MF	40	PVC-U	H encolar	63,62
1¼"	TMFODN23	23	Latón	M roscar	246,90

Te. para minisensor **F3.10.H.XX**.



d	Ref.	DN	Cuerpo	Longitud sensor	Juntas	R
						€
63	SVIC063BVC	50	PVC-U	L0	EPDM	119,94
75	SVIC075BVC	65	PVC-U	L0	EPDM	158,13
90	SVIC090BVC	80	PVC-U	L0	EPDM	158,13
110	SVIC110BVC	100	PVC-U	L0	EPDM	171,75
125	SVIC125BVC	110	PVC-U	L1	EPDM	182,68
140	SVIC140BVC	125	PVC-U	L1	EPDM	190,84
160	SVIC160BVC	150	PVC-U	L1	EPDM	238,56
200	SVIC200BVC	180	PVC-U	L1	EPDM	238,56
225	SVIC225BVC	200	PVC-U	L1	EPDM	248,10
110	SVIC110DVC	100	PVC-U	L0	FKM	171,76
125	SVIC125DVC	110	PVC-U	L1	FKM	182,69
250	SMIC250IVC	225	PP	L0	NBR	309,00
280	SMIC280IVC	250	PP	L1	NBR	345,33
315	SMIC315IVC	300	PP	L1	NBR	345,33

Collarín para tubos de PVC-U y C-PVC.

Inserto en C-PVC.



d	Ref.	DN	Cuerpo	Longitud sensor	Juntas	R
						€
63	SVIC063BME	50	PVC-U	L0	EPDM	119,94
75	SVIC075BME	65	PVC-U	L0	EPDM	158,13
90	SVIC090BME	80	PVC-U	L0	EPDM	158,13
110	SVIC110BME	100	PVC-U	L0	EPDM	171,75
125	SVIC125BME	110	PVC-U	L1	EPDM	182,68
140	SVIC140BME	125	PVC-U	L1	EPDM	190,84
160	SVIC160BME	150	PVC-U	L1	EPDM	238,56
200	SVIC200BME	180	PVC-U	L1	EPDM	238,56
225	SVIC225BME	200	PVC-U	L1	EPDM	248,10
110	SVIC110DME	100	PVC-U	L0	FKM	171,75
125	SVIC125DME	110	PVC-U	L1	FKM	182,69
250	SMIC250IME	225	PP	L0	NBR	309,00
280	SMIC280IME	250	PP	L1	NBR	345,33
315	SMIC315IME	300	PP	L1	NBR	345,33

Collarín para tubos de PP-H y PE.

Inserto en C-PVC.



R

d	Ref.	DN	Cuerpo	Longitud sensor	Juntas	€
63	SVIF063BF	50	PVC-U	L0	EPDM	155,41
75	SVIF075BF	65	PVC-U	L0	EPDM	205,83
90	SVIF090BF	80	PVC-U	L0	EPDM	205,83
110	SVIF110BF	100	PVC-U	L0	EPDM	223,57

Collarín para tubos de PVDF

Inserto en PVDF.



R

Ref.	DN	Cuerpo	Longitud sensor	Tolerancia	€
SZIC080I	80	Acero+inox	L0	88-104	195,42
SZIC100I	100	Acero+inox	L0	112-126	201,45
SZIC125I	125	Acero+inox	L0	140-154	257,49
SZIC150I	150	Acero+inox	L0	168-184	272,62
SZIC200I	200	Acero+inox	L1	218-244	284,77
SZIC250I	250	Acero+inox	L1	272-295	301,40
SZIC300I	300	Acero+inox	L1	322-354	319,58
SZIC350I	350	Acero+inox	L1	356-414	346,85
SZIC400I	400	Acero+inox	L1	406-472	393,82
SZIC450I	450	Acero+inox	L1	457-534	478,64

Collarín metálico.

Junta en NBR. Inserto en C-PVC.



R

d	Ref.	DN	Cuerpo	Longitud sensor	Juntas	€
63	SVIF063DF	50	PVC-U	L0	FKM	155,41
75	SVIF075DF	65	PVC-U	L0	FKM	205,83
90	SVIF090DF	80	PVC-U	L0	FKM	205,83
110	SVIF110DF	100	PVC-U	L0	FKM	223,57

Collarín para tubos de PVDF.

Inserto en PVDF.



R

Ref.	DN	Cuerpo	Longitud sensor	Tolerancia	€
SZIC080IHT	80	Acero+inox	L0	88-104	195,42
SZIC100IHT	100	Acero+inox	L0	112-126	201,45
SZIC125IHT	125	Acero+inox	L0	140-154	257,49
SZIC150IHT	150	Acero+inox	L0	168-184	272,62
SZIC200IHT	200	Acero+inox	L1	218-244	284,77
SZIC250IHT	250	Acero+inox	L1	272-295	301,40
SZIC300IHT	300	Acero+inox	L1	322-354	319,58
SZIC350IHT	350	Acero+inox	L1	356-414	346,85
SZIC400IHT	400	Acero+inox	L1	406-472	393,82
SZIC450IHT	450	Acero+inox	L1	457-534	478,64

Collarín metálico. con toma en carga.

Salida 2" rosca hembra. Junta en NBR.

Longitud L0 para diámetros de ø 20-110 mm. Longitud L1 para diámetros de 125-450 mm.



Adaptadores para instalación en línea, sumergibles e instalación Wet-Tap.

R

	Ref.	Cuerpo	Descripción	Para electrodos	€
	EG12SS	Inox	Prensaestopas de electrodos macho 1/2"	C300	187,77
	TCONIV32E	PVC-U	Accesorio en T ø 32 DN25	C150-200	109,09
	TCONIV40E	PVC-U	Accesorio en T ø 40 DN32	C150-200	114,54
	TCONIV50E	PVC-U	Accesorio en T ø 50 DN40	C150-200	120,28
	TCONIC32E	C-PVC	Accesorio en T ø 32 DN25	C150-200	121,11
	TCONIC40E	C-PVC	Accesorio en T ø 40 DN32	C150-200	127,18
	TCONIC50E	C-PVC	Accesorio en T ø 50 DN40	C150-200	133,53
		TPHIV32E	PVC-U	Accesorio en T ø 32 DN25	PH/ORP200 (NO p/PH223CD,ORP223CD)
TPHIV40E		PVC-U	Accesorio en T ø 40 DN32	PH/ORP200 (NO p/PH223CD,ORP223CD)	85,68
TPHIV50E		PVC-U	Accesorio en T ø 50 DN40	PH/ORP200 (NO p/PH223CD,ORP223CD)	120,27
TPHIC32E		C-PVC	Accesorio en T ø 32 DN25	PH/ORP200 (NO p/PH223CD,ORP223CD)	96,89
TPHIC40E		C-PVC	Accesorio en T ø 40 DN32	PH/ORP200 (NO p/PH223CD,ORP223CD)	101,75
TPHIC50E		C-PVC	Accesorio en T ø 50 DN40	PH/ORP200 (NO p/PH223CD,ORP223CD)	106,81
TPHIC32C		C-PVC	Accesorio en T ø 32 DN25	PH660-ORP660	121,14
TPHIC40C		C-PVC	Accesorio en T ø 40 DN32	PH660-ORP660	125,98
TPHIC50C		C-PVC	Accesorio en T ø 50 DN40	PH660-ORP660	131,05
		EG66P	C-PVC	Prensaestopas de electrodos macho 3/4"	PH660-ORP660
	MK660	C-PVC	Kit de instalación (adaptador + tapón amarillo) para accesorios FLS hasta DN100 (4")	PH660-ORP660	35,79
	MK150200	C-PVC	Kit de instalación (EG50P + adaptador + tapón amarillo) para accesorios FLS hasta DN100 (4")	PH200C, ORP200C, C150.1, C150.01TC	75,54
	GEG135SE	PP	Prensaestopas para electrodo PG13.5 con protección de cabeza de electrodo 1/4" G.M.	PH430CD, ORP430CD, PH435CD	291,55
	F3.SP2.4	PVC-U	Tapón de electrodo color amarillo para accesorios FLS hasta DN100 (4")	PH223CD, ORP223CD	23,43
	GEG135	PVC-U	Prensaestopas para electrodo PG13.5 o cuerpo de 12 mm y 1/2" G.M.	PH-ORP400	27,84
	EG50P	PP	Prensaestopas de electrodo macho 1/2"	PH-ORP200 (NO para PH223CD, ORP223CD), C150-200, T970278, T970196	37,78
	EG75P	PP	Prensaestopas de electrodo macho 3/4"	PH-ORP200 (NO para PH223CD, ORP223CD), 0-200, T970278, T970196	37,78
	EG135FS	PVDF / FKM	Prensaestopas corto p/electrodo PG13.5 1/2"	PH-ORP430, PH435CD	76,57
	EG135FL	PVDF / FKM	Prensaestopas largo p/electrodo PG13.5 1/2"	PH-ORP430, PH435CD	84,19



Adaptadores para instalación en inmersión.

R

	Ref.	Cuerpo	Descripción	Para electrodos	€
	MIFV20X05	PVC-U	Doble toma 20 x 1/2" (tubería suministrada por el cliente)	PH200C-ORP200C (con EG50P), PH222CD ORP222CD (con CN653), (GEG135), PH650 ORP650 (CON CN653), C150-200 (CON EG50P)	4,01
	MIMC20X05	C-PVC	Doble toma 20 x 1/2" (tubería suministrada por el cliente)	PH200C-ORP200C (con EG50P), PH222CD ORP222CD (con CN653), (GEG135), PH650 ORP650 (CON CN653), C150-200 (CON EG50P)	17,89

Adaptadores para toma en carga u horizontal.

R

	Ref.	Cuerpo	Descripción	Para electrodos	€
	WT675	C-PVC	Prensaestopa de electrodo para instalación con toma en carga: inserción máxima 300 mm (12")	PH655-ORP655	851,83
	WT675TC1	C-PVC/SS	Prensaestopa de electrodo para instalación con toma en carga: inserción máxima 300 mm (12")	PH655-ORP655	1.272,05

Recambios para monitor M9.00.

R

Ref.	Descripción	€
M9.SP4.1	Prensaestopas de cable completo PG11 (2 juntas tóricas y capuchón)	8,53
M9.LN1	Tuerca de bloqueo de plástico para M9.02	42,99
M9.SN1	2 Tornillos de fijación de plástico para instalación en panel de todos los monitores FLS (excepto para M9.02)	42,99
M9.SP7	Recambio de batería 3,6 voltios (2,4 Ah). Batería de litio cloruro de tionilo (sólo para M9.20)	149,50
M9.KUSB	Cable USB para productos FLS, 1,5 metros de longitud	22,07

Recambios para sensor de caudal de paletas F3.00.

R

Ref.	Descripción	€
F3.SP1	Enchufe de cable de 4 clavijas según DIN 43650	48,75
F3.SP2.1	Tapón negro para sensor versión HALL	23,43
F3.SP2.2	Tapón rojo para sensor versión COIL	23,43
F3.SP2.4	Tapón amarillo para sensor versión PLC	23,43
F3.SP2.6	Tapón en inox AISI 316 para sensor en inox versión HALL y COIL	52,67
F3.SP3.1	Juntas tóricas para cuerpo del sensor en EPDM	3,94
F3.SP3.2	Juntas tóricas para cuerpo del sensor en FKM	5,87
F3.SP4.2	Kit rotor. Rotor en ECTFE (Halar®) con cojinetes y eje en cerámica mecanizada	196,97
F3.SP4.3	Kit rotor. Rotor en ECTFE (Halar®) con eje en acero inox	120,90
F3.SP5.1	Toma de sensor en C-PVC	54,61
F3.SP5.2	Toma de sensor en PVDF	77,48
F3.SP5.3	Toma de sensor en acero inox	29,24
F3.SP6	Cable eléctrico (precio por metro), 22AWG, 3 cond.	4,37

Recambios para sensor de caudal de paletas para altas presiones F3.20

R

Ref.	Descripción	€
F3.SP4.3	Kit rotor. Rotor en ECTFE (Halar®) con eje en acero inox	120,90
F3.SP8	Kit de juntas y tornillos. Tornillos en acero inox y junta en grafito	50,83

Recambios para transmisor de caudal de paletas F6.30.

R

Ref.	Descripción	€
F6.KC1	Kit de montaje compacto. Adaptador de plástico con capuchón compacto y tuerca de bloqueo	124,92
M9.SP4.1	Prensaestopas de cable completo PG11 (2 juntas tóricas y capuchón)	8,53
F3.SP3.1	Juntas tóricas para cuerpo del sensor en EPDM	3,94
F3.SP3.2	Juntas tóricas para cuerpo del sensor en FKM	5,87
F6.30.SP1.S	Dispositivo electrónico con salida 4-20 mA y salida de impulsos de frecuencia/volumen para sensor de caudal de paletas	1.156,03
M9.KUSB	Cable USB para productos FLS, 1,5 metros de longitud	22,07

Recambios para minisensor de caudal de paletas F3.10.

R

Ref.	Descripción	€
F3.SP2.7	Tapa de sensor gris	9,20
F3.SP3.3	Juntas tóricas para cuerpo del sensor en EPDM	4,01
F3.SP3.4	Juntas tóricas para cuerpo del sensor en FKM	5,94
F3.SP11	Kit rotor. Rotor de PVC con eje en AISI 316L	61,49
M9.KUSB	Cable USB para productos FLS, 1,5 metros de longitud	22,07

Recambios para sensor de caudal de paletas interruptor de caudal (Batch Controller) F3.05.

R

Ref.	Descripción	€
F3.SP1	Enchufe de cable de 4 clavijas según DIN 43650	48,75
F3.SP2.1	Tapón negro para sensor versión HALL	23,43
F3.SP3.1	Juntas tóricas para cuerpo del sensor en EPDM	3,94
F3.SP3.2	Juntas tóricas para cuerpo del sensor en FKM	5,87
F3.SP4.2	Kit rotor. Rotor en ECTFE (Halar®) con cojinetes y eje en cerámica mecanizada	196,97
F3.SP5.1	Toma de sensor en C-PVC	54,61
F3.SP5.2	Toma de sensor en PVDF	77,48
F3.SP5.3	Toma de sensor en acero inox	29,24

Recambios para sensor de caudal electromagnético para tomas en carga F6.61.

R

Ref.	Descripción	€
F6.KC1	Kit de montaje compacto. Adaptador de plástico con capuchón compacto y tuerca de bloqueo	124,92
M9.SP4.1	Prensaestopas de cable completo PG11 (2 juntas tóricas y capuchón)	8,53
F1.SP3	Válvula de aislamiento esférica de latón 2"	155,37
F1.SP5	Válvula de aislamiento esférica de latón 1 1/4"	155,37
F1.SP6	Reducción roscada macho-hembra 2"-1 1/4" en acero cincado	16,35
F1.SP7	Reducción roscada macho(NPT)-hembra 2"-1 1/4" en acero cincado	16,35
F6.60M.SP1.S	Dispositivo electrónico de medición magnética con salida 4-20 mA y salida de impulsos de frecuencia/volumen.	1.156,03
F3.61M.SP01	Sensor de caudal de medidor electromagnético para inserción con toma en carga. Cuerpo en inox 304/PVDF	3.095,77
M9.KUSB	Cable USB para productos FLS, 1,5 metros de longitud	22,07



Recambios para sensor de caudal electromagnético F6.60 R

R

Ref.	Descripción	€
F6.KC1	Kit de montaje compacto. Adaptador de plástico con capuchón compacto y tuerca de bloqueo	124,92
M9.SP4.1	Prensaestopas de cable completo PG11 (2 juntas tóricas y capuchón)	8,53
F3.SP3.1	Juntas tóricas para cuerpo del sensor en EPDM	3,94
F3.SP3.2	Juntas tóricas para cuerpo del sensor en FKM	5,87
F6.60.SP1.S	Dispositivo electrónico de medición magnética con salida 4-20 mA y salida de impulsos de frec./volum. para sensor bidireccional	1.156,03
F3.60M.SP09	Sensor de caudal bidireccional p/medidor electromagn. Cuerpo en inox 316L/PVDF. Juntas tóricas en EPDM. Long. L0	1.046,62
F3.60M.SP10	Sensor de caudal bidireccional p/medidor electromagn. Cuerpo en inox 316L/PVDF. Juntas tóricas en FKM. Long. L0	1.046,49
F3.60M.SP11	Sensor de caudal bidireccional p/medidor electromagn. Cuerpo en inox 316L/PVDF. Juntas tóricas en EPDM. Long. L1	1.115,49
F3.60M.SP12	Sensor de caudal bidireccional p/medidor electromagn. Cuerpo en inox 316L/PVDF. Juntas tóricas en FKM. Long. L1	1.115,49
F3.60M.SP13	Sensor de caudal bidireccional p/medidor electromagn. Cuerpo en CuNi/PVDF. Juntas tóricas en EPDM. Long. L0	1.207,51
F3.60M.SP14	Sensor de caudal bidireccional p/medidor electromagn. Cuerpo en CuNi/PVDF. Juntas tóricas en FKM. Long. L0	1.207,51
F3.60M.SP15	Sensor de caudal bidireccional p/medidor electromagn. Cuerpo en CuNi/PVDF. Juntas tóricas en EPDM. Long. L1	1.276,51
F3.60M.SP16	Sensor de caudal bidireccional p/medidor electromagn. Cuerpo en CuNi/PVDF. Juntas tóricas en FKM. Long. L1	1.276,51
F3.60M.SP17	Sensor de caudal bidireccional p/medidor electromagn. Cuerpo en inox316L/PEEK. Juntas tóricas en FKM. Long. L0	1.207,51
F3.60M.SP18	Sensor de caudal bidireccional p/medidor electromagn. Cuerpo en inox316L/PEEK. Juntas tóricas en FKM. Long. L1	1.276,51
M9.KUSB	Cable USB para productos FLS, 1,5 metros de longitud	22,07

Recambios para monitor M9.00.

R

Ref.	Descripción	€
 F6.KC1	Kit de montaje compacto. Adaptador de plástico con capuchón compacto y tuerca de bloqueo (sólo para monitor M9.02)	124,92
 M9.KW1	Kit de montaje mural. Caja plástica de 144 x 144 mm para instalación mural de todos los monitores de montaje en panel	182,82
M9.KW2	Kit de montaje mural con alimentación. Caja plástica de 144 x 144 mm para instalación mural de todos los monitores de montaje en panel y fuente de alimentación de 110/230 VAC a 24DC incluida	355,45
M9.KUSB	Cable USB para productos FLS 1,5 metros de longitud	22,07

Recambios para electrodos de pH/ORP

R

	Ref.	Descripción	€
	CN653	Montaje cable universal de 5 metros. Para electrodos: PH222CD, OPR222CD, ORP223CD, PH-ORP600	248,01
	CN65310M	Montaje cable universal de 10 metros. Para electrodos: PH222CD, OPR222CD, ORP223CD, PH-ORP600	306,50
	CN65315M	Montaje cable universal de 15 metros. Para electrodos: PH222CD, OPR222CD, ORP223CD, PH-ORP600	364,97
	CN653TC1	Montaje de cable sumergible de 5 metros con compensación de temperatura. Para electrodos PH222CD, PH223CD, PH650CD, PH650CDHF, PH650CDDA, PH650CDLC	694,91
	CE5S7	Montaje cable de 5 metros. Para electrodos: PH435CD, PH430CD, ORP430CD	187,17
	CE10S7	Montaje cable de 10 metros. Para electrodos: PH435CD, PH430CD, ORP430CD	222,28
	CE15S7	Montaje cable de 15 metros. Para electrodos: PH435CD, PH430CD, ORP430CD	257,37
	B104	Solución tampón pH 4,01	63,15
	B107	Solución tampón pH 7,00	63,15
	B110	Solución tampón pH 10,00	63,15
	B3KCL	Solución tampón pH solución 3KCl	75,42
	B475	Solución tampón ORP 475 mV	63,15

Recambios para sensores de conductividad.

R

	Ref.	Descripción	€
	T970278	Sensor de temperatura PT100 con dos cables (5 metros) y cuerpo epóxico **	175,47
	T970196	Sensor de temperatura PT100 con dos cables (5 metros) y cuerpo epóxico ** (sin metal ni contacto)	444,53
	B0018	Solución tampón de conductividad para calibración de baja conductividad (18 microsiemens)	105,29
	B1417	Solución tampón de conductividad para calibración de conductividad (1.417 microsiemens)	105,29

** +5 € / metro cable

Tubo y accesorios
Válvulas manuales
Válvulas actuadas
Válvulas de control de presión

Sistema PP-H Socket

INDUSTRIA



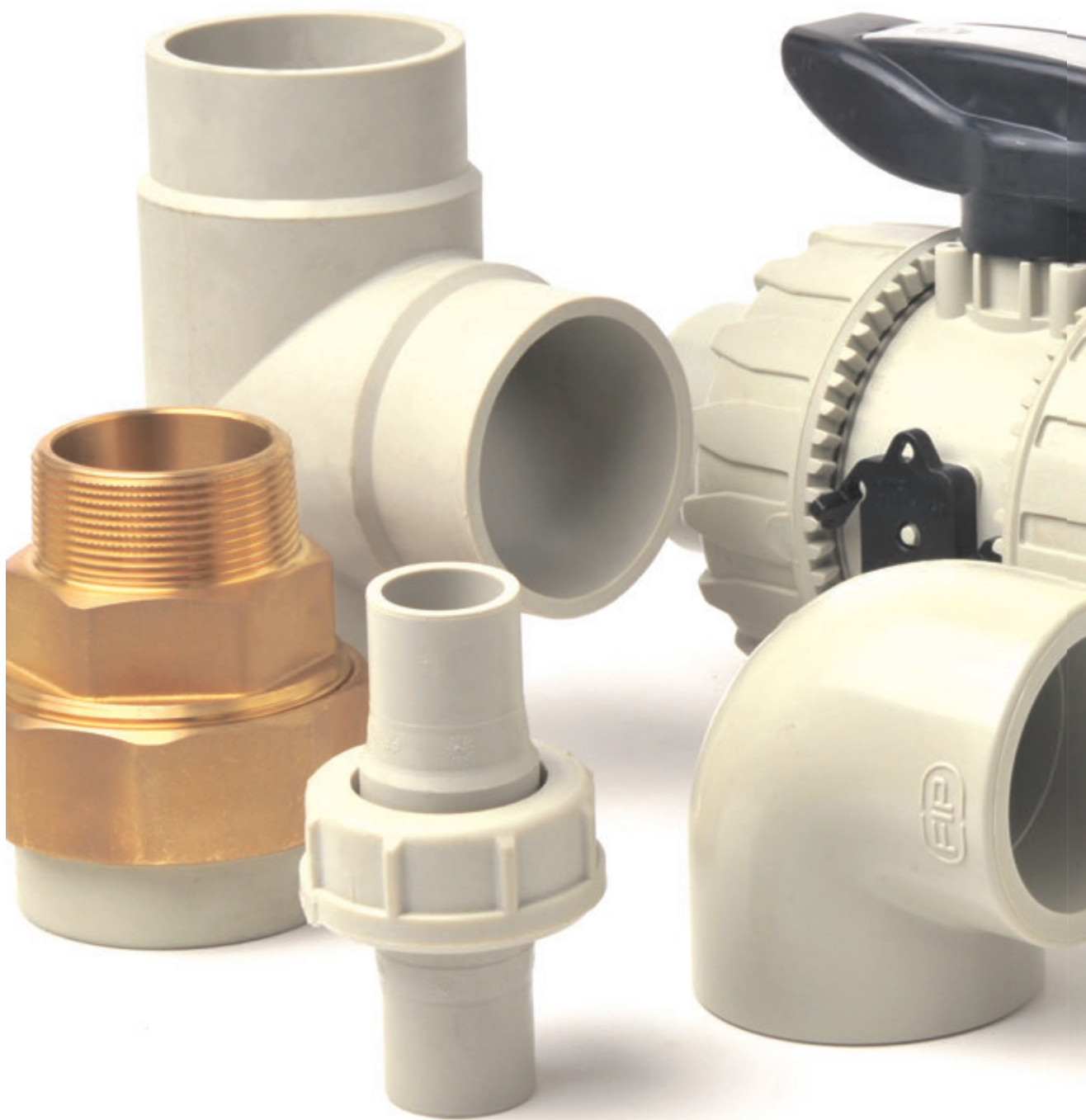

Sistema PP-H Socket

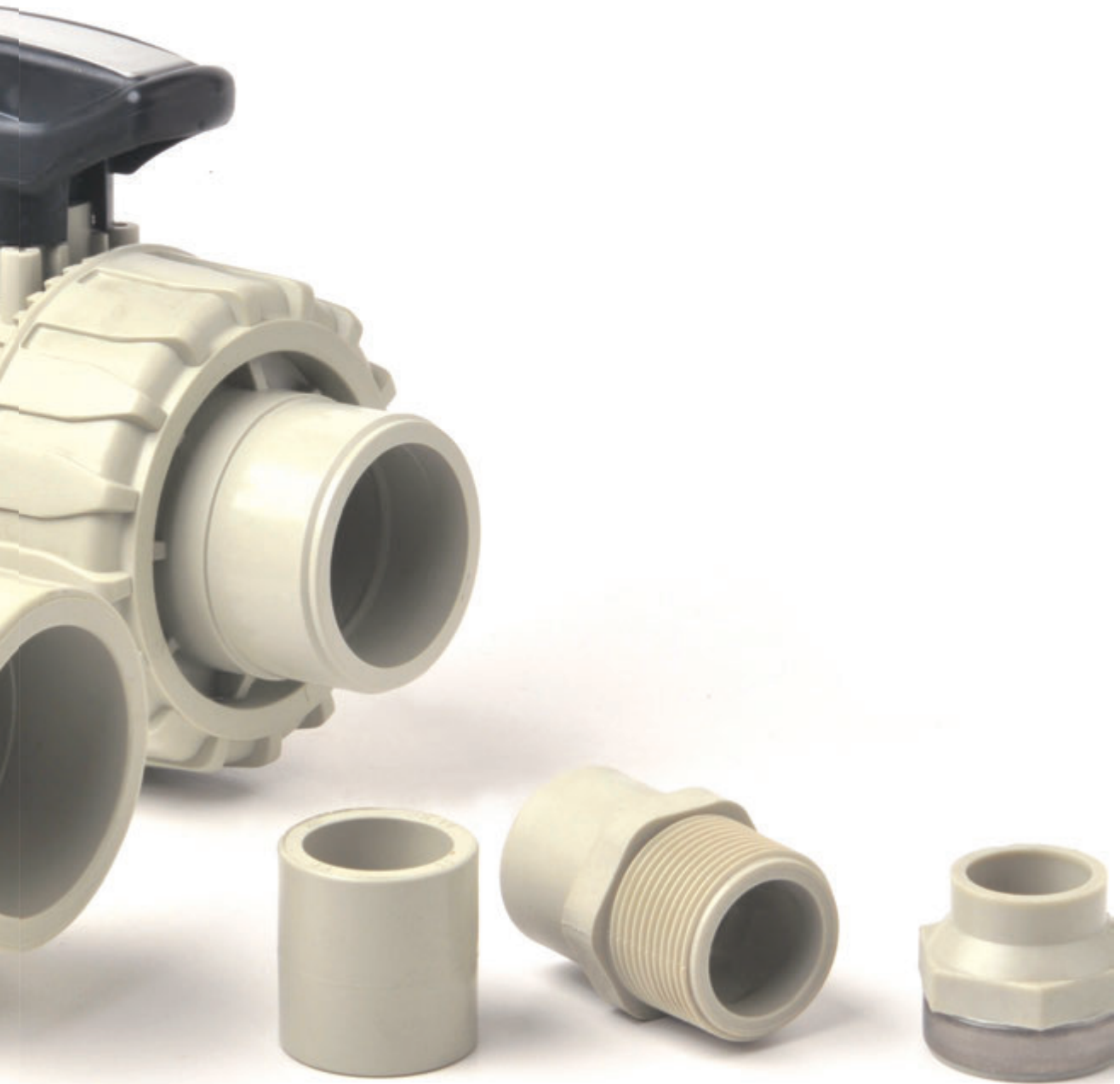



INDUSTRIA

Sistema PP-H Socket

Tubo



T1



T1

d	Ref.	Espesor	Longitud barras	€/m.
25	PIPEM17025	1,8	5 m.	1,73
32	PIPEM17032	1,9	5 m.	2,18
40	PIPEM17040	2,3	5 m.	3,50
50	PIPEM17050	2,9	5 m.	5,30
63	PIPEM17063	3,6	5 m.	8,23
75	PIPEM17075	4,3	5 m.	11,69
90	PIPEM17090	5,1	5 m.	16,62
110	PIPEM17110	6,3	5 m.	24,85
125	PIPEM17125	7,1	5 m.	31,84
140	PIPEM17140	8,0	5 m.	39,96
160	PIPEM17160	9,1	5 m.	52,07
180	PIPEM17180	10,2	5 m.	81,84
200	PIPEM17200	11,4	5 m.	97,75
225	PIPEM17225	12,8	5 m.	127,79
250	PIPEM17250	14,2	5 m.	160,39
280	PIPEM17280	15,9	5 m.	196,64
315	PIPEM17315	17,9	5 m.	249,99
355	PIPEM17355	20,1	5 m.	372,23
355	PIPEM17355	20,1	5 m.	372,23
400	PIPEM17400	22,7	5 m.	469,03
400	PIPEM17400	22,7	5 m.	469,03
450	PIPEM17450	25,5	5 m.	651,78
500	PIPEM17500	28,4	5 m.	806,16
560	PIPEM17560	31,7	5 m.	1.163,36
630	PIPEM17630	35,7	5 m.	1.473,94
710	PIPEM17710	40,2	5 m.	1.869,29
800	PIPEM17800	45,3	5 m.	2.382,57

Tubo PP-H (100) SDR17,6 (PN6).

Para soldar socket y a testa. Para otros diámetros consultar disponibilidad.

d	Ref.	PN	Longitud barras	€/m.
20	PIPEM11020	10	5 m.	1,39
25	PIPEM11025	10	5 m.	2,14
32	PIPEM11032	10	5 m.	3,31
40	PIPEM11040	10	5 m.	5,23
50	PIPEM11050	10	5 m.	7,97
63	PIPEM11063	10	5 m.	12,63
75	PIPEM11075	10	5 m.	17,48
90	PIPEM11090	10	5 m.	25,34
110	PIPEM11110	10	5 m.	37,59
125	PIPEM11125	10	5 m.	48,83
140	PIPEM11140	10	5 m.	60,79
160	PIPEM11160	10	5 m.	79,77
180	PIPEM11180	10	5 m.	125,73
200	PIPEM11200	10	5 m.	152,56
225	PIPEM11225	10	5 m.	193,85
250	PIPEM11250	10	5 m.	246,65
280	PIPEM11280	10	5 m.	297,50
315	PIPEM11315	10	5 m.	383,89
355	PIPEM11355	10	5 m.	582,26
400	PIPEM11400	10	5 m.	734,45
450	PIPEM11450	10	5 m.	1.018,21
500	PIPEM11500	10	5 m.	1.255,95

Tubo PP-H (100) SDR11 (PN10).

Para soldar socket y a testa. Para otros diámetros consultar disponibilidad.

**TIM**

T

d	Ref.	Pack	€
20	TIM020	10	3,98
25	TIM025	10	4,39
32	TIM032	10	5,12
40	TIM040	5	6,58
50	TIM050	5	11,75
63	TIM063	2	15,01
75	TIM075	-	34,80
90	TIM090	-	56,20
110	TIM110	-	71,32

Te a 90°.

H-H para fusión socket.

**GIM**

T

d	Ref.	Pack	€
20	GIM020	10	3,38
25	GIM025	10	3,98
32	GIM032	10	4,81
40	GIM040	5	6,12
50	GIM050	5	11,27
63	GIM063	2	14,64
75	GIM075	-	30,46
90	GIM090	-	37,47
110	GIM110	-	56,20

Codo 90°.

H-H para fusión socket.

**HIM**

T

d	Ref.	Pack	€
20	HIM020	10	4,81
25	HIM025	10	5,12
32	HIM032	10	6,32
40	HIM040	5	8,76
50	HIM050	5	11,27
63	HIM063	2	15,01
75	HIM075	-	34,80
90	HIM090	-	48,03
110	HIM110	-	70,24

Codo 45°.

H-H para fusión socket.

**MIM**

T

d	Ref.	Pack	€
20	MIM020	10	2,32
25	MIM025	10	2,65
32	MIM032	10	3,06
40	MIM040	5	3,68
50	MIM050	5	7,04
63	MIM063	2	10,70
75	MIM075	-	14,89
90	MIM090	-	21,28
110	MIM110	-	33,39

Manguito.

H-H para fusión socket.

MIMM



T

d x Rh	Ref.	Pack	€
20 x 1/2"	MIMM020012	10	4,52
25 x 3/4"	MIMM025034	10	5,74
32 x 1"	MIMM032100	10	7,31
40 x 1 1/4"	MIMM040114	5	8,76
50 x 1 1/2"	MIMM050112	5	14,39
63 x 2"	MIMM063200	2	18,22

Manguito mixto reforzado.
H-H para fusión socket-rosacar.

QRNM



T

d	Ref.	Pack	€
20	QRNM020	10	5,65
25	QRNM025	10	5,89
32	QRNM032	10	6,39
40	QRNM040	5	7,87
50	QRNM050	5	9,20
63	QRNM063	2	11,42
75	QRNM075	-	24,73
90	QRNM090	-	39,05
110	QRNM110	-	54,04

Manguito portabridas estriado.
H para fusión socket.

ODC



B1

d	Ref.	DN	€
20	ODC020	15	5,46
25	ODC025	20	6,50
32	ODC032	25	7,53
40	ODC040	32	9,22
50	ODC050	40	11,91
63	ODC063	50	13,25
75	ODC075	65	19,74
90	ODC090	80	21,81
110	ODC110	100	29,94

Brida loca.
UNI 2223 PN10.
En C-PVC para manguito portabridas..

RIM



T

dm x dh	Ref.	Pack	€
25 x 20	RIM025020	10	3,28
32 x 20	RIM032020	10	3,98
32 x 25	RIM032025	10	3,98
40 x 25	RIM040025	10	4,72
40 x 32	RIM040032	10	4,72
50 x 32	RIM050032	5	6,12
50 x 40	RIM050040	5	5,98
63 x 32	RIM063032	5	7,13
63 x 50	RIM063050	5	7,31
75 x 50	RIM075050	-	13,07
75 x 63	RIM075063	-	13,07
90 x 63	RIM090063	-	18,22
90 x 75	RIM090075	-	17,92
110 x 63	RIM110063	-	24,99
110 x 90	RIM110090	-	25,79

Reducción cónica.
M-H para fusión socket.

GRAM



T

d	Ref.	Pack	€
3/4"	GRAM034	10	7,04
1"	GRAM100	10	7,64
1 1/4"	GRAM114	10	9,56
1 1/2"	GRAM112	5	11,05
3"	GRAM300	-	46,87

Manguito portabridas estriado ANSI 150 lbs.
H para fusión socket.

ODB



T1

d	Ref.	DN	€
20	ODB020	15	9,84
25	ODB025	20	10,82
32	ODB032	25	13,95
40	ODB040	32	16,91
50	ODB050	40	19,77
63	ODB063	50	24,58
75	ODB075	65	27,17
90	ODB090	80	32,36
**125	ODB125	100	39,05

Brida loca.
En PP con alma de acero.
PN10. Para manguito portabridas.
Versión ANSI 150 lbs (ver OAB página 320)

Más diámetros en página 320
** Para usar con portabridas QRNM110

CIM



T

d	Ref.	Pack	€	
20	CIM020	10	3,06	
25	CIM025	10	3,06	
32	CIM032	10	3,79	
40	CIM040	5	4,48	
50	CIM050	5	6,41	
63	CIM063	2	8,27	
75	CIM075	-	15,15	
90	CIM090	-	17,56	
110	CIM110	-	24,27	

Tapón.

H para fusión socket.

AIM



T

d x P1 x P2	Ref.	Pack	€	
20 x 22 x 20	AIM020022020	10	3,46	
25 x 27 x 25	AIM025027025	10	4,39	
32 x 32 x 30	AIM032032030	10	5,35	
40 x 42 x 40	AIM040042040	5	9,27	
50 x 52 x 50	AIM050052050	5	11,55	
63 x 64 x 60	AIM063064060	5	12,84	

Espiga.

M para fusión socket.

BIGM



T

d	Ref.	Pack	€	
			EPDM	FKM
20	BIGM020E	10	13,24	15,36
25	BIGM025E	10	14,64	16,81
32	BIGM032E	10	16,81	19,90
40	BIGM040E	2	21,28	26,65
50	BIGM050E	2	30,39	37,47
63	BIGM063E	2	43,36	51,65

Unión 3 piezas.

H-H para fusión socket.

Código en FKM termina en "F" en lugar de "E"

BIFGM



T

d x Rh	Ref.	Pack	€	
			EPDM	FKM
20 x 1/2"	BIFGM020012E	10	19,90	23,30
25 x 3/4"	BIFGM025034E	10	21,89	25,08
32 x 1"	BIFGM032100E	10	22,93	27,39
40 x 1 1/4"	BIFGM040114E	2	35,79	45,50
50 x 1 1/2"	BIFGM050112E	2	52,35	64,95
63 x 2"	BIFGM063200E	2	60,12	71,32

Unión 3 piezas.

H-H para fusión socket-roskar.

Código en FKM termina en "F" en lugar de "E"

BIFOM



T

d x Rh	Ref.	Pack	€	
			EPDM	
20 x 1/2"	BIFOM020012E	40	23,33	
25 x 3/4"	BIFOM025034E	16	28,42	
32 x 1"	BIFOM032100E	10	35,55	
40 x 1 1/4"	BIFOM040114E	8	43,84	
50 x 1 1/2"	BIFOM050112E	4	56,61	
63 x 2"	BIFOM063200E	-	73,51	

Unión 3 piezas mixto PP-H / latón.

Junta en EPDM.

H-H para fusión socket-roskar latón.

BIROM



T

d x Rm	Ref.	Pack	€	
			EPDM	
20 x 1/2"	BIROM020012E	35	26,26	
25 x 3/4"	BIROM025034E	15	31,72	
32 x 1"	BIROM032100E	8	40,75	
40 x 1 1/4"	BIROM040114E	8	53,78	
50 x 1 1/2"	BIROM050112E	4	66,22	
63 x 2"	BIROM063200E	-	85,39	

Unión 3 piezas mixto PP-H / latón.

Junta en EPDM.

H-M para fusión socket-roskar latón.



INDUSTRIA

Sistema PP-H Socket

Válvulas de bola



VKDIM

d	Ref. EPDM	DN	€ EPDM	€ FKM
16	VKDIM016E	10	56,39	68,14
20	VKDIM020E	15	56,56	68,24
25	VKDIM025E	20	66,78	79,10
32	VKDIM032E	25	82,47	100,87
40	VKDIM040E	32	102,18	122,75
50	VKDIM050E	40	132,28	156,02
63	VKDIM063E	50	164,92	208,55

Válvula de bola DUAL BLOCK®. Código en FKM termina en "F" en lugar de "E"
Asiento PTFE (teflón). Bidireccional.
H-H para fusión socket.



VKDFM

Rh	Ref. EPDM	DN	€ EPDM	€ FKM
1/2"	VKDFM012E	15	66,78	79,10
3/4"	VKDFM034E	20	74,96	87,98
1"	VKDFM100E	25	106,33	119,92
1 1/4"	VKDFM114E	32	113,07	136,30
1 1/2"	VKDFM112E	40	145,83	170,40
2"	VKDFM200E	50	186,79	231,77

Válvula de bola DUAL BLOCK®. Código en FKM termina en "F" en lugar de "E"
Asiento PTFE (teflón). Bidireccional.
H-H rosca.



VKDIM

d	Ref. EPDM	DN	€ EPDM	€ FKM
75	VKDIM075E	65	396,33	592,25
90	VKDIM090E	80	498,17	742,60
110	VKDIM110E	100	603,14	975,20

Válvula de bola DUAL BLOCK®. Código en FKM termina en "F" en lugar de "E"
Asiento PTFE (teflón). Bidireccional.
H-H para fusión socket.



VKDDM

d	Ref. EPDM	DN	€ EPDM	€ FKM
20	VKDDM020E	15	56,56	68,24
25	VKDDM025E	20	66,78	79,10
32	VKDDM032E	25	82,47	100,87
40	VKDDM040E	32	102,18	122,75
50	VKDDM050E	40	132,28	156,02
63	VKDDM063E	50	164,92	208,55

Válvula de bola DUAL BLOCK®. Código en FKM termina en "F" en lugar de "E"
Asiento PTFE (teflón). Bidireccional.
M-M para fusión socket.



VKDOM

d	Ref. EPDM	DN	€ EPDM	€ FKM
20	VKDOM020E	15	114,05	131,73
25	VKDOM025E	20	133,97	151,74
32	VKDOM032E	25	167,59	193,81
40	VKDOM040E	32	218,68	246,84
50	VKDOM050E	40	259,37	279,80
63	VKDOM063E	50	319,84	370,89

Válvula de bola DUAL BLOCK®. Código en FKM termina en "F" en lugar de "E"
Con brida loca. Asiento PTFE (teflón). Bidireccional.
Versión con bridas ANSI 150 lbs al mismo precio.



VKDDM

d	Ref. EPDM	DN	€ EPDM	€ FKM
75	VKDDM075E	65	396,33	499,72
90	VKDDM090E	80	498,17	628,18
110	VKDDM110E	100	603,14	733,09

Válvula de bola DUAL BLOCK®. Código en FKM termina en "F" en lugar de "E"
Asiento PTFE (teflón). Bidireccional.
M-M para fusión socket.



VKDOM

d	Ref. EPDM	DN	€ EPDM	€ FKM
75	VKDOM075E	65	535,06	638,48
90	VKDOM090E	80	672,54	802,51
110	VKDOM110E	100	814,26	944,19

Válvula de bola DUAL BLOCK®. Código en FKM termina en "F" en lugar de "E"
Con brida loca. Asiento PTFE (teflón). ANSI y DIN Bidireccional.



VKRIM

V

d	Ref. EPDM	DN	€ EPDM	€ FKM
16	VKRIM016E	10	230,92	242,64
20	VKRIM020E	15	231,05	242,72
25	VKRIM025E	20	256,06	268,39
32	VKRIM032E	25	301,84	320,25
40	VKRIM040E	32	338,21	358,79
50	VKRIM050E	40	419,80	443,59
63	VKRIM063E	50	446,80	490,46

Válvula de bola REGULACIÓN
DUAL BLOCK®.

Asiento PTFE (teflón). Bidireccional
H-H para fusión socket.

Código en FKM termina en "F"
en lugar de "E"



VKRFM

V

Rh	Ref. EPDM	DN	€ EPDM	€ FKM
3/8"	VKRFM038E	10	241,26	253,61
1/2"	VKRFM012E	15	241,26	253,61
3/4"	VKRFM034E	20	264,22	277,24
1"	VKRFM100E	25	325,74	339,31
1 1/4"	VKRFM114E	32	349,11	372,32
1 1/2"	VKRFM112E	40	433,33	457,92
2"	VKRFM200E	50	468,66	513,66

Válvula de bola REGULACIÓN
DUAL BLOCK®.

Asiento PTFE (teflón). Bidireccional
H-H roscar.

Código en FKM termina en "F"
en lugar de "E"



VKDBM

V

d	Ref. EPDM	DN	€ EPDM	€ FKM
20	VKDBM020E	15	62,69	74,96
25	VKDBM025E	20	73,62	87,99
32	VKDBM032E	25	89,30	110,34
40	VKDBM040E	32	111,71	136,30
50	VKDBM050E	40	144,48	171,74
63	VKDBM063E	50	179,95	230,32

Válvula de bola DUAL BLOCK®.
Asiento PTFE (teflón). Bidireccional
M-M para soldadura a testa.

Código en FKM termina en "F"
en lugar de "E"



VKDBEM

V

d	Ref. EPDM	DN	€ EPDM	€ FKM
20	VKDBEM020E	15	62,69	74,96
25	VKDBEM025E	20	73,62	87,98
32	VKDBEM032E	25	89,30	110,34
40	VKDBEM040E	32	111,71	136,30
50	VKDBEM050E	40	144,48	171,74
63	VKDBEM063E	50	179,95	230,32

Válvula de bola DUAL BLOCK®.
Asiento PTFE (teflón). Bidireccional
M-M para soldadura a testa.

Código en FKM termina en "F"
en lugar de "E"



VKDBM

V

d	Ref. EPDM	DN	€ EPDM	€ FKM
75	VKDBM075E	65	435,55	538,95
90	VKDBM090E	80	548,29	678,27
110	VKDBM110E	100	662,58	792,54

Válvula de bola DUAL BLOCK®.
Asiento PTFE (teflón). Bidireccional
M-M para soldadura a testa.

Código en FKM termina en "F"
en lugar de "E"



VKDBEM

V

d	Ref. EPDM	DN	€ EPDM	€ FKM
75	VKDBEM075E	65	435,55	538,95
90	VKDBEM090E	80	548,29	678,27
110	VKDBEM110E	100	662,58	792,54

Válvula de bola DUAL BLOCK®.
Asiento PTFE (teflón). Bidireccional
Long spigot PE100 SDR11.

Código en FKM termina en "F"
en lugar de "E"



INDUSTRIA

Sistema PP-H Socket

Válvulas de 3 vías



VKROM

V

d	Ref. EPDM	DN	€ EPDM	€ FKM
20	VKROM020E	15	288,56	306,23
25	VKROM025E	20	323,24	341,02
32	VKROM032E	25	386,95	413,22
40	VKROM040E	32	454,72	482,86
50	VKROM050E	40	546,90	567,34
63	VKROM063E	50	601,72	652,78

Válvula de bola **REGULACIÓN**
DUAL BLOCK®.
Asiento PTFE (teflón). Bidireccional
Con Brida DIN 2501

Código en FKM termina en "F"
en lugar de "E"



VKROAM

V

d	Ref. EPDM	DN	€ EPDM	€ FKM
1/2"	VKROAM012E	15	288,56	306,23
3/4"	VKROAM034E	20	323,24	341,02
1"	VKROAM100E	25	386,95	413,22
1 1/4"	VKROAM114E	32	454,72	482,86
1 1/2"	VKROAM112E	40	546,90	567,34
2"	VKROAM200E	50	601,72	652,78

Válvula de bola **REGULACIÓN**
DUAL BLOCK®.
Asiento PTFE (teflón). Bidireccional
Con bridas ANSI 150 lbs.

Código en FKM termina en "F"
en lugar de "E"



TKDIM

V

d x d x Rh	Ref. EPDM	DN	Apertura	€ EPDM	€ FKM
32 x 32 x 1/4"	TKDIM032ED	25	Derecha	Consultar	
32 x 32 x 1/4"	TKDIM032ES	25	Izquierda	Consultar	

Válvula de bola 3 vías
DESALACIÓN DUAL BLOCK®.
H-H-H para fusión socket-rosca 1/4"
toma muestras. Asiento PTFE (teflón).

Bajo pedido
suministramos otros diámetros
Disponibles también
con juntas en FKM



TKDIM

V

d	Ref. EPDM	DN	€ EPDM	€ FKM
20	TKDIM020E	15	101,46	114,65
25	TKDIM025E	20	114,00	131,08
32	TKDIM032E	25	146,28	168,21
40	TKDIM040E	32	166,85	196,88
50	TKDIM050E	40	197,49	246,87
63	TKDIM063E	50	249,72	312,15

Válvula de bola 3 vías
DUAL BLOCK®. **PASO T.**
H-H-H para fusión socket. Asiento PTFE
(teflón).

Código en FKM termina en "F"
en lugar de "E"



TKDFM

V

Rh	Ref. EPDM	DN	€ EPDM	€ FKM
1/2"	TKDFM012E	15	112,91	126,11
3/4"	TKDFM034E	20	127,15	144,22
1"	TKDFM100E	25	163,11	185,07
1 1/4"	TKDFM114E	32	186,56	216,59
1 1/2"	TKDFM112E	40	222,16	271,51
2"	TKDFM200E	50	280,97	343,39

Válvula de bola 3 vías
DUAL BLOCK®. **PASO T.**
H-H-H roscar. Asiento PTFE (teflón).

Código en FKM termina en "F"
en lugar de "E"



LKDIM

V

d	Ref. EPDM	DN	€ EPDM	€ FKM
20	LKDIM020E	15	118,63	131,85
25	LKDIM025E	20	133,69	150,78
32	LKDIM032E	25	171,52	193,50
40	LKDIM040E	32	196,45	226,46
50	LKDIM050E	40	234,47	283,87
63	LKDIM063E	50	296,53	359,02

Válvula de bola 3 vías
DUAL BLOCK®. **PASO L.**
H-H-H para fusión socket. Asiento PTFE
(teflón).

Código en FKM termina en "F"
en lugar de "E"



INDUSTRIA

Sistema PP-H Socket

Válvulas de mariposa



LKDFM

V

Rh	Ref. EPDM	DN	€ EPDM	€ FKM
1/2"	LKDFM012E	15	130,09	143,30
3/4"	LKDFM034E	20	146,79	163,87
1"	LKDFM100E	25	188,34	210,30
1 1/4"	LKDFM114E	32	216,07	246,15
1 1/2"	LKDFM112E	40	259,20	308,53
2"	LKDFM200E	50	327,76	390,21

Válvula de bola 3 vías
DUAL BLOCK®. **PASO L.**
H-H-H roscar. Asiento PTFE (teflón).

Código en FKM termina en "F"
en lugar de "E"



SETFLOM

V

d DIN	d ANSI	Ref. DIN	€ DIN 2501	€ ANSI
20	1/2"	SETFLOM020	41,31	41,31
25	3/4"	SETFLOM025	47,78	47,78
32	1"	SETFLOM032	52,43	52,43
40	1 1/4"	SETFLOM040	69,51	69,51
50	1 1/2"	SETFLOM050	72,30	72,30
63	2"	SETFLOM063	92,35	92,35
75	2 1/2"	SETFLOM075	205,75	205,75
90	3"	SETFLOM090	249,99	249,99
110	4"	SETFLOM110	292,12	292,12

Set embrizado d. 75-90-110,
Compuesto por 1 brida, 1 anillo fijación y 1 tuerca. es el mismo artículo
Para Válvulas VKD / VKR / TKD / RVU / VRU. para DIN y ANSI



FKOM/FM

G

d	Ref. EPDM	DN	€ EPDM	€ FKM
50	FKOMFM050E	40	251,72	379,52
63	FKOMFM063E	50	266,55	401,85
75	FKOMFM075E	65	296,17	446,47
90	FKOMFM090E	80	321,96	479,03
110	FKOMFM110E	100	350,01	512,65
125	FKOMFM140E	125	464,43	686,56
140	FKOMFM140E	125	464,43	686,56
160	FKOMFM160E	150	512,65	737,05
200	FKOMFM225E	200	664,12	956,94
225	FKOMFM225E	200	664,12	956,94
250**	FKOMFM280E	250	2.116,07	3.424,28
280**	FKOMFM280E	250	2.116,07	3.424,28
315**	FKOMFM315E	300	2.307,95	3.733,97
355**	FKOMFM355E	350	3.625,63	6.593,02
400**	FKOMFM400E	400	4.187,77	8.470,86

Válvula de mariposa industrial.
A EJE LIBRE.
Para actuar. Cuerpo en PPGR,
eje inoxidable y disco en PP-H.

Código en FKM termina en "F"
en lugar de "E"
** ANSI 150 lbs bajo pedido
al mismo precio.



FKOM/LM

G

d	Ref. EPDM	DN	€ EPDM	€ FKM
50	FKOMLM050E	40	295,60	421,50
63	FKOMLM063E	50	312,98	446,25
75	FKOMLM075E	65	347,76	495,83
90	FKOMLM090E	80	365,69	520,53
110	FKOMLM110E	100	397,14	556,42
125	FKOMLM140E	125	527,25	745,99
140	FKOMLM140E	125	527,25	745,99
160	FKOMLM160E	150	569,86	776,30
200	FKOMLM225E	200	738,13	1.007,39
225	FKOMLM225E	200	738,13	1.007,39

Válvula de mariposa industrial.
CON MANETA.
Cuerpo en PPGR,
eje inoxidable y disco en PP-H.

Código en FKM termina en "F"
en lugar de "E"



FKOM/RM

G

d	Ref. EPDM	DN	€ EPDM	€ FKM
75	FKOMRM075E	65	798,76	945,69
90	FKOMRM090E	80	816,68	970,39
110	FKOMRM110E	100	848,06	1.007,39
125	FKOMRM140E	125	978,26	1.197,00
140	FKOMRM140E	125	978,26	1.197,00
160	FKOMRM160E	150	1.020,87	1.227,29
200	FKOMRM225E	200	1.291,23	1.560,48
225	FKOMRM225E	200	1.291,23	1.560,48
250**	FKOMRM280E	250	2.436,94	3.745,21
280**	FKOMRM280E	250	2.436,94	3.745,21
315**	FKOMRM315E	300	2.628,81	4.054,83
355**	FKOMRM355E	350	4.452,87	7.420,28
400**	FKOMRM400E	400	5.015,02	9.298,07

Válvula de mariposa industrial.

CON VOLANTE.

Cuerpo en PPGR,

eje inoxidable y disco en PP-H.

Código en FKM termina en "F"

en lugar de "E"

** ANSI 150 lbs bajo pedido
al mismo precio.

FKOM/RM

G

d	Ref. EPDM	DN	€ EPDM	€ FKM
75	FKOLMRM075E	65	937,84	1.084,80
90	FKOLMRM090E	80	998,45	1.152,10
110	FKOLMRM110E	100	1.045,57	1.204,84
125	FKOLMRM140E	125	1.241,85	1.460,62
140	FKOLMRM140E	125	1.241,85	1.460,62
160	FKOLMRM160E	150	1.305,85	1.512,22
200	FKOLMRM225E	200	1.586,25	1.855,49
225	FKOLMRM225E	200	1.586,25	1.855,49

Válvula de mariposa industrial.

CON VOLANTE. LUG ISO-DIN

Cuerpo en PPGR,

eje inoxidable y disco en PP-H.

Código en FKM termina en "F"

en lugar de "E"



FKOM/LM

G

d	Ref. EPDM	DN	€ EPDM	€ FKM
75	FKOLMLM075E	65	486,88	634,95
90	FKOLMLM090E	80	547,45	702,27
110	FKOLMLM110E	100	594,58	753,89
125	FKOLMLM140E	125	790,86	1.009,61
140	FKOLMLM140E	125	790,86	1.009,61
160	FKOLMLM160E	150	854,85	1.061,25
200	FKOLMLM225E	200	1.033,24	1.302,44
225	FKOLMLM225E	200	1.033,24	1.302,44

Válvula de mariposa industrial.

CON MANETA. LUG ISO-DIN

Cuerpo en PPGR,

eje inoxidable y disco en PP-H.

Código en FKM termina en "F"

en lugar de "E"



FKOM/LM

G

d	Ref. EPDM	DN	€ EPDM	€ FKM
½"	FKOALMLM212E	65	556,42	704,48
3"	FKOALMLM300E	80	620,32	775,18
4"	FKOALMLM400E	100	674,23	833,50
5"	FKOALMLM500E	125	896,32	1.115,09
6"	FKOALMLM600E	150	969,25	1.175,66
8"	FKOALMLM800E	200	1.180,09	1.449,35

Válvula de mariposa industrial.

CON MANETA. LUG ANSI

Cuerpo en PPGR,

eje inoxidable y disco en PP-H.

Código en FKM termina en "F"

en lugar de "E"



FKOM/RM

G

d	Ref. EPDM	DN	€ EPDM	€ FKM
2½"	FKOALMRM212E	65	1.007,39	1.154,36
3"	FKOALMRM300E	80	1.071,33	1.225,02
4"	FKOALMRM400E	100	1.125,18	1.284,52
5"	FKOALMRM500E	125	1.347,33	1.566,04
6"	FKOALMRM600E	150	1.420,25	1.626,63
8"	FKOALMRM800E	200	1.733,18	2.002,43
10"	FKOALMRM810E	250	3.851,38	5.159,64
12"	FKOALMRM812E	300	4.075,62	5.501,66

Válvula de mariposa industrial.

CON VOLANTE. LUG ANSI

Cuerpo en PPGR,

eje inoxidable y disco en PP-H.

Código en FKM termina en "F"

en lugar de "E"



INDUSTRIA

Sistema PP-H Socket Válvulas de membrana



DKDM



U

d	Ref. EPDM	DN	PN	€ EPDM	€ FKM	€ PTFE
20	DKDM020E	15	10	102,49	158,66	182,58
25	DKDM025E	20	10	110,93	169,90	192,41
32	DKDM032E	25	10	130,55	188,12	210,66
40	DKDM040E	32	10	153,00	248,56	275,12
50	DKDM050E	40	10	199,32	294,86	321,45
63	DKDM063E	50	10	241,54	402,90	400,17
75	DKDM075E	65	10	289,86	483,47	480,20

Válvula de membrana
DIALOCK®.
M-M para soldar socket.

Código en FKM termina en "F"
en lugar de "E"
Código en PTFE termina en "P"
en lugar de "E"

DKOM



U

d	Ref. EPDM	DN	PN	€ EPDM	€ FKM	€ PTFE
20	DKOM020E	15	10	155,18	211,34	235,23
25	DKOM025E	20	10	166,72	225,70	248,22
32	DKOM032E	25	10	188,29	245,85	268,37
40	DKOM040E	32	10	229,07	324,61	351,18
50	DKOM050E	40	10	278,90	374,39	400,99
63	DKOM063E	50	10	351,94	513,36	510,57
75	DKOM075E	65	10	457,51	667,34	663,72

Válvula de membrana
DIALOCK®.
Con bridas DIN.

Código en FKM termina en "F"
en lugar de "E"
Código en PTFE termina en "P"
en lugar de "E"

VMDM



U

d	Ref. EPDM	DN	€ EPDM	€ FKM	€ PTFE
90	VMDM090E	80	644,42	1.104,90	859,20
110	VMDM110E	100	856,44	1.620,12	1.121,74

Válvula de membrana.
M-M para fusión socket.

Código en FKM termina en "F"
en lugar de "E"
Código en PTFE termina en "P"
en lugar de "E"
*PNG

VMOM



U

d	Ref. EPDM	DN	€ EPDM	€ FKM	€ PTFE
90	VMOM090E	80	861,25	1.321,71	1.076,05
110	VMOM110E	100	1.102,93	1.866,59	1.368,21

Válvula de membrana.
Con bridas DIN. Bajo pedido
con bridas ANSI 150 lbs. mismo precio.

Código en FKM termina en "F"
en lugar de "E"
Código en PTFE termina en "P"
en lugar de "E"
*PNG

DKOAM



U

d	Ref. EPDM	DN	PN	€ EPDM	€ FKM	€ PTFE
½"	DKOAM012E	15	10	155,18	211,34	235,23
¾"	DKOAM034E	20	10	166,72	225,70	248,22
1"	DKOAM100E	25	10	188,29	245,85	268,37
1¼"	DKOAM114E	32	10	229,07	324,61	351,18
1½"	DKOAM112E	40	10	278,90	374,39	400,99
2"	DKOAM200E	50	10	351,94	513,36	510,57
2½"	DKOAM212E	65	10	457,51	667,34	663,72

Válvula de membrana
DIALOCK®.
Con bridas ANSI 150 lbs.

Código en FKM termina en "F"
en lugar de "E"
Código en PTFE termina en "P"
en lugar de "E"

DKUIM



U

d	Ref. EPDM	DN	PN	€ EPDM	€ FKM	€ PTFE
20	DKUIM020E	15	10	119,35	175,52	199,32
25	DKUIM025E	20	10	127,75	186,72	209,15
32	DKUIM032E	25	10	148,84	206,40	228,78
40	DKUIM040E	32	10	172,77	268,21	294,86
50	DKUIM050E	40	10	221,22	314,53	341,09
63	DKUIM063E	50	10	270,93	432,40	429,60

Válvula de membrana
DIALOCK®.
Con enlaces H-H para soldar socket.

Código en FKM termina en "F"
en lugar de "E"
Código en PTFE termina en "P"
en lugar de "E"



INDUSTRIA

Sistema PP-H Socket Válvulas anti-retorno



DKLUIM



U

d	Ref. EPDM	DN	PN	€ EPDM	€ FKM	€ PTFE
20	DKLUIM020E	15	10	231,58	287,73	311,52
25	DKLUIM025E	20	10	240,00	298,95	321,35
32	DKLUIM032E	25	10	261,08	318,62	340,99
40	DKLUIM040E	32	10	284,98	380,43	407,09
50	DKLUIM050E	40	10	365,51	458,81	485,37
63	DKLUIM063E	50	10	415,22	576,68	573,86

Válvula de membrana
DIALOCK®. **CON LIMITADOR
DE CARRERA.**

Con enlaces H-H para soldar socket.

Código en FKM termina en "F"
en lugar de "E"
Código en PTFE termina en "P"
en lugar de "E"

CMDM
M-M fusión
socket.

GMIM
H-H fusión
socket.

CMUIM
H-H enlaces
socket.

CMFM
H-H roscar.



U

d-Rh	Ref. EPDM	DN	€ EPDM	€ FKM	€ PTFE
20	CMDM020E	15	117,99	124,91	134,85
16	CMIM016E	12	65,97	89,89	101,12
20	CMIM020E	15	65,97	89,89	101,12
20	CMUIM020E	15	105,25	127,75	140,38
3/8"	CMFM038E	12	65,97	89,89	101,12
1/2"	CMFM012E	15	65,97	89,89	101,12

Válvula de membrana
compacta.

Código en FKM termina en "F"
en lugar de "E"
Código en PTFE termina en "P"
en lugar de "E"

VRUIM



V

d	Ref. EPDM	DN	PN	€ EPDM	€ FKM
20	VRUIM020E	15	10	61,90	66,96
25	VRUIM025E	20	10	70,02	76,75
32	VRUIM032E	25	10	72,70	83,24
40	VRUIM040E	32	10	88,36	101,21
50	VRUIM050E	40	10	99,97	122,39
63	VRUIM063E	50	10	152,79	186,01

Válvula anti-retorno inclinada.
Juntas en EPDM o FKM.

H-H con enlaces para fusión socket

Código en FKM termina en "F"
en lugar de "E"

VRUFM



V

Rh	Ref. EPDM	DN	PN	Pack	€ FKM
1/2"	VRUFM012F	15	10	2	70,99
3/4"	VRUFM034F	20	10	2	81,31
1"	VRUFM100F	25	10	2	89,89
1 1/4"	VRUFM114F	32	10	2	107,27
1 1/2"	VRUFM112F	40	10	2	129,77
2"	VRUFM200F	50	10	2	195,29

Válvula anti-retorno inclinada.
Juntas en FKM.

H-H con enlaces para roscar.

VRIM



V

d	Ref. EPDM	DN	PN	€ EPDM	€ FKM
75	VRIM075E	65	6	342,94	373,51
90	VRIM090E	80	4	560,11	614,85

Válvula anti-retorno inclinada.
Juntas en EPDM o FKM.

H-H para fusión socket
(sin enlaces en los extremos).

Código en FKM termina en "F"
en lugar de "E"

RVUIM

V

d	Ref. EPDM	DN	PN	€ EPDM	€ FKM
20	RVUIM020E	15	10	72,31	78,51
25	RVUIM025E	20	10	90,39	97,90
32	RVUIM032E	25	10	109,42	114,54
40	RVUIM040E	32	10	119,83	133,27
50	RVUIM050E	40	10	130,61	153,68
63	RVUIM063E	50	10	180,43	211,58

Filtro inclinado.

Juntas en EPDM o FKM.

H-H con enlaces para fusión socket.

Código en FKM termina en "F"
en lugar de "E"
RVUFM

V

Rh	Ref. EPDM	DN	PN	Pack	€ FKM
1/2"	RVUFM012F	15	10	2	83,24
3/4"	RVUFM034F	20	10	2	103,82
1"	RVUFM100F	25	10	2	123,73
1 1/4"	RVUFM114F	32	10	2	141,26
1 1/2"	RVUFM112F	40	10	2	162,91
2"	RVUFM200F	50	10	2	222,14

Filtro inclinado.

Juntas en FKM.

H-H con enlaces para roscar.

RVIM

V

d	Ref. EPDM	DN	PN	€ EPDM	€ FKM
75	RVIM075E	65	6	231,00	235,80
90	RVIM090E	80	4	285,84	302,62
110	RVIM110E	100	4	523,27	595,79

Filtro inclinado.

Juntas en EPDM o FKM.

H-H para fusión socket

(sin enlaces en los extremos).

Código en FKM termina en "F"
en lugar de "E"
SRIM

V

d	Ref. EPDM	DN	PN	Pack	€ FKM
20	SRIM020F	15	10	2	64,05
25	SRIM025F	20	10	2	70,92
32	SRIM032F	25	10	2	77,73
40	SRIM040F	32	10	2	95,47
50	SRIM050F	40	10	2	113,07
63	SRIM063F	50	10	2	169,72

Válvula de bola anti-retorno.

Juntas en FKM.

M-H para fusión socket.

**FROM**

V

d	Ref. EPDM	DN	PN	€ EPDM	€ FKM
40	FROM040E	32	6	295,71	478,84
50	FROM050E	40	6	295,71	485,25
63	FROM063E	50	6	313,57	514,48
75	FROM075E	65	6	384,74	638,49
90	FROM090E	80	6	419,70	715,45
110	FROM110E	100	6	515,73	857,94
140	FROM140E	125	6	686,18	1.076,72
160	FROM160E	150	6	709,67	1.165,00
225	FROM225E	200	6	892,91	1.378,07
280	FROM280E	250	6	1.365,95	2.022,97
315	FROM315E	300	6	1.916,12	2.696,99

Válvula anti-retorno de clapeta sin resorte.
ISO/DIN

Código en FKM termina en "F" en lugar de "E"

**FROM**

V

d	Ref. EPDM	DN	PN	€ EPDM	€ FKM
40	FROM040EMLX	32	6	394,89	578,05
50	FROM050EMLX	40	6	394,89	584,46
63	FROM063EMLX	50	6	419,07	620,04
75	FROM075EMLX	65	6	495,99	749,71
90	FROM090EMLX	80	6	536,69	832,41
110	FROM110EMLX	100	6	644,82	986,99
140	FROM140EMLX	125	6	815,27	1.205,75
160	FROM160EMLX	150	6	876,10	1.331,49
225	FROM225EMLX	200	6	1.082,88	1.568,05
280	FROM280EMLX	250	6	1.593,04	2.250,04
315	FROM315EMLX	300	6	2.178,14	2.959,03

Válvula anti-retorno de clapeta con resorte inox.
ISO/DIN

Código en FKM termina en "F" en lugar de "E"

**FROAM**

V

d	Ref. EPDM	DN	PN	€ EPDM	€ FKM
1¼"	FROAM114E	32	6	363,42	546,55
1½"	FROAM112E	40	6	346,92	542,81
2"	FROAM200E	50	6	376,61	577,58
2½"	FROAM212E	65	6	457,12	710,85
3"	FROAM300E	80	6	504,02	799,73
4"	FROAM400E	100	6	611,69	960,19
5"	FROAM500E	125	6	814,62	1.205,11
6"	FROAM600E	150	6	836,43	1.291,74
8"	FROAM800E	200	6	1.085,38	1.570,61
10"	FROAM810E	250	6	1.613,89	2.270,79
12"	FROAM812E	300	6	2.328,16	3.109,12

Válvula anti-retorno de clapeta sin resorte.
ANSI 150 lbs.

Código en FKM termina en "F" en lugar de "E"

**FROAM**

V

d	Ref. EPDM	DN	PN	€ EPDM	€ FKM
40	FROAM114EMLX	32	6	462,60	645,73
50	FROAM112EMLX	40	6	446,11	641,97
63	FROAM200EMLX	50	6	482,12	683,09
75	FROAM212EMLX	65	6	568,38	822,11
90	FROAM300EMLX	80	6	621,02	916,68
110	FROAM400EMLX	100	6	740,76	1.089,23
140	FROAM500EMLX	125	6	943,71	1.334,17
160	FROAM600EMLX	150	6	1.002,88	1.458,18
225	FROAM800EMLX	200	6	1.275,39	1.760,62
280	FROAM810EMLX	250	6	1.840,94	2.497,86
315	FROAM812EMLX	300	6	2.590,21	3.371,14

Válvula anti-retorno de clapeta con resorte inox.
ANSI 150 lbs.

Código en FKM termina en "F" en lugar de "E"



INDUSTRIA

Sistema PP-H Socket

Válvulas de bola actuadas



K

VKDIM/CE

soldar.

VKDFM/CE

roscar.

ACTUACIÓN ELÉCTRICA

ACTUACIÓN ELÉCTRICA CON BLOQUEO DE SEGURIDAD

d-Rh	24-240 V AC/DC €		24-240 V AC/DC €		24-240 V AC/DC €		24-240 V AC/DC €	
	Ref.	EPDM	Ref.	FKM	Ref.	EPDM	Ref.	FKM
16	VKME016E2D	748,47	VKME016F2D	765,34	VKME016E2BD	1.382,01	VKME016F2BD	1.398,88
20	VKME020E2D	748,65	VKME020F2D	765,47	VKME020E2BD	1.382,19	VKME020F2BD	1.399,01
25	VKME025E2D	766,66	VKME025F2D	784,38	VKME025E2BD	1.400,22	VKME025F2BD	1.417,92
32	VKME032E2D	789,22	VKME032F2D	815,72	VKME032E2BD	1.422,77	VKME032F2BD	1.449,25
40	VKME040E2D	825,86	VKME040F2D	855,50	VKME040E2BD	1.459,41	VKME040F2BD	1.489,06
50	VKME050E2D	869,16	VKME050F2D	903,33	VKME050E2BD	1.502,73	VKME050F2BD	1.536,89
63	VKME063E2D	920,23	VKME063F2D	983,05	VKME063E2BD	1.553,79	VKME063F2BD	1.616,61
75	VKME075E2D	1.480,48	VKME075F2D	1.629,37	VKME075E2BD	2.114,04	VKME075F2BD	2.262,89
90	VKME090E2D	1.627,19	VKME090F2D	1.814,35	VKME090E2BD	2.260,73	VKME090F2BD	2.447,91
110	VKME110E2D	2.209,66	VKME110F2D	2.396,71	VKME110E2BD	2.843,18	VKME110F2BD	3.030,27
3/8"	VKME038E2D	763,37	VKME038F2D	781,12	VKME038E2BD	1.396,89	VKME038F2BD	1.414,65
1/2"	VKME012E2D	763,37	VKME012F2D	781,12	VKME012E2BD	1.396,89	VKME012F2BD	1.414,65
3/4"	VKME034E2D	778,42	VKME034F2D	797,14	VKME034E2BD	1.411,97	VKME034F2BD	1.430,70
1"	VKME100E2D	823,65	VKME100F2D	843,21	VKME100E2BD	1.457,20	VKME100F2BD	1.476,75
1 1/4"	VKME114E2D	841,58	VKME114F2D	874,94	VKME114E2BD	1.475,09	VKME114F2BD	1.508,51
1 1/2"	VKME112E2D	888,68	VKME112F2D	924,11	VKME112E2BD	1.522,25	VKME112F2BD	1.557,61
2"	VKME200E2D	951,67	VKME200F2D	1.016,46	VKME200E2BD	1.585,24	VKME200F2BD	1.650,04

Válvula de bola motorizada en PP-H 2 vías DUAL BLOCK®. Actuación eléctrica.

Disponemos de otras conexiones bajo pedido: bridas, soldar macho y roscar (NPT)
Bajo pedido podemos suministrar otros actuadores: VALPES, BELIMO...
Bajo pedido también disponibles en 12 V AC/DC

VKRIM/CE

soldar.

VKRFM/CE

roscar.

ACTUACIÓN ELÉCTRICA 24-240 V AC/DC CON POSICIONADOR 4-20 mA

d	Ref.	€ EPDM	Ref.	€ FKM	Ref.	€ EPDM	Ref.	€ FKM	Rh
16	VRME016E2PD	1.529,69	VRME016F2PD	1.546,56	VRME038E2PD	1.544,59	VRME038F2PD	1.562,37	3/8"
20	VRME020E2PD	1.529,90	VRME020F2PD	1.546,72	VRME012E2PD	1.544,59	VRME012F2PD	1.562,37	1/2"
25	VRME025E2PD	1.569,15	VRME025F2PD	1.586,96	VRME034E2PD	1.580,93	VRME034F2PD	1.599,64	3/4"
32	VRME032E2PD	1.635,13	VRME032F2PD	1.661,63	VRME100E2PD	1.669,47	VRME100F2PD	1.689,04	1"
40	VRME040E2PD	1.695,68	VRME040F2PD	1.725,25	VRME114E2PD	1.711,33	VRME114F2PD	1.744,79	1 1/4"
50	VRME050E2PD	1.813,10	VRME050F2PD	1.847,41	VRME112E2PD	1.832,58	VRME112F2PD	1.867,99	1 1/2"
63	VRME063E2PD	1.856,07	VRME063F2PD	1.918,93	VRME200E2PD	1.887,51	VRME200F2PD	1.952,34	2"

Válvula de bola REGULACIÓN motorizada en PP-H 2 vías DUAL BLOCK®.
Actuación eléctrica con posicionador 4-20 mA.

Disponemos de otras conexiones bajo pedido: bridas, soldar macho y roscar (NPT)
Bajo pedido podemos suministrar otros actuadores: VALPES, BELIMO...
Bajo pedido también disponibles en 12 V AC/DC



K

VKDIM/CP

encolar.

VKDFM/CP

roscar.

ACTUACIÓN NEUMÁTICA ALUMINIO

ACTUACIÓN NEUMÁTICA ALUMINIO CON ELECTROVÁLVULA, FINALES DE CARRERA (ELECTROMECAÑICOS) Y REGULADORES DE ESCAPE

d-Rh	DOBLE EFECTO		SIMPLE EFECTO		DOBLE EFECTO		SIMPLE EFECTO	
	Ref.	€	Ref.	€	Ref.	€	Ref.	€
16	VKMP016EDED	363,10	VKMP016ESED	398,17	VKMP016EDEFD	592,28	VKMP016ESEFD	639,45
20	VKMP020EDED	363,29	VKMP020ESED	398,37	VKMP020EDEFD	592,46	VKMP020ESEFD	639,65
25	VKMP025EDED	381,31	VKMP025ESED	416,37	VKMP025EDEFD	610,45	VKMP025ESEFD	657,64
32	VKMP032EDED	403,88	VKMP032ESED	438,94	VKMP032EDEFD	633,03	VKMP032ESEFD	680,21
40	VKMP040EDED	440,53	VKMP040ESED	475,59	VKMP040EDEFD	669,66	VKMP040ESEFD	716,85
50	VKMP050EDED	483,82	VKMP050ESED	586,98	VKMP050EDEFD	712,97	VKMP050ESEFD	828,27
63	VKMP063EDED	534,89	VKMP063ESED	728,16	VKMP063EDEFD	764,04	VKMP063ESEFD	969,42
75	VKMP075EDED	910,86	VKMP075ESED	1.047,63	VKMP075EDEFD	1.140,00	VKMP075ESEFD	1.288,91
90	VKMP090EDED	1.057,57	VKMP090ESED	1.194,32	VKMP090EDEFD	1.286,72	VKMP090ESEFD	1.435,60
110	VKMP110EDED	1.239,48	VKMP110ESED	1.723,51	VKMP110EDEFD	1.468,65	VKMP110ESEFD	1.964,79
3/8"	VKMP038EDED	378,03	VKMP038ESED	413,10	VKMP038EDEFD	607,17	VKMP038ESEFD	654,35
1/2"	VKMP012EDED	378,03	VKMP012ESED	413,10	VKMP012EDEFD	607,17	VKMP012ESEFD	654,35
3/4"	VKMP034EDED	393,07	VKMP034ESED	428,13	VKMP034EDEFD	622,22	VKMP034ESEFD	669,41
1"	VKMP100EDED	438,29	VKMP100ESED	473,38	VKMP100EDEFD	667,45	VKMP100ESEFD	714,63
1 1/4"	VKMP114EDED	456,23	VKMP114ESED	491,30	VKMP114EDEFD	685,38	VKMP114ESEFD	732,57
1 1/2"	VKMP112EDED	503,32	VKMP112ESED	606,52	VKMP112EDEFD	732,51	VKMP112ESEFD	847,78
2"	VKMP200EDED	566,36	VKMP200ESED	759,65	VKMP200EDEFD	795,51	VKMP200ESEFD	1.000,91
16	VKMP016FDED	379,99	VKMP016FSED	415,08	VKMP016FDEFD	609,14	VKMP016FSEFD	656,34
20	VKMP020FDED	380,12	VKMP020FSED	415,17	VKMP020FDEFD	609,26	VKMP020FSEFD	656,44
25	VKMP025FDED	399,03	VKMP025FSED	434,12	VKMP025FDEFD	628,21	VKMP025FSEFD	675,39
32	VKMP032FDED	430,37	VKMP032FSED	465,46	VKMP032FDEFD	659,52	VKMP032FSEFD	706,70
40	VKMP040FDED	470,15	VKMP040FSED	505,22	VKMP040FDEFD	699,32	VKMP040FSEFD	746,49
50	VKMP050FDED	517,97	VKMP050FSED	621,16	VKMP050FDEFD	747,14	VKMP050FSEFD	862,45
63	VKMP063FDED	597,69	VKMP063FSED	790,99	VKMP063FDEFD	826,87	VKMP063FSEFD	1.032,26
75	VKMP075FDED	1.059,75	VKMP075FSED	1.196,51	VKMP075FDEFD	1.288,91	VKMP075FSEFD	1.437,76
90	VKMP090FDED	1.244,72	VKMP090FSED	1.381,48	VKMP090FDEFD	1.473,88	VKMP090FSEFD	1.622,76
110	VKMP110FDED	1.426,58	VKMP110FSED	1.910,62	VKMP110FDEFD	1.655,74	VKMP110FSEFD	2.151,86
3/8"	VKMP038FDED	395,77	VKMP038FSED	430,82	VKMP038FDEFD	624,91	VKMP038FSEFD	672,08
1/2"	VKMP012FDED	395,77	VKMP012FSED	430,82	VKMP012FDEFD	624,91	VKMP012FSEFD	672,08
3/4"	VKMP034FDED	411,81	VKMP034FSED	446,83	VKMP034FDEFD	640,93	VKMP034FSEFD	688,11
1"	VKMP100FDED	457,85	VKMP100FSED	492,93	VKMP100FDEFD	687,03	VKMP100FSEFD	734,20
1 1/4"	VKMP114FDED	489,59	VKMP114FSED	524,69	VKMP114FDEFD	718,76	VKMP114FSEFD	765,92
1 1/2"	VKMP112FDED	538,74	VKMP112FSED	641,93	VKMP112FDEFD	767,88	VKMP112FSEFD	883,18
2"	VKMP200FDED	631,13	VKMP200FSED	824,43	VKMP200FDEFD	860,29	VKMP200FSEFD	1.065,68

Válvula de bola motorizada en PP-H 2 vías DUAL BLOCK®. Actuación neumática.

Disponemos de otras conexiones bajo pedido: bridas, soldar macho y roscar (NPT). Las válvulas neumáticas se configuran NC (normalmente cerrada) de serie. La configuración NA (normalmente abierta) se debe especificar en el pedido.

VKRIM/CP

soldar.

VKRFM/CP

roscar.

 ACTUACIÓN NEUMÁTICA ALUMINIO DOBLE EFECTO
 CON POSICIONADOR 4-20 mA

 ACTUACIÓN NEUMÁTICA ALUMINIO SIMPLE EFECTO
 CON POSICIONADOR 4-20 mA

K

d-Rh	Ref.	€ EPDM	Ref.	€ FKM	Ref.	€ EPDM	Ref.	€ FKM
16	VRMP016EDEPD	2.655,91	VRMP016FDEPD	2.672,80	VRMP016ESEPD	2.690,99	VRMP016FSEPD	2.707,87
20	VRMP020EDEPD	2.656,09	VRMP020FDEPD	2.672,94	VRMP020ESEPD	2.691,19	VRMP020FSEPD	2.707,96
25	VRMP025EDEPD	2.695,40	VRMP025FDEPD	2.713,16	VRMP025ESEPD	2.730,43	VRMP025FSEPD	2.748,24
32	VRMP032EDEPD	2.761,31	VRMP032FDEPD	2.787,83	VRMP032ESEPD	2.796,40	VRMP032FSEPD	2.822,90
40	VRMP040EDEPD	2.821,92	VRMP040FDEPD	2.851,51	VRMP040ESEPD	2.857,01	VRMP040FSEPD	2.886,60
50	VRMP050EDEPD	2.939,30	VRMP050FDEPD	2.973,58	VRMP050ESEPD	3.042,50	VRMP050FSEPD	3.076,78
63	VRMP063EDEPD	2.982,31	VRMP063FDEPD	3.045,13	VRMP063ESEPD	3.175,59	VRMP063FSEPD	3.238,43
3/8"	VRMP038EDEPD	2.670,83	VRMP038FDEPD	2.688,56	VRMP038ESEPD	2.705,91	VRMP038FSEPD	2.723,64
1/2"	VRMP012EDEPD	2.670,83	VRMP012FDEPD	2.688,56	VRMP012ESEPD	2.705,91	VRMP012FSEPD	2.723,64
3/4"	VRMP034EDEPD	2.707,16	VRMP034FDEPD	2.725,88	VRMP034ESEPD	2.742,20	VRMP034FSEPD	2.760,94
1"	VRMP100EDEPD	2.795,69	VRMP100FDEPD	2.815,25	VRMP100ESEPD	2.830,75	VRMP100FSEPD	2.850,33
1 1/4"	VRMP114EDEPD	2.837,55	VRMP114FDEPD	2.871,01	VRMP114ESEPD	2.872,65	VRMP114FSEPD	2.906,04
1 1/2"	VRMP112EDEPD	2.958,81	VRMP112FDEPD	2.994,21	VRMP112ESEPD	3.062,01	VRMP112FSEPD	3.097,42
2"	VRMP200EDEPD	3.013,72	VRMP200FDEPD	3.078,60	VRMP200ESEPD	3.207,03	VRMP200FSEPD	3.271,86

 Válvula de bola **REGULACIÓN** motorizada
 en PP-H 2 vías DUAL BLOCK®.

Actuación neumática con posicionador 4-20 mA.

 Disponemos de otras conexiones bajo pedido: bridas, soldar macho y roscar (NPT)
 Las válvulas neumáticas se configuran NC (normalmente cerrada) de serie.
 La configuración NA (normalmente abierta) se debe especificar en el pedido.

VKRIM/CP

soldar.

VKRFM/CP

roscar.



K

**ACTUACIÓN NEUMÁTICA POLIAMIDA DOBLE EFECTO
 CON POSICIONADOR 4-20 mA**
**ACTUACIÓN NEUMÁTICA POLIAMIDA SIMPLE EFECTO
 CON POSICIONADOR 4-20 mA**

d-Rh	Ref.	€ EPDM	Ref.	€ FKM	Ref.	€ EPDM	Ref.	€ FKM
16	VRMP016EDEPP	2.153,69	VRMP016FDEPP	2.170,58	VRMP016ESEPP	2.180,13	VRMP016FSEPP	2.197,02
20	VRMP020EDEPP	2.153,87	VRMP020FDEPP	2.170,70	VRMP020ESEPP	2.180,29	VRMP020FSEPP	2.197,14
25	VRMP025EDEPP	2.193,14	VRMP025FDEPP	2.210,92	VRMP025ESEPP	2.219,57	VRMP025FSEPP	2.237,39
32	VRMP032EDEPP	2.259,09	VRMP032FDEPP	2.285,59	VRMP032ESEPP	2.404,44	VRMP032FSEPP	2.430,94
40	VRMP040EDEPP	2.319,70	VRMP040FDEPP	2.349,28	VRMP040ESEPP	2.465,04	VRMP040FSEPP	2.494,60
50	VRMP050EDEPP	2.437,07	VRMP050FDEPP	2.471,37	VRMP050ESEPP	2.721,17	VRMP050FSEPP	2.755,43
63	VRMP063EDEPP	2.713,16	VRMP063FDEPP	2.776,00	VRMP063ESEPP	2.789,14	VRMP063FSEPP	2.851,96
3/8"	VRMP038EDEPP	2.168,61	VRMP038FDEPP	2.186,35	VRMP038ESEPP	2.195,05	VRMP038FSEPP	2.212,79
1/2"	VRMP012EDEPP	2.168,61	VRMP012FDEPP	2.168,61	VRMP012ESEPP	2.195,05	VRMP012FSEPP	2.212,79
3/4"	VRMP034EDEPP	2.204,94	VRMP034FDEPP	2.223,63	VRMP034ESEPP	2.231,39	VRMP034FSEPP	2.250,08
1"	VRMP100EDEPP	2.293,45	VRMP100FDEPP	2.313,03	VRMP100ESEPP	2.438,80	VRMP100FSEPP	2.458,35
1 1/4"	VRMP114EDEPP	2.335,32	VRMP114FDEPP	2.368,79	VRMP114ESEPP	2.480,66	VRMP114FSEPP	2.514,12
1 1/2"	VRMP112EDEPP	2.456,60	VRMP112FDEPP	2.491,99	VRMP112ESEPP	2.740,65	VRMP112FSEPP	2.776,05
2"	VRMP200EDEPP	2.744,58	VRMP200FDEPP	2.809,42	VRMP200ESEPP	2.820,54	VRMP200FSEPP	2.885,38

Válvula de bola **REGULACIÓN** motorizada en PP-H 2 vías DUAL BLOCK®.
 Actuación neumática con posicionador 4-20 mA.

Disponemos de otras conexiones bajo pedido: bridas, soldar macho y roscar (NPT).
 Las válvulas neumáticas se configuran NC (normalmente cerrada) de serie.
 La configuración NA (normalmente abierta) se debe especificar en el pedido.



K

VKDIM/CP

soldar.

VKDFM/CP

roscar.

ACTUACIÓN NEUMÁTICA POLIAMIDA

ACTUACIÓN NEUMÁTICA POLIAMIDA CON ELECTROVÁLVULA, FINALES DE CARRERA (ELECTROMECAÑICOS) Y REGULADORES DE ESCAPE

d-Rh	DOBLE EFECTO		SIMPLE EFECTO		DOBLE EFECTO		SIMPLE EFECTO	
	Ref.	€	Ref.	€	Ref.	€	Ref.	€
16	VKMP016EDEP	384,51	VKMP016ESEP	410,94	VKMP016EDEF	684,26	VKMP016ESEFP	710,71
20	VKMP020EDEP	384,70	VKMP020ESEP	411,12	VKMP020EDEF	684,46	VKMP020ESEFP	710,89
25	VKMP025EDEP	402,67	VKMP025ESEP	429,12	VKMP025EDEF	702,44	VKMP025ESEFP	728,88
32	VKMP032EDEP	425,29	VKMP032ESEP	570,63	VKMP032EDEF	725,02	VKMP032ESEFP	870,38
40	VKMP040EDEP	461,91	VKMP040ESEP	607,27	VKMP040EDEF	761,65	VKMP040ESEFP	907,03
50	VKMP050EDEP	505,22	VKMP050ESEP	789,29	VKMP050EDEF	804,99	VKMP050ESEFP	1.089,06
63	VKMP063EDEP	789,34	VKMP063ESEP	865,33	VKMP063EDEF	1.089,12	VKMP063ESEFP	1.165,07
75	VKMP075EDEP	1.058,24	VKMP075ESEP	1.342,83	VKMP075EDEF	1.357,97	VKMP075ESEFP	1.642,57
90	VKMP090EDEP	1.204,94	VKMP090ESEP	1.489,51	VKMP090EDEF	1.504,70	VKMP090ESEFP	1.789,28
110	VKMP110EDEP	1.348,73	VKMP110ESEP	1.657,56	VKMP110EDEF	1.648,46	VKMP110ESEFP	1.957,33

3/8"	VKMP038EDEP	399,42	VKMP038ESEP	425,85	VKMP038EDEF	699,20	VKMP038ESEFP	725,65
1/2"	VKMP012EDEP	399,42	VKMP012ESEP	425,85	VKMP012EDEF	699,20	VKMP012ESEFP	725,65
3/4"	VKMP034EDEP	414,49	VKMP034ESEP	440,92	VKMP034EDEF	714,24	VKMP034ESEFP	740,67
1"	VKMP100EDEP	459,68	VKMP100ESEP	605,02	VKMP100EDEF	759,44	VKMP100ESEFP	904,78
1 1/4"	VKMP114EDEP	477,64	VKMP114ESEP	622,96	VKMP114EDEF	777,40	VKMP114ESEFP	922,72
1 1/2"	VKMP112EDEP	524,74	VKMP112ESEP	808,79	VKMP112EDEF	824,50	VKMP112ESEFP	1.108,56
2"	VKMP200EDEP	820,83	VKMP200ESEP	896,80	VKMP200EDEF	1.120,59	VKMP200ESEFP	1.196,55

16	VKMP016FDEP	401,39	VKMP016FSEP	427,82	VKMP016FDEF	701,14	VKMP016FSEFP	727,59
20	VKMP020FDEP	401,52	VKMP020FSEP	427,95	VKMP020FDEF	701,28	VKMP020FSEFP	727,74
25	VKMP025FDEP	420,43	VKMP025FSEP	446,83	VKMP025FDEF	720,20	VKMP025FSEFP	746,61
32	VKMP032FDEP	451,78	VKMP032FSEP	597,10	VKMP032FDEF	751,53	VKMP032FSEFP	896,87
40	VKMP040FDEP	491,55	VKMP040FSEP	636,89	VKMP040FDEF	791,32	VKMP040FSEFP	936,63
50	VKMP050FDEP	539,39	VKMP050FSEP	823,45	VKMP050FDEF	839,14	VKMP050FSEFP	1.123,21
63	VKMP063FDEP	852,20	VKMP063FSEP	928,16	VKMP063FDEF	1.151,92	VKMP063FSEFP	1.227,91
75	VKMP075FDEP	1.207,09	VKMP075FSEP	1.491,66	VKMP075FDEF	1.506,86	VKMP075FSEFP	1.791,42
90	VKMP090FDEP	1.392,10	VKMP090FSEP	1.676,68	VKMP090FDEF	1.691,87	VKMP090FSEFP	1.976,42
110	VKMP110FDEP	1.535,77	VKMP110FSEP	1.844,64	VKMP110FDEF	1.835,53	VKMP110FSEFP	2.144,41

3/8"	VKMP038FDEP	417,17	VKMP038FSEP	443,60	VKMP038FDEF	716,91	VKMP038FSEFP	743,35
1/2"	VKMP012FDEP	399,42	VKMP012FSEP	443,60	VKMP012FDEF	699,20	VKMP012FSEFP	743,35
3/4"	VKMP034FDEP	433,18	VKMP034FSEP	459,60	VKMP034FDEF	732,96	VKMP034FSEFP	759,39
1"	VKMP100FDEP	479,25	VKMP100FSEP	624,58	VKMP100FDEF	779,04	VKMP100FSEFP	924,35
1 1/4"	VKMP114FDEP	510,97	VKMP114FSEP	656,34	VKMP114FDEF	810,76	VKMP114FSEFP	956,08
1 1/2"	VKMP112FDEP	560,13	VKMP112FSEP	844,18	VKMP112FDEF	859,88	VKMP112FSEFP	1.143,95
2"	VKMP200FDEP	885,60	VKMP200FSEP	961,58	VKMP200FDEF	1.185,38	VKMP200FSEFP	1.261,34

Válvula de bola motorizada en PP-H 2 vías DUAL BLOCK®. Actuación neumática.

Disponemos de otras conexiones bajo pedido: bridas, soldar macho y roscar (NPT). Las válvulas neumáticas se configuran NC (normalmente cerrada) de serie. La configuración NA (normalmente abierta) se debe especificar en el pedido.



INDUSTRIA

Sistema PP-H Socket

Válvulas de 3 vías actuadas



K

LKDIM/CE
soldar.

LKDFM/CE
rosacar.

ACTUACIÓN ELÉCTRICA

ACTUACIÓN ELÉCTRICA CON BLOQUE DE SEGURIDAD

d-Rh	24-240 V AC/DC		24-240 V AC/DC		24-240 V AC/DC		24-240 V AC/DC	
	Ref.	€	Ref.	€	Ref.	€	Ref.	€
		EPDM		FKM		EPDM		FKM
20	LKME020E2D	838,04	LKME020F2D	857,01	LKME020E2BD	1.471,59	LKME020F2BD	1.490,56
25	LKME025E2D	862,98	LKME025F2D	887,58	LKME025E2BD	1.496,51	LKME025F2BD	1.521,12
32	LKME032E2D	917,40	LKME032F2D	949,04	LKME032E2BD	1.550,96	LKME032F2BD	1.582,55
40	LKME040E2D	961,52	LKME040F2D	1.004,79	LKME040E2BD	1.595,08	LKME040F2BD	1.638,31
50	LKME050E2D	1.016,30	LKME050F2D	1.087,35	LKME050E2BD	1.649,83	LKME050F2BD	1.720,88
63	LKME063E2D	1.109,65	LKME063F2D	1.199,57	LKME063E2BD	1.743,23	LKME063F2BD	1.833,10
1/2"	LKME012E2D	854,52	LKME012F2D	873,53	LKME012E2BD	1.488,08	LKME012F2BD	1.507,06
3/4"	LKME034E2D	881,81	LKME034F2D	906,40	LKME034E2BD	1.515,37	LKME034F2BD	1.539,96
1"	LKME100E2D	941,61	LKME100F2D	973,23	LKME100E2BD	1.575,18	LKME100F2BD	1.606,79
1 1/4"	LKME114E2D	989,80	LKME114F2D	1.033,11	LKME114E2BD	1.623,33	LKME114F2BD	1.666,65
1 1/2"	LKME112E2D	1.051,87	LKME112F2D	1.122,88	LKME112E2BD	1.685,45	LKME112F2BD	1.756,44
2"	LKME200E2D	1.154,61	LKME200F2D	1.244,46	LKME200E2BD	1.788,16	LKME200F2BD	1.878,01

Válvula de bola motorizada en PP-H 3 vías DUAL BLOCK®. Actuación eléctrica.

Estándar paso en L, paso en T opcional, al mismo precio. Bajo pedido podemos suministrar otros actuadores: VALPES, BELIMO... Disponemos de otras conexiones bajo pedido: bridas, soldar macho y rosacar (NPT).
Bajo pedido también disponibles en 12 V AC/DC



K

LKDIM/CP

soldar.

LKDFM/CP

roscar.

ACTUACIÓN NEUMÁTICA ALUMINIO

ACTUACIÓN NEUMÁTICA ALUMINIO CON ELECTROVÁLVULA, FINALES DE CARRERA (ELECTROMECAÑICOS) Y REGULADORES DE ESCAPE

	d-Rh	DOBLE EFECTO		SIMPLE EFECTO		DOBLE EFECTO		SIMPLE EFECTO	
		Ref.	€	Ref.	€	Ref.	€	Ref.	€
S O L D A R E P D M	20	LKMP020EDED	452,70	LKMP020ESED	487,74	LKMP020EDEFD	681,84	LKMP020ESEFD	729,02
	25	LKMP025EDED	477,64	LKMP025ESED	512,68	LKMP025EDEFD	706,77	LKMP025ESEFD	753,97
	32	LKMP032EDED	532,08	LKMP032ESED	567,13	LKMP032EDEFD	761,21	LKMP032ESEFD	808,38
	40	LKMP040EDED	576,18	LKMP040ESED	679,36	LKMP040EDEFD	805,34	LKMP040ESEFD	920,61
	50	LKMP050EDED	671,77	LKMP050ESED	824,21	LKMP050EDEFD	900,93	LKMP050ESEFD	1.065,50
	63	LKMP063EDED	765,16	LKMP063ESED	917,61	LKMP063EDEFD	994,30	LKMP063ESEFD	1.158,89
R O S C A R E P D M	1/2"	LKMP012EDED	469,17	LKMP012ESED	504,26	LKMP012EDEFD	698,34	LKMP012ESEFD	745,52
	3/4"	LKMP034EDED	496,47	LKMP034ESED	531,55	LKMP034EDEFD	725,65	LKMP034ESEFD	772,79
	1"	LKMP100EDED	556,25	LKMP100ESED	591,35	LKMP100EDEFD	785,42	LKMP100ESEFD	832,63
	1 1/4"	LKMP114EDED	604,43	LKMP114ESED	707,63	LKMP114EDEFD	833,60	LKMP114ESEFD	948,88
	1 1/2"	LKMP112EDED	707,36	LKMP112ESED	859,83	LKMP112EDEFD	936,51	LKMP112ESEFD	1.101,08
	2"	LKMP200EDED	810,08	LKMP200ESED	962,55	LKMP200EDEFD	1.039,24	LKMP200ESEFD	1.203,83
S O L D A R F K M	20	LKMP020FDED	471,65	LKMP020FSED	506,74	LKMP020FDEFD	700,82	LKMP020FSEFD	748,02
	25	LKMP025FDED	502,23	LKMP025FSED	537,30	LKMP025FDEFD	731,40	LKMP025FSEFD	778,57
	32	LKMP032FDED	563,65	LKMP032FSED	598,73	LKMP032FDEFD	792,82	LKMP032FSEFD	840,01
	40	LKMP040FDED	619,44	LKMP040FSED	722,61	LKMP040FDEFD	848,60	LKMP040FSEFD	963,87
	50	LKMP050FDED	742,84	LKMP050FSED	895,29	LKMP050FDEFD	972,00	LKMP050FSEFD	1.136,56
	63	LKMP063FDED	855,04	LKMP063FSED	1.007,50	LKMP063FDEFD	1.084,20	LKMP063FSEFD	1.248,77
R O S C A R F K M	1/2"	LKMP012FDED	488,14	LKMP012FSED	523,23	LKMP012FDEFD	717,32	LKMP012FSEFD	764,48
	3/4"	LKMP034FDED	521,05	LKMP034FSED	556,14	LKMP034FDEFD	750,21	LKMP034FSEFD	797,42
	1"	LKMP100FDED	587,86	LKMP100FSED	622,96	LKMP100FDEFD	817,03	LKMP100FSEFD	864,20
	1 1/4"	LKMP114FDED	647,76	LKMP114FSED	750,95	LKMP114FDEFD	876,91	LKMP114FSEFD	992,22
	1 1/2"	LKMP112FDED	778,37	LKMP112FSED	930,83	LKMP112FDEFD	1.007,50	LKMP112FSEFD	1.172,08
	2"	LKMP200FDED	899,95	LKMP200FSED	1.052,40	LKMP200FDEFD	1.129,11	LKMP200FSEFD	1.293,65

Válvula de bola motorizada en PP-H 3 vías DUAL BLOCK®. Actuación neumática.

Estándar paso en L, paso en T opcional al mismo precio. Disponemos de otras conexiones bajo pedido: bridas, soldar macho y roscar (NPT). Las válvulas neumáticas se configuran NC (normalmente cerrada) de serie. La configuración NA (normalmente abierta) se debe especificar en el pedido.



K

LKDIM/CP

soldar.

LKDFM/CP

roscar.

ACTUACIÓN NEUMÁTICA POLIAMIDA

ACTUACIÓN NEUMÁTICA POLIAMIDA CON ELECTROVÁLVULA, FINALES DE CARRERA (ELECTROMECAÑICOS) Y REGULADORES DE ESCAPE

	d-Rh	DOBLE EFECTO		SIMPLE EFECTO		DOBLE EFECTO		SIMPLE EFECTO	
		Ref.	€	Ref.	€	Ref.	€	Ref.	€
S O L D A R E P D M	20	LKMP020EDEP	519,12	LKMP020ESEP	545,57	LKMP020EDEFPP	818,86	LKMP020ESEFP	845,30
	25	LKMP025EDEP	595,67	LKMP025ESEP	622,08	LKMP025EDEFPP	895,43	LKMP025ESEFP	921,86
	32	LKMP032EDEP	650,12	LKMP032ESEP	795,42	LKMP032EDEFPP	949,87	LKMP032ESEFP	1.095,18
	40	LKMP040EDEP	711,22	LKMP040ESEP	995,28	LKMP040EDEFPP	1.011,00	LKMP040ESEFP	1.295,03
	50	LKMP050EDEP	872,21	LKMP050ESEP	1.047,21	LKMP050EDEFPP	1.171,96	LKMP050ESEFP	1.346,99
	63	LKMP063EDEP	1.052,55	LKMP063ESEP	1.128,52	LKMP063EDEFPP	1.352,30	LKMP063ESEFP	1.428,28
R O S C A R E P D M	1/2"	LKMP012EDEP	535,58	LKMP012ESEP	562,02	LKMP012EDEFPP	835,34	LKMP012ESEFP	861,79
	3/4"	LKMP034EDEP	614,53	LKMP034ESEP	640,93	LKMP034EDEFPP	914,28	LKMP034ESEFP	940,72
	1"	LKMP100EDEP	674,33	LKMP100ESEP	819,67	LKMP100EDEFPP	974,09	LKMP100ESEFP	1.119,42
	1 1/4"	LKMP114EDEP	739,50	LKMP114ESEP	1.023,54	LKMP114EDEFPP	1.039,24	LKMP114ESEFP	1.323,32
	1 1/2"	LKMP112EDEP	907,79	LKMP112ESEP	1.082,82	LKMP112EDEFPP	1.207,55	LKMP112ESEFP	1.382,60
	2"	LKMP200EDEP	1.097,48	LKMP200ESEP	1.173,49	LKMP200EDEFPP	1.397,27	LKMP200ESEFP	1.473,23
S O L D A R F K M	20	LKMP020FDEP	538,07	LKMP020FSEP	564,51	LKMP020FDEFPP	837,84	LKMP020FSEFP	864,29
	25	LKMP025FDEP	620,27	LKMP025FSEP	646,69	LKMP025FDEFPP	920,02	LKMP025FSEFP	946,46
	32	LKMP032FDEP	681,70	LKMP032FSEP	827,05	LKMP032FDEFPP	981,48	LKMP032FSEFP	1.126,82
	40	LKMP040FDEP	754,46	LKMP040FSEP	1.038,55	LKMP040FDEFPP	1.054,24	LKMP040FSEFP	1.338,29
	50	LKMP050FDEP	943,26	LKMP050FSEP	1.118,29	LKMP050FDEFPP	1.243,02	LKMP050FSEFP	1.418,06
	63	LKMP063FDEP	1.142,44	LKMP063FSEP	1.218,41	LKMP063FDEFPP	1.442,22	LKMP063FSEFP	1.518,18
R O S C A R F K M	1/2"	LKMP012FDEP	554,58	LKMP012FSEP	581,01	LKMP012FDEFPP	854,35	LKMP012FSEFP	880,79
	3/4"	LKMP034FDEP	639,12	LKMP034FSEP	665,54	LKMP034FDEFPP	938,87	LKMP034FSEFP	965,29
	1"	LKMP100FDEP	705,92	LKMP100FSEP	851,26	LKMP100FDEFPP	1.005,69	LKMP100FSEFP	1.151,03
	1 1/4"	LKMP114FDEP	782,82	LKMP114FSEP	1.066,87	LKMP114FDEFPP	1.082,59	LKMP114FSEFP	1.366,62
	1 1/2"	LKMP112FDEP	978,79	LKMP112FSEP	1.153,82	LKMP112FDEFPP	1.278,55	LKMP112FSEFP	1.453,59
	2"	LKMP200FDEP	1.187,33	LKMP200FSEP	1.263,32	LKMP200FDEFPP	1.487,09	LKMP200FSEFP	1.563,07

Válvula de bola motorizada en PP-H 3 vías DUAL BLOCK®. Actuación neumática.

Estándar paso en L, paso en T opcional, al mismo precio. Disponemos de otras conexiones bajo pedido: bridas, soldar macho y roscar (NPT). Las válvulas neumáticas se configuran NC (normalmente cerrada) de serie. La configuración NA (normalmente abierta) se debe especificar en el pedido.



INDUSTRIA

Sistema PP-H Socket

Válvulas de mariposa actuadas



K

FKOM/CE

ACTUACIÓN ELÉCTRICA

ACTUACIÓN ELÉCTRICA CON BLOQUE DE SEGURIDAD

d	24-240 V AC/DC			24-240 V AC/DC			24-240 V AC/DC			24-240 V AC/DC		
	Ref.	€ EPDM	€ FKM	Ref.	€ FKM	Ref.	€ EPDM	Ref.	€ FKM	Ref.	€ FKM	
50	FKME050E2D	998,94	FKME050F2D	1.187,88	FKME050E2BD	1.632,51	FKME050F2BD	1.821,39				
63	FKME063E2D	1.020,87	FKME063F2D	1.220,90	FKME063E2BD	1.654,42	FKME063F2BD	1.854,45				
75	FKME075E2D	1.361,19	FKME075F2D	1.583,42	FKME075E2BD	1.994,75	FKME075F2BD	2.216,98				
90	FKME090E2D	1.399,35	FKME090F2D	1.631,57	FKME090E2BD	2.032,89	FKME090F2BD	2.265,14				
110	FKME110E2D	1.440,82	FKME110F2D	1.681,25	FKME110E2BD	2.074,38	FKME110F2BD	2.314,80				
125	FKME140E2D	2.027,87	FKME140F2D	2.356,19	FKME140E2BD	2.661,42	FKME140F2BD	2.989,78				
140	FKME140E2D	2.027,87	FKME140F2D	2.356,19	FKME140E2BD	2.661,42	FKME140F2BD	2.989,78				
160	FKME160E2D	2.375,43	FKME160F2D	2.707,21	FKME160E2BD	3.116,82	FKME160F2BD	3.448,61				
200	FKME225E2D	2.763,71	FKME225F2D	3.196,54	FKME225E2BD	3.505,07	FKME225F2BD	3.937,94				
225	FKME225E2D	2.763,71	FKME225F2D	3.196,54	FKME225E2BD	3.505,07	FKME225F2BD	3.937,94				
250	FKME280E2D	4.995,32	FKME280F2D	6.929,27	FKME280E2BD	5.736,71	FKME280F2BD	7.670,65				
280	FKME280E2D	4.995,32	FKME280F2D	6.929,27	FKME280E2BD	5.736,71	FKME280F2BD	7.670,65				
315	FKME315E2D	5.278,91	FKME315F2D	7.387,12	FKME315E2BD	6.020,29	FKME315F2BD	8.128,51				
355	FKME355E2D	12.646,84	FKME355F2D	17.136,33								
400	FKME400E2D	14.110,25	FKME400F2D	20.590,27								

Válvula de mariposa motorizada
cuerpo en PPGR y disco en PP-H.
Actuación eléctrica.

Bajo pedido podemos suministrar otros actuadores: VALPES, BELIMO...
Bajo pedido también disponibles en 12 V AC/DC



K

FKOM/CP

ACTUACIÓN NEUMÁTICA ALUMINIO

ACTUACIÓN NEUMÁTICA ALUMINIO CON ELECTROVÁLVULA, FINALES DE CARRERA (ELECTROMECAÑICOS) Y REGULADORES DE ESCAPE

d	DOBLE EFECTO		SIMPLE EFECTO		DOBLE EFECTO		SIMPLE EFECTO	
	Ref.	€	Ref.	€	Ref.	€	Ref.	€
50	FKMP050EDED	613,19	FKMP050ESED	716,41	FKMP050EDEFD	842,35	FKMP050ESEFD	957,67
63	FKMP063EDED	635,12	FKMP063ESED	738,33	FKMP063EDEFD	864,29	FKMP063ESEFD	979,57
75	FKMP075EDED	719,73	FKMP075ESED	872,21	FKMP075EDEFD	948,88	FKMP075ESEFD	1.113,44
90	FKMP090EDED	829,32	FKMP090ESED	966,08	FKMP090EDEFD	1.058,47	FKMP090ESEFD	1.207,36
110	FKMP110EDED	870,84	FKMP110ESED	1.385,68	FKMP110EDEFD	1.099,96	FKMP110ESEFD	1.626,93
125	FKMP140EDED	1.077,32	FKMP140ESED	1.851,06	FKMP140EDEFD	1.306,50	FKMP140ESEFD	2.092,31
140	FKMP140EDED	1.077,32	FKMP140ESED	1.851,06	FKMP140EDEFD	1.306,50	FKMP140ESEFD	2.092,31
160	FKMP160EDED	1.148,61	FKMP160ESED	1.922,30	FKMP160EDEFD	1.377,77	FKMP160ESEFD	2.163,56
200	FKMP225EDED	1.695,51	FKMP225ESED	2.757,41	FKMP225EDEFD	1.924,67	FKMP225ESEFD	2.998,66
225	FKMP225EDED	1.695,51	FKMP225ESED	2.757,41	FKMP225EDEFD	1.924,67	FKMP225ESEFD	2.998,66
250	FKMP280EDED	4.133,79	FKMP280ESED	6.385,03	FKMP280EDEFD	4.362,92	FKMP280ESEFD	6.626,31
280	FKMP280EDED	4.133,79	FKMP280ESED	6.385,03	FKMP280EDEFD	4.362,92	FKMP280ESEFD	6.626,31
315	FKMP315EDED	4.723,54	FKMP315ESED	7.831,62	FKMP315EDEFD	4.952,71	FKMP315ESEFD	8.072,90
355	FKMP355EDED	7.242,12	FKMP355ESED	9.584,32				
400	FKMP400EDED	8.092,61	FKMP400ESED	12.549,16				

50	FKMP050FDED	802,11	FKMP050FSED	905,28	FKMP050EDEFD	1.031,27	FKMP050FSEFD	1.146,57
63	FKMP063FDED	835,17	FKMP063FSED	938,37	FKMP063EDEFD	1.064,31	FKMP063FSEFD	1.179,62
75	FKMP075FDED	941,97	FKMP075FSED	1.094,41	FKMP075EDEFD	1.171,10	FKMP075FSEFD	1.335,65
90	FKMP090FDED	1.061,55	FKMP090FSED	1.198,33	FKMP090EDEFD	1.290,70	FKMP090FSEFD	1.439,61
110	FKMP110FDED	1.111,23	FKMP110FSED	1.626,07	FKMP110EDEFD	1.340,38	FKMP110FSEFD	1.867,33
125	FKMP140FDED	1.405,69	FKMP140FSED	2.179,41	FKMP140EDEFD	1.634,87	FKMP140FSEFD	2.420,69
140	FKMP140FDED	1.405,69	FKMP140FSED	2.179,41	FKMP140EDEFD	1.634,87	FKMP140FSEFD	2.420,69
160	FKMP160FDED	1.480,35	FKMP160FSED	2.254,07	FKMP160EDEFD	1.709,51	FKMP160FSEFD	2.495,34
200	FKMP225FDED	2.128,36	FKMP225FSED	3.190,26	FKMP225EDEFD	2.357,53	FKMP225FSEFD	3.431,51
225	FKMP225FDED	2.128,36	FKMP225FSED	3.190,26	FKMP225EDEFD	2.357,53	FKMP225FSEFD	3.431,51
250	FKMP280FDED	6.067,74	FKMP280FSED	8.319,00	FKMP280EDEFD	6.296,90	FKMP280FSEFD	8.560,26
280	FKMP280FDED	6.067,74	FKMP280FSED	8.319,00	FKMP280EDEFD	6.296,90	FKMP280FSEFD	8.560,26
315	FKMP315FDED	6.831,78	FKMP315FSED	9.939,83	FKMP315EDEFD	7.060,91	FKMP315FSEFD	10.181,11
355	FKMP355FDED	11.731,60	FKMP355FSED	14.073,79				
400	FKMP400FDED	14.572,61	FKMP400FSED	19.029,20				

Válvula de mariposa motorizada cuerpo en PPGR y disco en PP-H. Actuación neumática.

Las válvulas neumáticas se configuran NC (normalmente cerrada) de serie. La configuración NA (normalmente abierta) se debe especificar en el pedido.



K

FKOM/CP

ACTUACIÓN NEUMÁTICA POLIAMIDA

ACTUACIÓN NEUMÁTICA POLIAMIDA CON ELECTROVÁLVULA, FINALES DE CARRERA (ELECTROMECAÑICOS) Y REGULADORES DE ESCAPE

d	DOBLE EFECTO		SIMPLE EFECTO		DOBLE EFECTO		SIMPLE EFECTO	
	Ref.	€	Ref.	€	Ref.	€	Ref.	€
50	FKMP050EDEP	735,38	FKMP050ESEP	921,74	FKMP050EDEFPP	1.035,11	FKMP050ESEFP	1.221,51
63	FKMP063EDEP	757,29	FKMP063ESEP	943,66	FKMP063EDEFPP	1.057,05	FKMP063ESEFP	1.243,41
75	FKMP075EDEP	801,06	FKMP075ESEP	987,42	FKMP075EDEFPP	1.100,82	FKMP075ESEFP	1.287,19
90	FKMP090EDEP	949,22	FKMP090ESEP	1.025,16	FKMP090EDEFPP	1.248,98	FKMP090ESEFP	1.324,93
110	FKMP110EDEP	990,71	FKMP110ESEP	1.289,67	FKMP110EDEFPP	1.290,48	FKMP110ESEFP	1.589,43
125	FKMP140EDEP	1.150,06	FKMP140ESEP	1.791,83	FKMP140EDEFPP	1.449,81	FKMP140ESEFP	2.091,59
140	FKMP140EDEP	1.150,06	FKMP140ESEP	1.791,83	FKMP140EDEFPP	1.449,81	FKMP140ESEFP	2.091,59
160	FKMP160EDEP	1.431,01	FKMP160ESEP	1.863,09	FKMP160EDEFPP	1.730,77	FKMP160ESEFP	2.162,86
200	FKMP225EDEP	1.674,26	FKMP225ESEP	2.565,95	FKMP225EDEFPP	1.974,02	FKMP225ESEFP	2.865,71
225	FKMP225EDEP	1.674,26	FKMP225ESEP	2.565,95	FKMP225EDEFPP	1.974,02	FKMP225ESEFP	2.865,71
250*	FKMP280EDEP	4.337,88	FKMP280ESEP	6.249,39	FKMP280EDEFPP	4.637,64	FKMP280ESEFP	6.549,16
280*	FKMP280EDEP	4.337,88	FKMP280ESEP	6.249,39	FKMP280EDEFPP	4.637,64	FKMP280ESEFP	6.549,16
315*	FKMP315EDEP	4.621,48	FKMP315ESEP	6.533,00	FKMP315EDEFPP	4.921,23	FKMP315ESEFP	6.832,77
355	FKMP355EDEP	Consultar	FKMP355ESEP	Consultar				
400	FKMP400EDEP	Consultar	FKMP400ESEP	Consultar				

50	FKMP050FDEP	924,29	FKMP050FSEP	1.110,64	FKMP050FDEFPP	1.224,05	FKMP050FSEFP	1.410,41
63	FKMP063FDEP	957,33	FKMP063FSEP	1.143,68	FKMP063FDEFPP	1.257,07	FKMP063FSEFP	1.443,47
75	FKMP075FDEP	1.023,29	FKMP075FSEP	1.209,65	FKMP075FDEFPP	1.323,05	FKMP075FSEFP	1.509,40
90	FKMP090FDEP	1.181,45	FKMP090FSEP	1.257,41	FKMP090FDEFPP	1.481,23	FKMP090FSEFP	1.557,17
110	FKMP110FDEP	1.231,12	FKMP110FSEP	1.530,09	FKMP110FDEFPP	1.530,89	FKMP110FSEFP	1.829,86
125	FKMP140FDEP	1.478,38	FKMP140FSEP	2.120,16	FKMP140FDEFPP	1.778,14	FKMP140FSEFP	2.419,94
140	FKMP140FDEP	1.478,38	FKMP140FSEP	2.120,16	FKMP140FDEFPP	1.778,14	FKMP140FSEFP	2.419,94
160	FKMP160FDEP	1.762,80	FKMP160FSEP	2.194,84	FKMP160FDEFPP	2.062,54	FKMP160FSEFP	2.494,60
200	FKMP225FDEP	2.107,12	FKMP225FSEP	2.998,80	FKMP225FDEFPP	2.406,87	FKMP225FSEFP	3.298,57
225	FKMP225FDEP	2.107,12	FKMP225FSEP	2.998,80	FKMP225FDEFPP	2.406,87	FKMP225FSEFP	3.298,57
250*	FKMP280FDEP	6.271,82	FKMP280FSEP	8.183,34	FKMP280FDEFPP	6.571,58	FKMP280FSEFP	8.483,11
280*	FKMP280FDEP	6.271,82	FKMP280FSEP	8.183,34	FKMP280FDEFPP	6.571,58	FKMP280FSEFP	8.483,11
315*	FKMP315FDEP	6.729,69	FKMP315FSEP	8.641,21	FKMP315FDEFPP	7.029,44	FKMP315FSEFP	8.940,96
355	FKMP355FDEP	Consultar	FKMP355FSEP	Consultar				
400	FKMP400FDEP	Consultar	FKMP400FSEP	Consultar				

Válvula de mariposa motorizada
cuerpo en PPGR y disco en PP-H.
Actuación neumática.

Las válvulas neumáticas se configuran NC (normalmente cerrada) de serie.
La configuración NA (normalmente abierta) se debe especificar en el pedido
* Actuadores de aluminio.



INDUSTRIA

Sistema PP-H Socket

Válvulas de membrana actuadas



DK/CP NC				VM/CP NC				L	
d	Modelo	DN	Ref. EPDM	€ EPDM	Ref. FKM	€ FKM	Ref. PTFE	€ PTFE	
20	DKDM/CP NC	15	DKDMNC020E	289,87	DKDMNC020F	335,63	DKDMNC020P	355,67	
25	DKDM/CP NC	20	DKDMNC025E	307,03	DKDMNC025F	353,76	DKDMNC025P	371,88	
32	DKDM/CP NC	25	DKDMNC032E	373,62	DKDMNC032F	429,70	DKDMNC032P	452,09	
40	DKDM/CP NC	32	DKDMNC040E	492,53	DKDMNC040F	583,40	DKDMNC040P	607,90	
50	DKDM/CP NC	40	DKDMNC050E	557,02	DKDMNC050F	659,03	DKDMNC050P	685,73	
63	DKDM/CP NC	50	DKDMNC063E	773,06	DKDMNC063F	967,66	DKDMNC063P	939,33	
75	DKDM/CP NC	65	DKDMNC075E	863,02	DKDMNC075F	1.161,21	DKDMNC075P	1.127,20	
90	VMDM/CP NC	80	VMDMNC090E	1.403,41	VMDMNC090F	1.851,00	VMDMNC090P	1.612,04	
110	VMDM/CP NC	100	VMDMNC110E	1.744,83	VMDMNC110F	2.173,76	VMDMNC110P	1.941,78	

Válvula neumática **NORMALMENTE CERRADA.**

M-M para soldar socket.

DK/CP NO				VM/CP NO				L	
d	Modelo	DN	Ref. EPDM	€ EPDM	Ref. FKM	€ FKM	Ref. PTFE	€ PTFE	
20	DKDM/CP NO	15	DKDMNO020E	241,76	DKDMNO020F	287,55	DKDMNO020P	307,57	
25	DKDM/CP NO	20	DKDMNO025E	258,93	DKDMNO025F	305,68	DKDMNO025P	323,81	
32	DKDM/CP NO	25	DKDMNO032E	323,58	DKDMNO032F	407,70	DKDMNO032P	432,71	
40	DKDM/CP NO	32	DKDMNO040E	342,89	DKDMNO040F	464,38	DKDMNO040P	496,23	
50	DKDM/CP NO	40	DKDMNO050E	400,66	DKDMNO050F	532,13	DKDMNO050P	568,11	
63	DKDM/CP NO	50	DKDMNO063E	513,33	DKDMNO063F	732,43	DKDMNO063P	726,22	
75	DKDM/CP NO	65	DKDMNO075E	615,98	DKDMNO075F	878,94	DKDMNO075P	871,46	
90	VMDM/CP NO	80	VMDMNO090E	973,25	VMDMNO090F	1.495,35	VMDMNO090P	1.216,54	
110	VMDM/CP NO	100	VMDMNO110E	1.384,62	VMDMNO110F	1.949,06	VMDMNO110P	1.465,30	

Válvula neumática **NORMALMENTE ABIERTA.**

M-M para soldar socket.

DK/CP DE				VM/CP DE				L	
d	Modelo	DN	Ref. EPDM	€ EPDM	Ref. FKM	€ FKM	Ref. PTFE	€ PTFE	
20	DKDM/CP DE	15	DKDMA020E	193,69	DKDMA020F	239,44	DKDMA020P	259,48	
25	DKDM/CP DE	20	DKDMA025E	210,84	DKDMA025F	257,58	DKDMA025P	275,69	
32	DKDM/CP DE	25	DKDMA032E	283,94	DKDMA032F	362,56	DKDMA032P	386,08	
40	DKDM/CP DE	32	DKDMA040E	311,71	DKDMA040F	422,16	DKDMA040P	451,12	
50	DKDM/CP DE	40	DKDMA050E	337,25	DKDMA050F	447,90	DKDMA050P	478,22	
63	DKDM/CP DE	50	DKDMA063E	432,10	DKDMA063F	616,53	DKDMA063P	611,30	
75	DKDM/CP DE	65	DKDMA075E	518,51	DKDMA075F	782,65	DKDMA075P	733,56	
90	VMDM/CP DE	80	VMDMA090E	1.194,66	VMDMA090F	1.716,78	VMDMA090P	1.437,94	
110	VMDM/CP DE	100	VMDMA110E	1.597,19	VMDMA110F	2.005,12	VMDMA110P	1.732,05	

Válvula neumática **DOBLE EFECTO.**

M-M para soldar socket.

DK/CP NC

d	Modelo	DN	Ref. EPDM	€ EPDM	Ref. FKM	€ FKM	Ref. PTFE	€ PTFE
20	DKUIM/CP NC	15	DKUIMNC020E	303,22	DKUIMNC020F	349,98	DKUIMNC020P	370,02
25	DKUIM/CP NC	20	DKUIMNC025E	321,35	DKUIMNC025F	349,98	DKUIMNC025P	386,20
32	DKUIM/CP NC	25	DKUIMNC032E	391,53	DKUIMNC032F	447,64	DKUIMNC032P	470,09
40	DKUIM/CP NC	32	DKUIMNC040E	511,59	DKUIMNC040F	602,44	DKUIMNC040P	628,24
50	DKUIM/CP NC	40	DKUIMNC050E	577,68	DKUIMNC050F	679,63	DKUIMNC050P	706,34
63	DKUIM/CP NC	50	DKUIMNC063E	803,42	DKUIMNC063F	974,52	DKUIMNC063P	969,66

 Válvula neumática **NORMALMENTE CERRADA.**

Con enlaces H-H para encolar.

DK/CP NO

d	Modelo	DN	Ref. EPDM	€ EPDM	Ref. FKM	€ FKM	Ref. PTFE	€ PTFE
20	DKUIM/CP NO	15	DKUIMNO020E	255,14	DKUIMNO020F	301,88	DKUIMNO020P	321,92
25	DKUIM/CP NO	20	DKUIMNO025E	273,28	DKUIMNO025F	301,88	DKUIMNO025P	338,10
32	DKUIM/CP NO	25	DKUIMNO032E	343,05	DKUIMNO032F	418,09	DKUIMNO032P	381,92
40	DKUIM/CP NO	32	DKUIMNO040E	367,48	DKUIMNO040F	488,98	DKUIMNO040P	520,78
50	DKUIM/CP NO	40	DKUIMNO050E	427,24	DKUIMNO050F	558,76	DKUIMNO050P	594,69
63	DKUIM/CP NO	50	DKUIMNO063E	554,04	DKUIMNO063F	771,55	DKUIMNO063P	766,86

 Válvula neumática **NORMALMENTE ABIERTA.**

Con enlaces H-H para soldar socket.

DK/CP DE

d	Modelo	DN	Ref. EPDM	€ EPDM	Ref. FKM	€ FKM	Ref. PTFE	€ PTFE
20	DKUIM/CP DE	15	DKUIMDA020E	207,04	DKUIMDA020F	253,78	DKUIMDA020P	273,80
25	DKUIM/CP DE	20	DKUIMDA025E	225,17	DKUIMDA025F	253,78	DKUIMDA025P	290,01
32	DKUIM/CP DE	25	DKUIMDA032E	302,29	DKUIMDA032F	371,80	DKUIMDA032P	404,41
40	DKUIM/CP DE	32	DKUIMDA040E	334,07	DKUIMDA040F	444,51	DKUIMDA040P	473,44
50	DKUIM/CP DE	40	DKUIMDA050E	359,61	DKUIMDA050F	470,33	DKUIMDA050P	500,58
63	DKUIM/CP DE	50	DKUIMDA063E	466,35	DKUIMDA063F	649,46	DKUIMDA063P	645,51

 Válvula neumática **DOBLE EFECTO.**

Con enlaces H-H para soldar socket.



INDUSTRIA

Sistema PP-H Socket

Válvulas de membrana actuadas



DK/CP NC					VM/CP NC				L
d	Modelo	DN	Ref. EPDM	€ EPDM	Ref. FKM	€ FKM	Ref. PTFE	€ PTFE	
20	DKOM/CP NC	15	DKOMNC020E	333,35	DKOMNC020F	379,11	DKOMNC020P	399,16	
25	DKOM/CP NC	20	DKOMNC025E	353,11	DKOMNC025F	399,81	DKOMNC025P	417,93	
32	DKOM/CP NC	25	DKOMNC032E	429,60	DKOMNC032F	485,69	DKOMNC032P	470,50	
40	DKOM/CP NC	32	DKOMNC040E	566,36	DKOMNC040F	657,25	DKOMNC040P	631,29	
50	DKOM/CP NC	40	DKOMNC050E	640,57	DKOMNC050F	742,58	DKOMNC050P	769,26	
63	DKOM/CP NC	50	DKOMNC063E	889,04	DKOMNC063F	1.083,65	DKOMNC063P	1.055,31	
75	DKOM/CP NC	65	DKOMNC075E	1.066,87	DKOMNC075F	1.300,38	DKOMNC075P	1.266,37	
90	VMOM/CP NC	80	VMOMNC090E	1.613,91	VMOMNC090F	2.061,50	VMOMNC090P	1.822,57	
110	VMOM/CP NC	100	VMOMNC110E	2.006,55	VMOMNC110F	2.434,77	VMOMNC110P	2.203,25	

Válvula neumática **NORMALMENTE CERRADA**.
Con bridas DIN.

Disponibles con bridas ANSI 150 libras al mismo precio

DK/CP NO					VM/CP NO				L
d	Modelo	DN	Ref. EPDM	€ EPDM	Ref. FKM	€ FKM	Ref. PTFE	€ PTFE	
20	DKOM/CP NO	15	DKOMNO020E	285,24	DKOMNO020F	331,03	DKOMNO020P	351,06	
25	DKOM/CP NO	20	DKOMNO025E	305,00	DKOMNO025F	351,73	DKOMNO025P	369,83	
32	DKOM/CP NO	25	DKOMNO032E	387,26	DKOMNO032F	471,36	DKOMNO032P	420,41	
40	DKOM/CP NO	32	DKOMNO040E	424,15	DKOMNO040F	545,65	DKOMNO040P	577,49	
50	DKOM/CP NO	40	DKOMNO050E	492,56	DKOMNO050F	624,03	DKOMNO050P	660,02	
63	DKOM/CP NO	50	DKOMNO063E	640,87	DKOMNO063F	860,01	DKOMNO063P	853,79	
75	DKOM/CP NO	65	DKOMNO075E	769,04	DKOMNO075F	1.032,02	DKOMNO075P	1.024,54	
90	VMOM/CP NO	80	VMOMNO090E	1.183,75	VMOMNO090F	1.705,82	VMOMNO090P	1.427,04	
110	VMOM/CP NO	100	VMOMNO110E	1.576,04	VMOMNO110F	2.014,70	VMOMNO110P	1.725,07	

Válvula neumática **NORMALMENTE ABIERTA**.
Con bridas DIN.

Disponibles con bridas ANSI 150 libras al mismo precio

DK/CP DE					VM/CP DE				L
d	Modelo	DN	Ref. EPDM	€ EPDM	Ref. FKM	€ FKM	Ref. PTFE	€ PTFE	
20	DKOM/CP DE	15	DKOMDA020E	237,15	DKOMDA020F	282,94	DKOMDA020P	302,96	
25	DKOM/CP DE	20	DKOMDA025E	256,90	DKOMDA025F	303,63	DKOMDA025P	321,74	
32	DKOM/CP DE	25	DKOMDA032E	343,92	DKOMDA032F	422,54	DKOMDA032P	382,19	
40	DKOM/CP DE	32	DKOMDA040E	385,61	DKOMDA040F	496,05	DKOMDA040P	524,99	
50	DKOM/CP DE	40	DKOMDA050E	414,60	DKOMDA050F	525,28	DKOMDA050P	555,57	
63	DKOM/CP DE	50	DKOMDA063E	539,45	DKOMDA063F	723,92	DKOMDA063P	718,66	
75	DKOM/CP DE	65	DKOMDA075E	647,35	DKOMDA075F	868,70	DKOMDA075P	862,41	
90	VMOM/CP DE	80	VMOMDA090E	1.405,18	VMOMDA090F	1.927,27	VMOMDA090P	1.648,48	
110	VMOM/CP DE	100	VMOMDA110E	1.788,63	VMOMDA110F	2.276,22	VMOMDA110P	1.992,77	

Válvula neumática **DOBLE EFECTO**.
Con bridas DIN.

Disponibles con bridas ANSI 150 libras al mismo precio

CMDM/CP NC *M-M para fusión socket*
CMIM/CP NC *H-H para fusión socket*
CMUIM/CP NC *H-H enlaces fusión socket*
CMFM/CP NC *H-H rosca*



L

d-Rh	Ref. EPDM	DN	€ EPDM	€ FKM	€ PTFE
20	CMDMNC020E	15	132,37	175,04	197,43
16	CMIMNC016E	12	126,76	148,10	159,32
20	CMIMNC020E	15	126,76	148,10	159,32
20-1/2"	CMUIMNC020E	15	186,21	210,88 (A)	222,11
3/8"	CMFMNC038E	12	126,76	148,10	159,32
1/2"	CMFMNC012E	15	126,76	148,10	159,32

Válvula de membrana compacta neumática
NORMALMENTE CERRADA

Código en FKM termina en "F" en lugar de "E"
 Código en PTFE termina en "P" en lugar de "E"
 (A) = Juntas en FKM

CMDM/CP NO *M-M para fusión socket*
CMIM/CP NO *H-H para fusión socket*
CMUIM/CP NO *H-H enlaces fusión socket*
CMFM/CP NO *H-H rosca*



L

d-Rh	Ref. EPDM	DN	€ EPDM	€ FKM	€ PTFE
20	CMDMNO020E	15	131,25	171,64	195,20
16	CMIMNO016E	12	125,64	145,84	157,05
20	CMIMNO020E	15	125,64	145,84	157,05
20-1/2"	CMUIMNO020E	15	183,99	207,51	219,86
3/8"	CMFMNO038E	12	125,64	145,84	157,05
1/2"	CMFMNO012E	15	125,64	145,84	157,05

Válvula de membrana compacta neumática
NORMALMENTE ABIERTA

Código en FKM termina en "F" en lugar de "E"
 Código en PTFE termina en "P" en lugar de "E"
 (A) = Juntas en FKM

CMDM/CP DE *M-M para fusión socket*
CMIM/CP DE *H-H para fusión socket*
CMUIM/CP DE *H-H enlaces fusión socket*
CMFM/CP DE *H-H rosca*



L

d-Rh	Ref. EPDM	DN	€ EPDM	€ FKM	€ PTFE
20	CMDMDA020E	15	131,25	171,64	195,20
16	CMIMDA016E	12	125,64	145,84	157,05
20	CMIMDA020E	15	125,64	145,84	157,05
20-1/2"	CMUIMDA020E	15	183,99	207,51 (A)	219,86
3/8"	CMFMDA038E	12	125,64	145,84	157,05
1/2"	CMFMDA012E	15	125,64	145,84	157,05

Válvula de membrana compacta neumática
DOBLE EFECTO

Código en FKM termina en "F" en lugar de "E"
 Código en PTFE termina en "P" en lugar de "E"
 (A) = Juntas en FKM

**DKBDM/CP NC**

L

d	Ref. EPDM	DN	PN	€ EPDM
20	DKBDMNC020E	15	6	249,71
25	DKBDMNC025E	20	6	264,48
32	DKBDMNC032E	25	6	353,11
40	DKBDMNC040E	32	6	439,67
50	DKBDMNC050E	40	6	459,73
63	DKBDMNC063E	50	6	637,97
75	DKBDMNC075E	65	6	765,56

Válvula de membrana neumática
Normalmente Cerrada.
M-M soldar socket.

Actuador a pistón

**DKBUIM/CP NC**

L

d	Ref. EPDM	DN	PN	€ EPDM
20	DKBUIMNC020E	15	6	261,21
25	DKBUIMNC025E	20	6	276,85
32	DKBUIMNC032E	25	6	370,13
40	DKBUIMNC040E	32	6	456,67
50	DKBUIMNC050E	40	6	476,72
63	DKBUIMNC063E	50	6	663,04

Válvula de membrana neumática
Normalmente Cerrada.
Con enlaces H-H para soldar socket.

Actuador a pistón

**DKBOM/CP NC**

L

d	Ref. EPDM	DN	PN	€ EPDM
20	DKBOMNC020E	15	6	287,15
25	DKBOMNC025E	20	6	304,18
32	DKBOMNC032E	25	6	413,76
40	DKBOMNC040E	32	6	519,60
50	DKBOMNC050E	40	6	543,26
63	DKBOMNC063E	50	6	753,92
75	DKBOMNC075E	65	6	980,12

Válvula de membrana neumática
Normalmente Cerrada.
Con bridas DIN.

Actuador a pistón

**DKBOAM/CP NC**

L

d	Ref. EPDM	DN	PN	€ EPDM
1/2"	DKBOAMNC012E	15	6	287,15
3/4"	DKBOAMNC034E	20	6	304,18
1"	DKBOAMNC100E	25	6	413,76
1 1/4"	DKBOAMNC114E	32	6	519,60
1 1/2"	DKBOAMNC112E	40	6	543,26
2"	DKBOAMNC200E	50	6	749,31
2 1/2"	DKBOAMNC212E	65	6	907,51

Válvula de membrana neumática
Normalmente Cerrada.
Con bridas ANSI 150 lbs.

Actuador a pistón



INDUSTRIA

Sistema PP-H Socket

Válvulas de control de presión



VSF

L

d	Ref. EPDM	DN	PN	€	
				EPDM	PTFE
16	VSFBM016E	10	10	360,48	408,94
20	VSFBM020E	15	10	424,49	436,52
25	VSFBM025E	20	10	467,97	500,23
32	VSFBM032E	25	10	495,23	522,87
40	VSFBM040E	32	10	625,02	668,47
50	VSFBM050E	40	10	1.041,10	1.087,98
63	VSFBM063E	50	10	1.398,24	1.412,59

Válvula de sobrepresión-alivio.
M-M para soldadura a testa.

Código en PTFE termina en "P"
en lugar de "E"
Rango de calibración: 0,5 - 10 bars



VCP

L

d	Ref. EPDM	DN	PN	€	
				EPDM	PTFE
16	VCPBM016E	10	10	329,11	356,94
20	VCPBM020E	15	10	329,11	356,94
25	VCPBM025E	20	10	440,03	471,17
32	VCPBM032E	25	10	472,67	510,78
40	VCPBM040E	32	10	602,68	633,79
50	VCPBM050E	40	10	930,06	964,21
63	VCPBM063E	50	10	1.216,81	1.244,69

Válvula retenedora de presión.
M-M para soldadura a testa.

Código en PTFE termina en "P"
en lugar de "E"
Rango de calibración: 0,5 - 10 bars



VPR

L

d	Ref.	DN	PN	€	
				EPDM	FKM
16	VPRBM016E	10	10	919,19	952,93
20	VPRBM020E	15	10	919,19	952,93
25	VPRBM025E	20	10	1.173,12	1.224,48
32	VPRBM032E	25	10	1.173,12	1.224,48
40	VPRBM040E	32	10	1.412,34	1.476,02
50	VPRBM050E	40	10	1.412,34	1.476,02
63	VPRBM063E	50	10	1.997,16	2.059,64

Válvula reductora de presión.
M-M para soldadura a testa.

Código en FKM termina en "F"
en lugar de "E"
Rango de calibración: 0,5 - 9 bars



INDUSTRIA

Sistema PP-H Socket Conectores



MANGUITO



V

d	Ref. EPDM	Para válvulas	€
16	ENDIM016	VKD-VKR-TKD-SR-RV-VR	12,05
20	ENDIM020	VKD-VKR-TKD-SR-RV-VR	12,05
25	ENDIM025	VKD-VKR-TKD-SR-RV-VR	14,32
32	ENDIM032	VKD-VKR-TKD-SR-RV-VR	15,83
40	ENDIM040	VKD-VKR-TKD-SR-RV-VR	19,56
50	ENDIM050	VKD-VKR-TKD-SR-RV-VR	22,50
63	ENDIM063	VKD-VKR-TKD-SR-RV-VR	28,51
75	ENDIM075	VKD	67,54
90	ENDIM090	VKD	73,72
110	ENDIM110	VKD	102,37

Conector final en PP-H.
H para soldar socket.

MANGUITO



V

Rh	Ref. EPDM	Para válvulas	€
3/8"	ENDFM038	VKD-VKR-TKD-SR-RV-VR	12,05
1/2"	ENDFM012	VKD-VKR-TKD-SR-RV-VR	12,05
3/4"	ENDFM034	VKD-VKR-TKD-SR-RV-VR	14,32
1"	ENDFM100	VKD-VKR-TKD-SR-RV-VR	15,83
1 1/4"	ENDFM114	VKD-VKR-TKD-SR-RV-VR	19,56
1 1/2"	ENDFM112	VKD-VKR-TKD-SR-RV-VR	22,50
2"	ENDFM200	VKD-VKR-TKD-SR-RV-VR	28,51

Conector final en PP-H.
H rosca gas.

MANGUITO



V

Rh	Ref. EPDM	Para válvulas	€
1/2"	ENDNM012	VKD-VKR-TKD-SR-RV-VR	12,05
3/4"	ENDNM034	VKD-VKR-TKD-SR-RV-VR	14,32
1"	ENDNM100	VKD-VKR-TKD-SR-RV-VR	15,83
1 1/4"	ENDNM114	VKD-VKR-TKD-SR-RV-VR	19,56
1 1/2"	ENDNM112	VKD-VKR-TKD-SR-RV-VR	22,50
2"	ENDNM200	VKD-VKR-TKD-SR-RV-VR	28,51

Conector final en PP-H.
H rosca NPT.

MANGUITO



V

d	Ref. EPDM	Para válvulas	€
20	ENDDM020	VKD-VKR-TKD-SR-RV-VR	12,05
25	ENDDM025	VKD-VKR-TKD-SR-RV-VR	14,32
32	ENDDM032	VKD-VKR-TKD-SR-RV-VR	15,83
40	ENDDM040	VKD-VKR-TKD-SR-RV-VR	19,56
50	ENDDM050	VKD-VKR-TKD-SR-RV-VR	22,50
63	ENDDM063	VKD-VKR-TKD-SR-RV-VR	28,51
75	ENDDM075	VKD	67,54
90	ENDDM090	VKD	73,72
110	ENDDM110	VKD	102,37

Conector final en PP-H.
M para soldar socket.

Q-BBM/L



V

d	Ref. EPDM	Para válvulas	€
20	QBBML11020	CM-DK	5,68
25	QBBML11025	CM-DK	6,85
32	QBBML11032	CM-DK	8,41
40	QBBML11040	CM-DK	10,92
50	QBBML11050	CM-DK	11,53
63	QBBML11063	CM-DK	16,60

Conector final en PP SDR11.
Para soldar a testa o electrofusión.

CVDM



V

d	Ref. EPDM	Para válvulas	€
20	CVDM11020	VKD-VKR-TKD-SR-RV-VR	5,69
25	CVDM11025	VKD-VKR-TKD-SR-RV-VR	6,67
32	CVDM11032	VKD-VKR-TKD-SR-RV-VR	8,20
40	CVDM11040	VKD-VKR-TKD-SR-RV-VR	10,21
50	CVDM11050	VKD-VKR-TKD-SR-RV-VR	13,25
63	CVDM11063	VKD-VKR-TKD-SR-RV-VR	17,05
75	CVDM11075	VKD	34,49
90	CVDM11090	VKD	43,35
110	CVDM11110	VKD	52,52

Conector final en PP-H SDR11.
Para soldar a testa o electrofusión.

Accesorios

Sistema PP-H testa / butt welding

INDUSTRIA





Sistema PP-H Testa





INDUSTRIA

Sistema PP-H testa / butt welding

Codos / Tapones



GBM

T1

d	Ref. PN6	€ PN6 SDR 17,6	Ref. PN10	€ PN10 SDR 11
20			GBM11020	4,20
25			GBM11025	4,37
32			GBM11032	4,52
40			GBM11040	5,87
50	GBM17050	7,04	GBM11050	7,39
63	GBM17063	9,74	GBM11063	10,57
75	GBM17075	14,27	GBM11075	14,56
90	GBM17090	18,63	GBM11090	21,18
110	GBM17110	39,21	GBM11110	40,28
125	GBM17125	49,88	GBM11125	56,75
140	GBM17140	72,44	GBM11140	75,85
160	GBM17160	77,67	GBM11160	92,42
180	GBM17180	98,76	GBM11180	109,42
200	GBM17200	122,30	GBM11200	163,07
225	GBM17225	150,75	GBM11225	194,49
250	GBM17250	254,58	GBM11250	374,42
280	GBM17280	330,85	GBM11280	486,82
315	GBM17315	457,08	GBM11315	672,08
355	GBM17355	1.037,27	GBM11355	1.407,80
400	GBM17400	1.444,39	GBM11400	1.933,28
450	GBM17450	1.861,24	GBM11450	2.500,56
500	GBM17500	2.348,63	GBM11500	3.225,72

Codo 90°.

M-M para soldar a testa.



HBM

T1

d	Ref. PN6	€ PN6 SDR 17,6	Ref. PN10	€ PN10 SDR 11
20			HBM11020	3,95
25			HBM11025	4,11
32			HBM11032	4,27
40			HBM11040	5,52
50	HBM17050	5,53	HBM11050	6,94
63	HBM17063	9,20	HBM11063	9,97
75	HBM17075	13,44	HBM11075	13,75
90	HBM17090	17,56	HBM11090	19,90
110	HBM17110	36,96	HBM11110	37,91
125	HBM17125	46,96	HBM11125	53,41
140	HBM17140	68,21	HBM11140	71,41
160	HBM17160	75,22	HBM11160	87,01
180	HBM17180	121,00	HBM11180	134,59
200	HBM17200	165,53	HBM11200	183,93
225	HBM17225	197,49	HBM11225	219,26
250	HBM17250	382,16	HBM11250	424,65
280	HBM17280	577,09	HBM11280	641,21
315	HBM17315	718,16	HBM11315	802,25

Codo 45°.

M-M para soldar a testa.



CBM

T1

d	Ref. PN6	€ PN6 SDR 17,6	Ref. PN10	€ PN10 SDR 11
20			CBM11020	5,45
25			CBM11025	5,98
32			CBM11032	7,55
40			CBM11040	9,40
50			CBM11050	12,25
63	CBM17063	16,17	CBM11063	16,17
75	CBM17075	25,02	CBM11075	25,02
90	CBM17090	38,00	CBM11090	38,00
110	CBM17110	51,51	CBM11110	51,51
125	CBM17125	64,25	CBM11125	55,66
140	CBM17140	69,62	CBM11140	69,62
160	CBM17160	78,04	CBM11160	78,04
180	CBM17180	101,45	CBM11180	101,45

Tapón.

M para soldar a testa.

d	Ref. PN6	€ PN6 SDR 17,6	Ref. PN10	€ PN10 SDR 11
200	CBM17200	126,35	CBM11200	126,35
225	CBM17225	150,83	CBM11225	150,83
250	CBM17250	192,31	CBM11250	192,31
280	CBM17280	272,51	CBM11280	272,51
315	CBM17315	363,90	CBM11315	363,90
355	CBM17355	470,44	CBM11355	400,46
400	CBM17400	582,39	CBM11400	548,99
450	CBM17450	801,87	CBM11450	830,31
500	CBM17500	960,06	CBM11500	1.055,83
560	CBM17560	1.224,05		
630	CBM17630	1.857,06		
710	CBM17710	2.802,93		
800	CBM17800	4.394,40		

**QBM**

T1

d	Ref. PN6	€ PN6 SDR 17,6	Ref. PN10	€ PN10 SDR 11
20			QBM11020	3,80
25			QBM11025	3,80
32			QBM11032	4,49
40	QBM17040	5,17	QBM11040	5,38
50	QBM17050	6,07	QBM11050	6,58
63	QBM17063	7,39	QBM11063	8,22
75	QBM17075	8,71	QBM11075	9,74
90	QBM17090	12,78	QBM11090	13,96
110	QBM17110	16,25	QBM11110	17,97
125	QBM17125	19,95	QBM11125	21,65
140	QBM17140	23,21	QBM11140	25,29
160	QBM17160	28,69	QBM11160	31,90
180	QBM17180	41,90	QBM11180	49,51
200	QBM17200	52,39	QBM11200	54,46
225	QBM17225	58,70	QBM11225	60,70
250	QBM17250	83,89	QBM11250	92,15
280	QBM17280	92,15	QBM11280	100,67
315	QBM17315	112,51	QBM11315	118,61
355	QBM17355	276,19	QBM11355	301,62
400	QBM17400	558,13	QBM11400	594,14
450	QBM17450	648,30	QBM11450	685,97
500	QBM17500	799,23	QBM11500	868,69
560	QBM17560	956,67	QBM11560	1.126,98
630	QBM17630	1.107,95	QBM11630	1.342,45
710	QBM17710	1.627,19		
800	QBM17800	2.359,76		
900	QBM17900	4.334,93		
1.000	QBM171000	7.106,92		

Manguito portabridas.

M para soldar a testa.

**TBM**

T1

d	Ref. PN6	€ PN6 SDR 17,6	Ref. PN10	€ PN10 SDR 11
20			TBM11020	3,35
25			TBM11025	3,35
32			TBM11032	4,22
40			TBM11040	6,72
50	TBM17050	10,66	TBM11050	9,10
63	TBM17063	10,92	TBM11063	14,07
75	TBM17075	22,31	TBM11075	28,33
90	TBM17090	31,85	TBM11090	42,32
110	TBM17110	52,86	TBM11110	62,15
125	TBM17125	73,26	TBM11125	85,58
140	TBM17140	86,46	TBM11140	108,43
160	TBM17160	162,58	TBM11160	182,41
180	TBM17180	199,69	TBM11180	233,79
200	TBM17200	272,72	TBM11200	334,98
225	TBM17225	320,15	TBM11225	398,48
250	TBM17250	424,92	TBM11250	506,93
280	TBM17280	480,26	TBM11280	685,38
315	TBM17315	638,76	TBM11315	973,62
355	TBM17355	1.375,51	TBM11355	1.629,50
400	TBM17400	1.880,04	TBM11400	2.433,10
450	TBM17450	2.577,11	TBM11450	3.168,62
500	TBM17500	3.316,48	TBM11500	4.049,64

Te 90°.

M-M-M para soldar a testa.



TRBM

T1

d x dr	Ref. PN6	€ PN6 SDR 17,6	Ref. PN10	€ PN10 SDR 11	d x dr	Ref. PN6	€ PN6 SDR 17,6	Ref. PN10	€ PN10 SDR 11
63 x 50*	TRBM17063050	26,25	TRBM11063050	28,37	180 x 63	TRBM17180063	266,01	TRBM11180063	311,01
75 x 32*			TRBM11075032	44,44	180 x 75	TRBM17180075	266,01	TRBM11180075	311,01
75 x 50*	TRBM17075050	39,76	TRBM11075050	44,44	180 x 90*	TRBM17180090	321,08	TRBM11180090	355,77
75 x 63*	TRBM17075063	40,44	TRBM11075063	45,29	180 x 110*	TRBM17180110	274,13	TRBM11180110	355,77
90 x 32			TRBM11090032	56,19	180 x 125	TRBM17180125	274,13	TRBM11180125	320,99
90 x 50			TRBM11090050	57,73	180 x 160*	TRBM17180160	321,08	TRBM11180160	355,77
90 x 63*	TRBM17090063	56,57	TRBM11090063	63,28	200 x 63*	TRBM17200063	362,98	TRBM11200063	445,97
90 x 75*	TRBM17090075	57,06	TRBM11090075	63,80	200 x 90*	TRBM17200090	367,06	TRBM11200090	450,71
110 x 32			TRBM11110032	82,91	200 x 110*	TRBM17200110	371,10	TRBM11200110	455,34
110 x 50			TRBM11110050	84,63	200 x 125*	TRBM17200125	374,86	TRBM11200125	460,39
110 x 63*	TRBM17110063	83,89	TRBM11110063	93,86	200 x 160*	TRBM17200160	379,58	TRBM11200160	465,39
110 x 75*	TRBM17110075	83,89	TRBM11110075	93,86	225 x 75*	TRBM17225075	541,85	TRBM11225075	601,43
110 x 90*	TRBM17110090	85,92	TRBM11110090	95,16	225 x 90*	TRBM17225090	541,85	TRBM11225090	601,43
			TRBM11125063	118,41	225 x 110*	TRBM17225110	543,67	TRBM11225110	603,88
			TRBM11125090	130,55	225 x 125	TRBM17225125	435,89	TRBM11225125	541,50
125 x 110*	TRBM17125110	116,52	TRBM11125110	130,55	225 x 160*	TRBM17225160	545,16	TRBM11225160	606,01
140 x 63	TRBM17140063	115,32	TRBM11140063	148,55	225 x 180*	TRBM17225180	546,11	TRBM11225180	608,09
140 x 75	TRBM17140075	115,86	TRBM11140075	148,55	250 x 110	TRBM17250110	571,84	TRBM11250110	714,68
140 x 90	TRBM17140090	117,73	TRBM11140090	150,92	250 x 160	TRBM17250160	583,47	TRBM11250160	729,41
140 x 110	TRBM17140110	120,15	TRBM11140110	150,92	315 x 110			TRBM11315110	1.614,48
160 x 63*	TRBM17160063	230,92	TRBM11160063	256,67	315 x 225			TRBM11315225	1.687,89
160 x 75*	TRBM17160075	237,99	TRBM11160075	258,82	315 x 250			TRBM11315250	1.687,89
160 x 90*	TRBM17160090	237,99	TRBM11160090	258,82					
160 x 110*	TRBM17160110	240,22	TRBM11160110	258,82					
160 x 125	TRBM17160125	224,04	TRBM11160125	250,49					

Te a 90° reducida.

M-M para soldar a testa.

* Espigots LARGOS

**QBAM FK**

T1

d Vál	d Tubo	Ref. PN6	€ PN6 SDR 17,6	Ref. PN10	€ PN10 SDR 11
50	50	QPM17050	7,62	QPM11050	8,27
63	63	QPM17063	9,28	QPM11063	10,23
75	75	QPM17075	11,01	QPM11075	12,33
90	90	QPM17090	16,07	QPM11090	17,57
110	110	QPM17110	20,42	QPM11110	23,32
140	125	QPM17125	24,96	QPM11125	27,17
160	140	QPM17140	29,02	QPM11140	31,73
160	160	QPM17160	35,98	QPM11160	61,49
160	180	QPM17180	55,70	QPM11180	65,72
225	200	QBM17FK200	100,62	QPM11FK200	104,74
225	225	QPM17225	73,41	QPM11FK225	116,67
280	250	QPM17250	104,98	QPM11FK250	177,10
280	280	QBM17FK280	171,11	QPM11FK280	193,46
315	315	QBM17FK315	216,25	QPM11FK315	227,94
355	350	QBM17FK355	513,18	QPM11FK355	561,33
400	400	QBM17FK400	970,41	QPM11FK400	1.045,21

Manguito portabridas
para válvulas de mariposa FE/FK.

M para soldar a testa.

**QBAM**

T1

d	Ref. PN6	€ PN6 SDR 17,6	Ref. PN10	€ PN10 SDR 11
3/4"			QBAM11034	5,02
1"			QBAM11100	5,94
1 1/4"	QBAM17114	6,82	QBAM11114	7,08
1 1/2"	QBAM17112	8,00	QBAM11112	8,69
3"	QBAM17300	16,90	QBAM11300	18,39

Manguito portabridas largo

ANSI 150 lbs.

M para soldar a testa.

ODB



T1

d	Ref.	DN	PN	€
20	ODB020	15	16	9,84
25	ODB025	20	16	10,82
32	ODB032	25	16	13,95
40	ODB040	32	16	16,91
50	ODB050	40	16	19,77
63	ODB063	50	16	24,58
75	ODB075	65	16	27,17
90	ODB090	80	16	32,36
110	ODB110	100	16	39,05
125	ODB125	100	16	39,05
140	ODB140	125	16	58,39
140	ODB140DN125	*125	16	55,97
160	ODB160	150	16	59,47
180	ODB180	150	16	68,20
200	ODB200	200	10	89,33
225	ODB225	200	10	89,33
225	ODB225DN200	*200	10	114,99
250	ODB250	250	10	111,81
280	ODB280	250	10	113,91
280	ODB280DN250	*250	10	119,07
315	ODB315	300	10	173,93
315	ODB315DN300	*300	10	174,38
355	ODB355	350	10	325,62
400	ODB400	400	10	469,89
450	ODB450	450	10	840,17
500	ODB500	500	10	840,17
560	ODB560	600	10	1.139,37
630	ODB630	600	10	1.139,37

Brida loca PP con alma de acero

DIN 2501 DIN 16962/16963.

* Para portabridas PVC-U

A partir de Ø 75 no utilizar con portabridas socket (sólo testa)

OAB



T1

d	Ref.	DN	€
½"	OAB012	15	12,24
¾"	OAB034	20	15,24
1"	OAB100	25	17,97
1¼"	OAB114	32	20,71
1½"	OAB112	40	25,81
2"	OAB200	50	32,10
2½"	OAB212	65	39,64
3"	OAB300	80	46,48
4"	OAB400	100	60,63
8"	OAB800	200	165,71
10"	OAB810	250	213,41
12"	OAB812	300	329,18
14"	OAB814	350	621,10
16"	OAB816	400	757,32

Brida loca PP con alma de acero
ANSI 150 lbs.

A partir de Ø 75 no utilizar con portabridas socket (sólo testa)

ODBC



T1

d	Ref.	DN	PN	€
20	ODBC020	15	16	75,20
25	ODBC025	20	16	76,37
32	ODBC032	25	16	78,31
40	ODBC040	32	16	83,87
50	ODBC050	40	16	95,01
63	ODBC063	50	16	103,43
75	ODBC075	65	16	121,18
90	ODBC090	80	16	133,35
110/125	ODBC110	100	16	182,19
140	ODBC140	125	16	223,71
160/180	ODBC160	150	16	282,31
200/225	ODBC200	200	10	313,55
250/280	ODBC250	250	10	409,74
315	ODBC315	300	10	598,17
355	ODBC355	350	10	1.170,10
400	ODBC400	400	10	1.336,64

Brida ciega PP con alma de acero DIN 2501

OABC



T1

d	Ref.	DN	€
½"	OABC012	15	87,44
¾"	OABC034	20	88,68
1"	OABC100	25	90,84
1¼"	OABC114	32	97,34
1½"	OABC112	40	110,54
2"	OABC200	50	120,28
2½"	OABC212	65	137,45
3"	OABC300	80	154,96
4"	OABC400	100	211,74
6"	OABC600	150	328,26
8"	OABC800	200	364,53
10"	OABC810	250	476,02
12"	OABC812	300	695,68

Brida ciega PP con alma de acero ANSI 150 lbs.

RBM



T1

d x dr	Ref. PN6	€ PN6 SDR 17,6	Ref. PN10	€ PN10 SDR 11
25 x 20			RBM11025020	5,58
32 x 20			RBM11032020	6,47
32 x 25			RBM11032025	6,47
40 x 20			RBM11040020	7,42
40 x 25			RBM11040025	7,42
40 x 32			RBM11040032	7,42
50 x 25			RBM11050025	7,78
50 x 32	RBM17050032	7,42	RBM11050032	7,78
50 x 40	RBM17050040	7,42	RBM11050040	7,78
63 x 32	RBM17063032	8,93	RBM11063032	9,43
63 x 40	RBM17063040	8,93	RBM11063040	9,43
63 x 50	RBM17063050	8,93	RBM11063050	9,43
75 x 32	RBM17075032	11,53	RBM11075032	12,09
75 x 40	RBM17075040	11,53	RBM11075040	12,09
75 x 50	RBM17075050	11,53	RBM11075050	12,09
75 x 63	RBM17075063	11,53	RBM11075063	12,09
90 x 50	RBM17090050	12,83	RBM11090050	13,41
90 x 63	RBM17090063	12,83	RBM11090063	13,41
90 x 75	RBM17090075	12,83	RBM11090075	13,41
110 x 50	RBM17110050	16,36	RBM11110050	17,11
110 x 63	RBM17110063	16,36	RBM11110063	17,11
110 x 75	RBM17110075	16,36	RBM11110075	17,11
110 x 90	RBM17110090	16,36	RBM11110090	17,11
125 x 63	RBM17125063	20,98	RBM11125063	21,99
125 x 75	RBM17125075	20,98	RBM11125075	21,99
125 x 90	RBM17125090	20,98	RBM11125090	21,99
125 x 110	RBM17125110	20,98	RBM11125110	21,99
140 x 75	RBM17140075	25,44	RBM11140075	26,65
140 x 90	RBM17140090	25,44	RBM11140090	26,65
140 x 110	RBM17140110	25,44	RBM11140110	26,65
140 x 125	RBM17140125	25,44	RBM11140125	26,65
160 x 90	RBM17160090	29,70	RBM11160090	31,26
160 x 110	RBM17160110	29,70	RBM11160110	31,26
160 x 125	RBM17160125	29,70	RBM11160125	31,26
160 x 140	RBM17160140	29,70	RBM11160140	31,26
180 x 90	RBM17180090	46,65	RBM11180090	49,05
180 x 110	RBM17180110	43,94	RBM11180110	46,14
180 x 125	RBM17180125	40,58	RBM11180125	42,57
180 x 140	RBM17180140	38,48	RBM11180140	40,42
180 x 160	RBM17180160	36,69	RBM11180160	38,56
200 x 140	RBM17200140	105,23	RBM11200140	110,41
200 x 160	RBM17200160	93,05	RBM11200160	97,64
200 x 180	RBM17200180	83,23	RBM11200180	87,44

Reducción concéntrica.

M-M para soldar a testa.

d x dr	Ref. PN6	€ PN6 SDR 17,6	Ref. PN10	€ PN10 SDR 11
225 x 140	RBM17225140	125,61	RBM11225140	131,92
225 x 160	RBM17225160	107,78	RBM11225160	113,17
225 x 180	RBM17225180	102,68	RBM11225180	107,75
225 x 200	RBM17225200	90,42	RBM11225200	94,95
250 x 160	RBM17250160	143,99	RBM11250160	151,13
250 x 180	RBM17250180	133,15	RBM11250180	139,82
250 x 200	RBM17250200	122,57	RBM11250200	128,67
250 x 225	RBM17250225	116,21	RBM11250225	121,91
280 x 200	RBM17280200	160,28	RBM11280200	168,38
280 x 225	RBM17280225	149,46	RBM11280225	156,97
280 x 250	RBM17280250	145,53	RBM11280250	151,13
315 x 200	RBM17315200	204,61	RBM11315200	214,84
315 x 225	RBM17315225	180,99	RBM11315225	190,10
315 x 250	RBM17315250	164,93	RBM11315250	173,13
315 x 280	RBM17315280	154,46	RBM11315280	162,23
355 x 200	RBM17355200	386,07	RBM11355200	405,31
355 x 225	RBM17355225	371,16	RBM11355225	389,67
355 x 250	RBM17355250	356,06	RBM11355250	373,80
355 x 280	RBM17355280	330,31	RBM11355280	346,85
355 x 315	RBM17355315	320,31	RBM11355315	336,31
400 x 225	RBM17400225	1.625,96	RBM11400225	1.732,15
400 x 250	RBM17400250	1.412,48	RBM11400250	1.588,79
400 x 280	RBM17400280	1.252,71	RBM11400280	1.253,02
400 x 315	RBM17400315	970,47	RBM11400315	970,47
400 x 355	RBM17400355	656,47	RBM11400355	663,50
450 x 280	RBM17450280	1.765,92	RBM11450280	1.765,92
450 x 315	RBM17450315	1.573,70	RBM11450315	1.573,70
450 x 355	RBM17450355	1.191,78	RBM11450355	1.191,78
450 x 400	RBM17450400	880,38	RBM11450400	880,38
500 x 280	RBM17500280	2.789,39	RBM11500280	2.869,16
500 x 315	RBM17500315	2.079,31	RBM11500315	2.137,19
500 x 355	RBM17500355	1.835,50	RBM11500355	1.968,26
500 x 400	RBM17500400	1.581,87	RBM11500400	1.726,70
500 x 450	RBM17500450	1.436,98	RBM11500450	1.557,79
560 x 355	RBM17560355	3.041,98	RBM11560355	3.206,49
560 x 400	RBM17560400	2.547,84	RBM11560400	2.946,43
560 x 450	RBM17560450	1.678,43	RBM11560450	1.750,97
560 x 500	RBM17560500	1.328,21	RBM11560500	1.424,81
630 x 355	RBM17630355	4.093,51		
630 x 400	RBM17630400	3.501,80		
630 x 450	RBM17630450	2.922,27		
630 x 500	RBM17630500	2.801,45		
630 x 560	RBM17630560	1.799,27		
710 x 500	RBM17710500	2.162,48		
710 x 560	RBM17710560	1.808,71		
710 x 630	RBM17710630	1.494,83		
800 x 560	RBM17800560	2.681,81		
800 x 630	RBM17800630	2.261,90		
800 x 710	RBM17800710	1.903,98		

DBMM



T1

d x Rh	Ref.	€ PN10 SDR 11
20 x 1/2"	DBMM11020012	11,16
25 x 3/4"	DBMM11025034	14,39
32 x 1"	DBMM11032100	16,96
40 x 1 1/4"	DBMM11040114	19,86
50 x 1 1/2"	DBMM11050112	24,89
63 x 2"	DBMM11063200	29,45

Terminal rosca hembra largo.

M para soldar a testa o electrofusión - H rosca.

KBFM



T1

d x Rh	Ref.	€ PN10 SDR 11
20 x 1/2"	KBFM11020012	11,21
25 x 3/4"	KBFM11025034	13,44
32 x 1"	KBFM11032100	16,96
40 x 1 1/4"	KBFM11040114	20,42
50 x 1 1/2"	KBFM11050112	33,48
63 x 2"	KBFM11063200	42,25

Terminal rosca macho corto.

M para soldar a testa - M rosca.

BBM/L



T1

d	Ref. EPDM	€ EPDM	Ref. FKM	€ FKM
20	BBML11020E	21,47	BBML11020F	24,02
25	BBML11025E	26,77	BBML11025F	30,10
32	BBML11032E	27,55	BBML11032F	30,45
40	BBML11040E	39,08	BBML11040F	46,10
50	BBML11050E	48,84	BBML11050F	56,45
63	BBML11063E	64,10	BBML11063F	72,86

Unión 3 piezas largo.

SDR 11 (PN10).

M-M para soldar a testa y electrofusión.

BBM/C



T1

d	Ref. EPDM	€ EPDM	Ref. FKM	€ FKM
20	BBMC11020E	21,47	BBMC11020F	24,02
25	BBMC11025E	26,77	BBMC11025F	30,10
32	BBMC11032E	27,55	BBMC11032F	30,45
40	BBMC11040E	39,08	BBMC11040F	46,10
50	BBMC11050E	48,84	BBMC11050F	56,45
63	BBMC11063E	64,10	BBMC11063F	72,86

Unión 3 piezas corto.

SDR 11 (PN10).

M-M para soldar a testa.

Q-BBM/L



T1

d	Ref.	€ SDR 11
20	QBBML11020	5,68
25	QBBML11025	6,85
32	QBBML11032	8,41
40	QBBML11040	10,92
50	QBBML11050	11,53
63	QBBML11063	16,60
75	QBBML11075	23,56
90	QBBML11090	26,30
110	QBBML11110	34,22

Manguito porta tuerca unión 3 piezas largo.

M para soldar a testa y electrofusión.

Q-BBM/C



T1

d	Ref.	€ SDR 11
20	QBBMC11020	5,68
25	QBBMC11025	7,20
32	QBBMC11032	7,20
40	QBBMC11040	12,12
50	QBBMC11050	12,12
63	QBBMC11063	13,30
75	QBBMC11075	18,18
90	QBBMC11090	24,82
110	QBBMC11110	32,26

Manguito porta tuerca unión 3 piezas corto.

M para soldar a testa.

F-BBM/L

T1

d	Ref.	€ SDR 11
20	FBBML11020	9,90
25	FBBML11025	12,38
32	FBBML11032	12,38
40	FBBML11040	18,42
50	FBBML11050	18,42
63	FBBML11063	21,82
75	FBBML11075	27,88
90	FBBML11090	35,72
110	FBBML11110	40,82

Manguito para tuerca unión 3 piezas largo.
SDR 11 (PN10).

M para soldar a testa y electrofusión.

F-BBM/C

T1

d	Ref.	€ SDR 11
20	FBBMC11020	8,59
25	FBBMC11025	10,75
32	FBBMC11032	10,75
40	FBBMC11040	16,00
50	FBBMC11050	16,00
63	FBBMC11063	18,96
75	FBBMC11075	25,86
90	FBBMC11090	33,76
110	FBBMC11110	41,24

Manguito para tuerca unión 3 piezas corto.
SDR 11 (PN10).

M para soldar a testa.

N-BBM

I

d	Ref.	Rh	€ SDR 11
20	EFGM100	1"	7,28
25	EFGM114	1¼"	7,54
32	EFGM112	1½"	8,75
40	EFGM200	2"	11,17
50	EFGM214	2¼"	17,30
63	EFGM234	2¾"	27,89

Tuerca para unión 3 piezas BBM
largo y corto.

H roscar.

O-BBM

I

d	Ref. EPDM	€ EPDM	Ref. FKM	€ FKM
20	OR4081E	5,04	OR4081F	13,34
25	OR4112E	1,81	OR4112F	2,51
32	OR4131E	2,57	OR4131F	7,10
40	OR6162E	2,74	OR6162F	10,47
50	OR6187E	2,91	OR6187F	11,93
63	OR6237E	3,18	OR6237F	13,34

Junta tórica para unión 3 piezas BBM
largo y corto.

Tubo y accesorios
Válvulas manuales
Válvulas actuadas
Válvulas de control de presión

**Sistema
PVDF**

INDUSTRIA





Sistema PVDF





INDUSTRIA

Sistema PVDF

Tubo y accesorios



Consultar precios



Y

d	Ref.	Epesor mm.	€/m
16	PIPEF21016	1,9	
20	PIPEF21020	1,9	
25	PIPEF21025	1,9	
32	PIPEF21032	2,4	
40	PIPEF21040	2,4	
50	PIPEF21050	3,0	
63	PIPEF21063	3,0	
75	PIPEF21075	3,6	
90	PIPEF21090	4,3	
110	PIPEF21110	5,3	

Tubo PVDF ISO 10931-2.
PN16. Barras de 5 m.

Disponible en Pn10
de 63 a 110 mm.
Precios consultar



GIF

Y

d	Ref.	Pack	€
16	GIF016	10	
20	GIF020	10	
25	GIF025	10	
32	GIF032	10	
40	GIF040	5	
50	GIF050	5	
63	GIF063	2	
75	GIF075	2	
90	GIF090	2	
110	GIF110	2	

Codo 90°.
H-H para fusión socket.

HIF



Y

d	Ref.	Pack	€
20	HIF020	10	
25	HIF025	10	
32	HIF032	10	
40	HIF040	5	
50	HIF050	5	
63	HIF063	5	
75	HIF075	2	
90	HIF090	2	
110	HIF110	2	

Codo 45°.
H-H para fusión socket.

TIF



Y

d	Ref.	Pack	€
16	TIF016	10	
20	TIF020	10	
25	TIF025	10	
32	TIF032	10	
40	TIF040	5	
50	TIF050	5	
63	TIF063	5	
75	TIF075	2	
90	TIF090	2	
110	TIF110	2	

Te a 90°.
H-H-H para fusión socket.

CIF



Y

d	Ref.	Pack	€
16*	CIF016	10	
20	CIF020	10	
25	CIF025	10	
32	CIF032	10	
40	CIF040	5	
50	CIF050	5	
63	CIF063	5	
75	CIF075	2	
90	CIF090	2	
110	CIF110	2	

Tapón.
H para fusión socket.

QRNF



Y

d	Ref.	Pack	€
20	QRNF020	10	
25	QRNF025	10	
32	QRNF032	10	
40	QRNF040	5	
50	QRNF050	5	
63	QRNF063	2	
75	QRNF075	2	
90	QRNF090	2	
110	QRNF110	2	

Manguito portabridas.
H para fusión socket.

Consultar precios

QRAF



Y

d	Ref.	Pack	€
¾"	QRAF034	10	
1"	QRAF100	10	
1¼"	QRAF114	5	
1½"	QRAF112	5	
3"	QRAF300	-	

Manguito portabridas **ANSI 150 lbs.**
H para fusión socket.

ODC



B1

d	Ref.	Pack	€
20	ODC020	15	
25	ODC025	20	
32	ODC032	25	
40	ODC040	32	
50	ODC050	40	
63	ODC063	50	
75	ODC075	65	
90	ODC090	80	
110	ODC110	100	

Brida loca.
UNI 2223 PN10. En C-PVC para manguito portabridas.

MIF



Y

d	Ref.	Pack	€
20	MIF020	10	
25	MIF025	10	
32	MIF032	10	
40	MIF040	5	
50	MIF050	5	
63	MIF063	2	
75	MIF075	2	
90	MIF090	2	
110	MIF110	2	

Manguito.
H-H para fusión socket.

ODB



T1

d	Ref.	Pack	€
20	ODB020	15	
25	ODB025	20	
32	ODB032	25	
40	ODB040	32	
50	ODB050	40	
63	ODB063	50	
75	ODB075	65	
90	ODB090	80	
125	**ODB125	100	

Brida loca. [Más diámetros en página 320](#)
En PP con alma de acero. ****Para uso con portabridas QRNF110.**
PN10. Para manguito portabridas.
Versión ANSI 150 lbs (ver OAB página 320)

RIF



Y

dm x dh	Ref.	Pack	€
20 x 16	RIF020016	10	
25 x 20	RIF025020	10	
32 x 25	RIF032025	10	
40 x 25	RIF040025	10	
40 x 32	RIF040032	10	
50 x 32	RIF050032	5	
50 x 40	RIF050040	5	
63 x 32	RIF063032	5	
63 x 50	RIF063050	5	
75 x 63	RIF075063	2	
90 x 63	RIF090063	2	
90 x 75	RIF090075	2	
110 x 90	RIF110090	2	

Reducción cónica.
M-H para fusión socket.

BIGF



Y

d	Ref.	Pack	€	FKM
20	BIGF020F	10		
25	BIGF025F	10		
32	BIGF032F	10		
40	BIGF040F	2		
50	BIGF050F	2		
63	BIGF063F	2		

Unión 3 piezas.
Junta FKM.
H-H para fusión socket.



INDUSTRIA

Sistema PVDF Válvulas de bola



Consultar precios



BIFXF

Y

d x Rh	Ref.	€ FKM
20 x 1/2"	BIFXF020012F	
25 x 3/4"	BIFXF025034F	
32 x 1"	BIFXF032100F	
40 x 1 1/4"	BIFXF040114F	
50 x 1 1/2"	BIFXF050112F	
63 x 2"	BIFXF063200F	

Unión 3 piezas mixto PVDF / Inox A316L.

Junta FKM.

H-H para fusión socket - roscar inox



BIRXF

Y

d x Rm	Ref.	€ FKM
20 x 1/2"	BIRXF020012F	
25 x 3/4"	BIRXF025034F	
32 x 1"	BIRXF032100F	
40 x 1 1/4"	BIRXF040114F	
50 x 1 1/2"	BIRXF050112F	
63 x 2"	BIRXF063200F	

Unión 3 piezas mixto PVDF / Inox A316L.

Junta FKM.

H-M para fusión socket - roscar inox



VKDIF

Z

d	Ref.	DN	PN	€ FKM
16	VKDIF016F	10	16	
20	VKDIF020F	15	16	
25	VKDIF025F	20	16	
32	VKDIF032F	25	16	
40	VKDIF040F	32	16	
50	VKDIF050F	40	16	
63	VKDIF063F	50	16	

Válvula de bola DUAL BLOCK®.

Asiento PTFE (teflón). Bidireccional.

H-H para fusión socket.



VKDDF

Z

d	Ref.	DN	PN	€ FKM
20	VKDDF020F	15	16	
25	VKDDF025F	20	16	
32	VKDDF032F	25	16	
40	VKDDF040F	32	16	
50	VKDDF050F	40	16	
63	VKDDF063F	50	16	

Válvula de bola DUAL BLOCK®.

Asiento PTFE (teflón). Bidireccional.

M-M para fusión socket.



VKDIF

Z

d	Ref.	DN	PN	€ FKM
75	VKDIF075F	65	16	
90	VKDIF090F	80	16	
110	VKDIF110F	100	16	

Válvula de bola DUAL BLOCK®.

Asiento PTFE (teflón). Bidireccional.

H-H para fusión socket.



VKDDF

Z

d	Ref.	DN	PN	€ FKM
75	VKDDF075F	65	16	
90	VKDDF090F	80	16	
110	VKDDF110F	100	16	

Válvula de bola DUAL BLOCK®.

Asiento PTFE (teflón). Bidireccional.

M-M para fusión socket.

Consultar precios

**VKDBF**

Z

d	Ref.	DN	PN	€ FKM
20	VKDBF020F	15	16	
25	VKDBF025F	20	16	
32	VKDBF032F	25	16	
40	VKDBF040F	32	16	
50	VKDBF050F	40	16	
63	VKDBF063F	50	16	

Válvula de bola DUAL BLOCK®.
Asiento PTFE (teflón). Bidireccional.
M-M para fusión a tope.

**VKDOF**

Z

d	Ref.	DN	PN	€ FKM
20	VKDOF020F	15	16	
25	VKDOF025F	20	16	
32	VKDOF032F	25	16	
40	VKDOF040F	32	16	
50	VKDOF050F	40	16	
63	VKDOF063F	50	16	

Válvula de bola DUAL BLOCK®.
Asiento PTFE (teflón). Bidireccional.
Con brida loca.

Versión con bridas ANSI 150 lbs
al mismo precio

**VKDBF**

Z

d	Ref.	DN	PN	€ FKM
75	VKDBF075F	65	16	
90	VKDBF090F	80	16	
110	VKDBF110F	100	16	

Válvula de bola DUAL BLOCK®.
Asiento PTFE (teflón). Bidireccional.
M-M para fusión a tope.

**VKDOF**

Z

d	Ref.	DN	PN	€ FKM
75	VKDOF075F	65	16	
90	VKDOF090F	80	16	
110	VKDOF110F	100	16	

Válvula de bola DUAL BLOCK®.
Asiento PTFE (teflón). Bidireccional.
Con brida loca DIN y ANSI.

**SETFLOI**

Z

d DIN	d ANSI	Ref.	€ DIN 2501	€ ANSI
20	1/2"	SETFLOF020		
25	3/4"	SETFLOF025		
32	1"	SETFLOF032		
40	1 1/4"	SETFLOF040		
50	1 1/2"	SETFLOF050		

Set embrizado.

Compuesto por 1 brida, 1 anillo fijación y 1 tuerca.
Para Válvulas VKD / VKR / SR.

d DIN	d ANSI	Ref.	€ DIN 2501	€ ANSI
63	2"	SETFLOF063		
75	2 1/2"	SETFLOF075		
90	3"	SETFLOF090		
110	4"	SETFLOF110		

d. 75-90-110, es el mismo artículo para DIN y ANSI

Consultar precios



VKRIF

Z

d	Ref.	DN	PN	€ FKM
16	VKRIF016F	10	16	
20	VKRIF020F	15	16	
25	VKRIF025F	20	16	
32	VKRIF032F	25	16	
40	VKRIF040F	32	16	
50	VKRIF050F	40	16	
63	VKRIF063F	50	16	

Válvula de bola **REGULACIÓN** DUAL BLOCK®.
Asiento PTFE (teflón). Bidireccional
H-H para fusión socket.



VKRDF

Z

d	Ref.	DN	PN	€ FKM
20	VKRDF020F	15	16	
25	VKRDF025F	20	16	
32	VKRDF032F	25	16	
40	VKRDF040F	32	16	
50	VKRDF050F	40	16	
63	VKRDF063F	50	16	

Válvula de bola **REGULACIÓN** DUAL BLOCK®.
Asiento PTFE (teflón). Bidireccional
M-M para fusión socket.



VKROF

Z

d	Ref.	DN	PN	€ FKM
20	VKROF020F	15	16	
25	VKROF025F	20	16	
32	VKROF032F	25	16	
40	VKROF040F	32	16	
50	VKROF050F	40	16	
63	VKROF063F	50	16	

Válvula de bola **REGULACIÓN** DUAL BLOCK®.
Asiento PTFE (teflón). Bidireccional
Con brida DIN 2501.



VKROAF

Z

d	Ref.	DN	PN	€ FKM
½"	VKROAF012F	15	16	
¾"	VKROAF034F	20	16	
1"	VKROAF100F	25	16	
1¼"	VKROAF114F	32	16	
1½"	VKROAF112F	40	16	
2"	VKROAF200F	50	16	

Válvula de bola **REGULACIÓN** DUAL BLOCK®.
Asiento PTFE (teflón). Bidireccional
Con bridas ANSI 150 lbs.



INDUSTRIA

Sistema PVDF Válvulas de mariposa



Consultar precios



FKOF/FM

G

d	Ref.	DN	€ FKM
50	FKOFFM050F	40	
63	FKOFFM063F	50	
75	FKOFFM075F	65	
90	FKOFFM090F	80	
110	FKOFFM110F	100	
125	FKOFFM140F	125	
140	FKOFFM140F	125	
160	FKOFFM160F	150	
200	FKOFFM225F	200	
225	FKOFFM225F	200	
250**	FKOFFM280F	250	
280**	FKOFFM280F	250	
315**	FKOFFM315F	300	
355**	FKOFFM355F	355	
400**	FKOFFM400F	400	

FKOF/LM

G

d	Ref.	DN	€ FKM
50	FKOFLM050F	40	
63	FKOFLM063F	50	
75	FKOFLM075F	65	
90	FKOFLM090F	80	
110	FKOFLM110F	100	
125	FKOFLM140F	125	
140	FKOFLM140F	125	
160	FKOFLM160F	150	
200	FKOFLM225F	200	
225	FKOFLM225F	200	

Válvula de mariposa industrial.
A EJE LIBRE.

Para actuar. Cuerpo en PPGR,
eje inoxidable y disco en PVDF

** ANSI 150 lbs bajo pedido
al mismo precio.

Válvula de mariposa industrial.
CON MANETA.
Cuerpo en PPGR,
eje inoxidable y disco en PVDF

** ANSI 150 lbs bajo pedido
al mismo precio.



FKOF/RM

G

d	Ref.	DN	€ FKM
75	FKOFRM075F	65	
90	FKOFRM090F	80	
110	FKOFRM110F	100	
125	FKOFRM140F	125	
140	FKOFRM140F	125	
160	FKOFRM160F	150	
200	FKOFRM225F	200	
225	FKOFRM225F	200	
250**	FKOFRM280F	250	
280**	FKOFRM280F	250	
315**	FKOFRM315F	300	
355**	FKOFRM350F	350	
400**	FKOFRM400F	400	

Válvula de mariposa industrial.
CON VOLANTE.

Cuerpo en PPGR,
eje inoxidable y disco en PVDF

** ANSI 150 lbs bajo pedido
al mismo precio.

FKOF/LM

G

d	Ref.	DN	€ FKM
75	FKOLFRLM075F	65	
90	FKOLFRLM090F	80	
110	FKOLFRLM110F	100	
125	FKOLFRLM140F	125	
140	FKOLFRLM140F	125	
160	FKOLFRLM160F	150	
200	FKOLFRLM225F	200	
225	FKOLFRLM225F	200	

Válvula de mariposa industrial. **CON MANETA. LUG ISO-DIN.**
Cuerpo en PPGR,
eje inoxidable y disco en PVDF

Consultar precios

FKOF/RM

G

d	Ref.	DN	€ FKM
75	FKOLFRM075F	65	
90	FKOLFRM090F	80	
110	FKOLFRM110F	100	
125	FKOLFRM140F	125	
140	FKOLFRM140F	125	
160	FKOLFRM160F	150	
200	FKOLFRM225F	200	
225	FKOLFRM225F	200	

Válvula de mariposa industrial. **CON VOLANTE. LUG ISO-DIN.**
 Cuerpo en PPGR, eje inoxidable y disco en PVDF

FKOF/LM

G

d	Ref.	DN	€ FKM
2½"	FKOALFLM212F	65	
3"	FKOALFLM300F	80	
4"	FKOALFLM400F	100	
5"	FKOALFLM500F	125	
6"	FKOALFLM600F	150	
8"	FKOALFLM800F	200	

Válvula de mariposa industrial. **CON MANETA. LUG ANSI.**
 Cuerpo en PPGR,
 eje inoxidable y disco en PVDF

FKOF/RM

G

d	Ref.	DN	€ FKM
2½"	FKOALFRM212F	65	
3"	FKOALFRM300F	80	
4"	FKOALFRM400F	100	
5"	FKOALFRM500F	125	
6"	FKOALFRM600F	150	
8"	FKOALFRM800F	200	
10"	FKOALFRM810F	250	
12"	FKOALFRM812F	300	

Válvula de mariposa industrial. **CON VOLANTE. LUG ANSI.**
 Cuerpo en PPGR, eje inoxidable y disco en PVDF



INDUSTRIA

Sistema PVDF

Válvulas de membrana



Consultar precios



DKDF

A1

d	Ref.	DN	PN	€ EPDM	€ FKM	€ PTFE
20	DKDF020E	15	10			
25	DKDF025E	20	10			
32	DKDF032E	25	10			
40	DKDF040E	32	10			
50	DKDF050E	40	10			
63	DKDF063E	50	10			
75	DKDF075E	65	10			

Válvula de membrana
DIALOCK®.
M-M para soldar socket.

Código en FKM termina en "F"
en lugar de "E"
Código en PTFE termina en "P"
en lugar de "E"



VMDF

A1

d	Ref.	DN	€ EPDM	€ FKM	€ PTFE
90	VMDF090E	80			
110	VMDF110E	100			

Válvula de membrana.
M-M para fusión socket.

Código en FKM termina en "F"
en lugar de "E"
Código en PTFE termina en "P"
en lugar de "E"



VMOF

A1

d	Ref.	DN	€ EPDM	€ FKM	€ PTFE
90	VMOF090E	80			
110	VMOF110E	100			

Válvula de membrana.
Con bridas DIN. Bajo pedido
con bridas ANSI 150 lbs,
la mismo precio.

Código en FKM termina en "F"
en lugar de "E"
Código en PTFE termina en "P"
en lugar de "E"



DKUIF

A1

d	Ref. FKM	DN	PN	€ EPDM	€ FKM	€ PTFE
20	DKUIF020E	15	10			
25	DKUIF025E	20	10			
32	DKUIF032E	25	10			
40	DKUIF040E	32	10			
50	DKUIF050E	40	10			
63	DKUIF063E	50	10			

Válvula de membrana
DIALOCK®.
Con enlaces H-H para soldar socket.

Código en FKM termina en "F"
en lugar de "E"
Código en PTFE termina en "P"
en lugar de "E"



DKOF

A1

d	Ref.	DN	PN	€ EPDM	€ FKM	€ PTFE
20	DKOF020E	15	10			
25	DKOF025E	20	10			
32	DKOF032E	25	10			
40	DKOF040E	32	10			
50	DKOF050E	40	10			
63	DKOF063E	50	10			
75*	DKOF075E	65	10			

Válvula de membrana
DIALOCK®.
Con bridas DIN

Código en FKM termina en "F"
en lugar de "E"
Código en PTFE termina en "P"
en lugar de "E"



DKOAF

A1

d	Ref.	DN	PN	€ EPDM	€ FKM	€ PTFE
1/2"	DKOAF012E	15	10			
3/4"	DKOAF034E	20	10			
1"	DKOAF100E	25	10			
1 1/4"	DKOAF114E	32	10			
1 1/2"	DKOAF112E	40	10			
2"	DKOAF200E	50	10			
2 1/2"	DKOAF212E	65	10			

Válvula de membrana
DIALOCK®.
Con bridas ANSI 150 lbs.

Código en FKM termina en "F"
en lugar de "E"
Código en PTFE termina en "P"
en lugar de "E"

CMDF

M-M fusión
socket.

CMUIF

H-H enlaces
socket.

CMIF

H-H fusión
socket.

CMFF

H-H roscar.



A1

d-Rh	Ref. EPDM	DN	€ EPDM	€ FKM	€ PTFE
20	CMDF020E	15			
16	CMIF016E	12			
20	CMIF020E	15			
20	CMUIF020E	15			
3/8"	CMFF038E	12			
1/2"	CMFF012E	15			

Válvula de membrana
compacta.

Código en FKM termina en "F" en lugar de "E"
Código en PTFE termina en "P" en lugar de "E"



INDUSTRIA

Sistema PVDF

Válvulas anti-retorno de clapeta



Consultar precios



FROF

d	Ref. FKM	DN	PN	Z	
				€ FKM	€ PTFE
40	FROF040F	32	6		
50	FROF050F	40	6		
63	FROF063F	50	6		
75	FROF075F	65	6		
90	FROF090F	80	6		
110	FROF110F	100	6		
140	FROF140F	125	6		
160	FROF160F	150	6		
225	FROF225F	200	6		
280	FROF280F	250	6		
315	FROF315F	300	6		

Válvula anti-retorno de clapeta sin resorte. [ISO/DIN](#).

Código en PTFE termina en "P" en lugar de "F"



FROF

d	Ref. FKM	DN	PN	Z	
				€ FKM	€ PTFE
40	FROF040FMLX	32	6		
50	FROF050FMLX	40	6		
63	FROF063FMLX	50	6		
75	FROF075FMLX	65	6		
90	FROF090FMLX	80	6		
110	FROF110FMLX	100	6		
140	FROF140FMLX	125	6		
160	FROF160FMLX	150	6		
225	FROF225FMLX	200	6		
280	FROF280FMLX	250	6		
315	FROF315FMLX	300	6		

Válvula anti-retorno de clapeta con resorte inox. [ISO/DIN](#).

Código en PTFE termina en "PMLX" en lugar de "FMLX"



FROAF

d	Ref. FKM	DN	PN	Z	
				€ FKM	€ PTFE
1¼"	FROAF114F	32	6		
1½"	FROAF112F	40	6		
2"	FROAF200F	50	6		
2½"	FROAF212F	65	6		
3"	FROAF300F	80	6		
4"	FROAF400F	100	6		
5"	FROAF500F	125	6		
6"	FROAF600F	150	6		
8"	FROAF800F	200	6		
10"	FROAF810F	250	6		
12"	FROAF812F	300	6		

Válvula anti-retorno de clapeta sin resorte. [ANSI 150 lbs.](#)

Código en PTFE termina en "P" en lugar de "F"



FROAF

d	Ref. FKM	DN	PN	Z	
				€ FKM	€ PTFE
1¼"	FROAF114FMLX	32	6		
1½"	FROAF112FMLX	40	6		
2"	FROAF200FMLX	50	6		
2½"	FROAF212FMLX	65	6		
3"	FROAF300FMLX	80	6		
4"	FROAF400FMLX	100	6		
5"	FROAF500FMLX	125	6		
6"	FROAF600FMLX	150	6		
8"	FROAF800FMLX	200	6		
10"	FROAF810FMLX	250	6		
12"	FROAF812FMLX	300	6		

Válvula anti-retorno de clapeta con resorte inox. [ANSI 150 lbs.](#)

Código en PTFE termina en "PMLX" en lugar de "FMLX"



INDUSTRIA

Sistema PVDF

Válvulas de bola actuadas



Consultar precios



SRIF

Z

d	Ref.	DN	PN	€ FKM
20	SRIF020F	15	16	
25	SRIF025F	20	16	
32	SRIF032F	25	16	
40	SRIF040F	32	16	
50	SRIF050F	40	16	
63	SRIF063F	50	16	

Válvula de bola anti-retorno.

Juntas en FKM.

M-H para fusión socket.



K

VKDIF/CE

Soldar

ACTUACIÓN ELÉCTRICA
24-240 V AC/DC

ACTUACIÓN ELÉCTRICA CON BLOQUE DE SEGURIDAD
24-240 V AC/DC

d	Ref.	€	Ref.	€
16	VKFE016F2D		VKFE016F2BD	
20	VKFE020F2D		VKFE020F2BD	
25	VKFE025F2D		VKFE025F2BD	
32	VKFE032F2D		VKFE032F2BD	
40	VKFE040F2D		VKFE040F2BD	
50	VKFE050F2D		VKFE050F2BD	
280	VKFE063F2D		VKFE063F2BD	
315	VKFE075F2D		VKFE075F2BD	
355	VKFE090F2D		VKFE090F2BD	
400	VKFE110F2D		VKFE110F2BD	

Válvula de bola motorizada

en PVDF 2 vías DUAL BLOCK®. Actuación eléctrica.

Disponemos de otras conexiones bajo pedido: bridas, soldar macho y roscar (GAS y NPT)

Bajo pedido podemos suministrar otros actuadores: VALPES, BELIMO...

Bajo pedido también disponibles en 12V AC/DC

Consultar precios

**VKRIF/CE**

Soldar

ACTUACIÓN ELÉCTRICA 24-240 V AC/DC CON POSICIONADOR 4-20 mA

d	Ref.	€
16	VRFE016F2PD	
20	VRFE020F2PD	
25	VRFE025F2PD	
32	VRFE032F2PD	
40	VRFE040F2PD	
50	VRFE050F2PD	
63	VRFE063F2PD	

Válvula de bola **REGULACIÓN** motorizada en PVDF 2 vías DUAL BLOCK®.
Actuación eléctrica con posicionador 4-20 mA.

Disponemos de otras conexiones bajo pedido: bridas, soldar macho y roscar (GAS y NPT)
Bajo pedido podemos suministrar otros actuadores: VALPES, BELIMO...
Bajo pedido también disponibles en 12V AC/DC

VKDIF/CP

Soldar

ACTUACIÓN NEUMÁTICA ALUMINIO

ACTUACIÓN NEUMÁTICA ALUMINIO CON ELECTROVÁLVULA, FINALES DE CARRERA (ELECTROMECAÑICOS) Y REGULADORES DE ESCAPE

d	DOBLE EFECTO		SIMPLE EFECTO		DOBLE EFECTO		SIMPLE EFECTO	
	Ref.	€	Ref.	€	Ref.	€	Ref.	€
16	VKFP016FDED		VKFP016FSED		VKFP016FDEFD		VKFP016FSEFD	
20	VKFP020FDED		VKFP020FSED		VKFP020FDEFD		VKFP020FSEFD	
25	VKFP025FDED		VKFP025FSED		VKFP025FDEFD		VKFP025FSEFD	
32	VKFP032FDED		VKFP032FSED		VKFP032FDEFD		VKFP032FSEFD	
40	VKFP040FDED		VKFP040FSED		VKFP040FDEFD		VKFP040FSEFD	
50	VKFP050FDED		VKFP050FSED		VKFP050FDEFD		VKFP050FSEFD	
63	VKFP063FDED		VKFP063FSED		VKFP063FDEFD		VKFP063FSEFD	
75	VKFP075FDED		VKFP075FSED		VKFP075FDEFD		VKFP075FSEFD	
90	VKFP090FDED		VKFP090FSED		VKFP090FDEFD		VKFP090FSEFD	
110	VKFP110FDED		VKFP110FSED		VKFP110FDEFD		VKFP110FSEFD	

Válvula de bola motorizada en PVDF 2 vías DUAL BLOCK®.
Actuación neumática.

Disponemos de otras conexiones bajo pedido: bridas, soldar macho y roscar (NPT)
Las válvulas neumáticas se configuran NC (normalmente cerrada) de serie.
La configuración NA (normalmente abierta) se debe especificar en el pedido

Consultar precios



K

VKRIF/CP

Soldar

ACTUACIÓN NEUMÁTICA ALUMINIO DOBLE EFECTO
CON POSICIONADOR 4-20 mAACTUACIÓN NEUMÁTICA ALUMINIO SIMPLE EFECTO
CON POSICIONADOR 4-20 mA

d	Ref.	€	Ref.	€
16	VRFP016FDEPD		VRFP016FSEPD	
20	VRFP020FDEPD		VRFP020FSEPD	
25	VRFP025FDEPD		VRFP025FSEPD	
32	VRFP032FDEPD		VRFP032FSEPD	
40	VRFP040FDEPD		VRFP040FSEPD	
50	VRFP050FDEPD		VRFP050FSEPD	
63	VRFP063FDEPD		VRFP063FSEPD	

S
O
L
D
A
RF
K
MS
O
L
D
A
RF
K
MVálvula de bola **REGULACIÓN** motorizada en PVDF 2 vías DUAL BLOCK®.

Actuación neumática con posicionador 4-20 mA.

Disponemos de otras conexiones bajo pedido: bridas, soldar macho y roscar (NPT).

Las válvulas neumáticas se configuran NC (normalmente cerrada) de serie. La configuración NA (normalmente abierta) se debe especificar en el pedido.

VKDIF/CP

Soldar

ACTUACIÓN NEUMÁTICA POLIAMIDA

ACTUACIÓN NEUMÁTICA ALUMINIO CON ELECTROVÁLVULA, FINALES DE CARRERA (ELECTROMECAÑICOS) Y REGULADORES DE ESCAPE

d	DOBLE EFECTO		SIMPLE EFECTO		DOBLE EFECTO		SIMPLE EFECTO	
	Ref.	€	Ref.	€	Ref.	€	Ref.	€
16	VKFP016FDEP		VKFP016FSEP		VKFP016FDEFP		VKFP016FSEFP	
20	VKFP020FDEP		VKFP020FSEP		VKFP020FDEFP		VKFP020FSEFP	
25	VKFP025FDEP		VKFP025FSEP		VKFP025FDEFP		VKFP025FSEFP	
32	VKFP032FDEP		VKFP032FSEP		VKFP032FDEFP		VKFP032FSEFP	
40	VKFP040FDEP		VKFP040FSEP		VKFP040FDEFP		VKFP040FSEFP	
50	VKFP050FDEP		VKFP050FSEP		VKFP050FDEFP		VKFP050FSEFP	
63	VKFP063FDEP		VKFP063FSEP		VKFP063FDEFP		VKFP063FSEFP	
75	VKFP075FDEP		VKFP075FSEP		VKFP075FDEFP		VKFP075FSEFP	
90	VKFP090FDEP		VKFP090FSEP		VKFP090FDEFP		VKFP090FSEFP	
110	VKFP110FDEP		VKFP110FSE		VKFP110FDEFP		VKFP110FSEFP	

S
O
L
D
A
RF
K
MS
O
L
D
A
RF
K
M

Válvula de bola motorizada en PVDF 2 vías DUAL BLOCK®. Actuación neumática.

Disponemos de otras conexiones bajo pedido: bridas, soldar macho y roscar (GAS y NPT).

Las válvulas neumáticas se configuran NC (normalmente cerrada) de serie. La configuración NA (normalmente abierta) se debe especificar en el pedido.



INDUSTRIA

Sistema PVDF

Válvulas de mariposa actuadas



Consultar precios



K

VKRIF/CP

Soldar

ACTUACIÓN NEUMÁTICA POLIAMIDA DOBLE EFECTO
CON POSICIONADOR 4-20 mA

ACTUACIÓN NEUMÁTICA POLIAMIDA SIMPLE
EFECTO CON POSICIONADOR 4-20 mA

d	Ref.	€
16	VRFP016FDEPD	
20	VRFP020FDEPD	
25	VRFP025FDEPD	
32	VRFP032FDEPD	
40	VRFP040FDEPD	
50	VRFP050FDEPD	
63	VRFP063FDEPD	

Ref.	€
VRFP016FSEPP	
VRFP020FSEPP	
VRFP025FSEPP	
VRFP032FSEPP	
VRFP040FSEPP	
VRFP050FSEPP	
VRFP063FSEPP	

SOLDAR

SOLDAR

Válvula de bola **REGULACIÓN** motorizada en PVDF 2 vías DUAL BLOCK®. Actuación neumática con posicionador 4-20 mA.

Disponemos de otras conexiones bajo pedido: bridas, soldar macho y roscar (NPT). Las válvulas neumáticas se configuran NC (normalmente cerrada) de serie. La configuración NA (normalmente abierta) se debe especificar en el pedido.

FKOF/CE

Soldar

ACTUACIÓN ELÉCTRICA
24-240 V AC/DC

ACTUACIÓN ELÉCTRICA CON BLOQUE DE SEGURIDAD
24-240 V AC/DC

d	Ref.	€
50	FKFE050F2D	
63	FKFE063F2D	
75	FKFE075F2D	
90	FKFE090F2D	
110	FKFE110F2D	
125	FKFE140F2D	
140	FKFE140F2D	
160	FKFE160F2D	
200	FKFE225F2D	
225	FKFE225F2D	
250	FKFE280F2D	
280	FKFE280F2D	
315	FKFE315F2D	

Ref.	€
FKFE050F2BD	
FKFE063F2BD	
FKFE075F2BD	
FKFE090F2BD	
FKFE110F2BD	
FKFE140F2BD	
FKFE140F2BD	
FKFE160F2BD	
FKFE225F2BD	
FKFE225F2BD	
FKFE280F2BD	
FKFE280F2BD	
FKFE315F2BD	

FKM

FKM

Válvula de mariposa industrial motorizada cuerpo en PPRG y disco en PVDF. Actuación eléctrica.

Bajo pedido podemos suministrar otros actuadores: VALPES, BELIMO... Bajo pedido también disponibles en 12V AC/DC



K

Consultar precios



FKOF/CP

K

ACTUACIÓN NEUMÁTICA ALUMINIO

ACTUACIÓN NEUMÁTICA ALUMINIO CON ELECTROVÁLVULA, FINALES DE CARRERA (ELECTROMECAÑICOS) Y REGULADORES DE ESCAPE

d	DOBLE EFECTO		SIMPLE EFECTO		DOBLE EFECTO		SIMPLE EFECTO	
	Ref.	€	Ref.	€	Ref.	€	Ref.	€
50	FKFP050FDED		FKFP050FSED		FKFP050FDEFD		FKFP050FSEFD	
63	FKFP063FDED		FKFP063FSED		FKFP063FDEFD		FKFP063FSEFD	
75	FKFP075FDED		FKFP075FSED		FKFP075FDEFD		FKFP075FSEFD	
90	FKFP090FDED		FKFP090FSED		FKFP090FDEFD		FKFP090FSEFD	
F 110	FKFP110FDED		FKFP110FSED		FKFP110FDEFD		FKFP110FSEFD	F
K 125	FKFP140FDED		FKFP140FSED		FKFP140FDEFD		FKFP140FSEFD	K
M 140	FKFP140FDED		FKFP140FSED		FKFP140FDEFD		FKFP140FSEFD	M
160	FKFP160FDED		FKFP160FSED		FKFP160FDEFD		FKFP160FSEFD	
200	FKFP225FDED		FKFP225FSED		FKFP225FDEFD		FKFP225FSEFD	
225	FKFP225FDED		FKFP225FSED		FKFP225FDEFD		FKFP225FSEFD	
250	FKFP280FDED		FKFP280FSED		FKFP280FDEFD		FKFP280FSEFD	
280	FKFP280FDED		FKFP280FSED		FKFP280FDEFD		FKFP280FSEFD	
315	FKFP315FDED		FKFP315FSED		FKFP315FDEFD		FKFP315FSEFD	

Válvula de mariposa industrial motorizada
cuerpo en PPGR y disco en PVDF.

Actuación neumática.

Las válvulas neumáticas se configuran NC (normalmente cerrada) de serie.
La configuración NA (normalmente abierta) se debe especificar en el pedido.

FKOF/CP

K

ACTUACIÓN NEUMÁTICA POLIAMIDA

ACTUACIÓN NEUMÁTICA POLIAMIDA CON ELECTROVÁLVULA, FINALES DE CARRERA (ELECTROMECAÑICOS) Y REGULADORES DE ESCAPE

d	DOBLE EFECTO		SIMPLE EFECTO		DOBLE EFECTO		SIMPLE EFECTO	
	Ref.	€	Ref.	€	Ref.	€	Ref.	€
50	FKFP050FDEP		FKFP050FSEP		FKFP050FDEFP		FKFP050FSEFP	
63	FKFP063FDEP		FKFP063FSEP		FKFP063FDEFP		FKFP063FSEFP	
75	FKFP075FDEP		FKFP075FSEP		FKFP075FDEFP		FKFP075FSEFP	
90	FKFP090FDEP		FKFP090FSEP		FKFP090FDEFP		FKFP090FSEFP	
F 110	FKFP110FDEP		FKFP110FSEP		FKFP110FDEFP		FKFP110FSEFP	F
K 125	FKFP140FDEP		FKFP140FSEP		FKFP140FDEFP		FKFP140FSEFP	K
M 140	FKFP140FDEP		FKFP140FSEP		FKFP140FDEFP		FKFP140FSEFP	M
160	FKFP160FDEP		FKFP160FSEP		FKFP160FDEFP		FKFP160FSEFP	
200	FKFP225FDEP		FKFP225FSEP		FKFP225FDEFP		FKFP225FSEFP	
225	FKFP225FDEP		FKFP225FSEP		FKFP225FDEFP		FKFP225FSEFP	
250*	FKFP280FDEP		FKFP280FSEP		FKFP280FDEFP		FKFP280FSEFP	
280*	FKFP280FDEP		FKFP280FSEP		FKFP280FDEFP		FKFP280FSEFP	
315*	FKFP315FDEP		FKFP315FSEP		FKFP315FDEFP		FKFP315FSEFP	

Válvula de mariposa industrial motorizada
cuerpo en PPGR y disco en PVDF.

Actuación neumática.

Las válvulas neumáticas se configuran NC (normalmente cerrada) de serie.
La configuración NA (normalmente abierta) se debe especificar en el pedido.

* Actuadores de aluminio



INDUSTRIA

Sistema PVDF

Válvulas de membrana actuadas



Consultar precios



DK/CP NC			VM/CP NC					L
d	Modelo	DN	Ref. EPDM	€ EPDM	Ref. FKM	€ FKM	Ref. PTFE	€ PTFE
20	DKDF/CP NC	15	DKDFNC020E		DKDFNC020F		DKDFNC020P	
25	DKDF/CP NC	20	DKDFNC025E		DKDFNC025F		DKDFNC025P	
32	DKDF/CP NC	25	DKDFNC032E		DKDFNC032F		DKDFNC032P	
40	DKDF/CP NC	32	DKDFNC040E		DKDFNC040F		DKDFNC040P	
50	DKDF/CP NC	40	DKDFNC050E		DKDFNC050F		DKDFNC050P	
63	DKDF/CP NC	50	DKDFNC063E		DKDFNC063F		DKDFNC063P	
75	DKDF/CP NC	65	DKDFNC075E		DKDFNC075F		DKDFNC075P	
90	VMDF/CP NC	80	VMDFNC090E		VMDFNC090F		VMDFNC090P	
110	VMDF/CP NC	100	VMDFNC110E		VMDFNC110F		VMDFNC110P	

Válvula neumática **NORMALMENTE CERRADA.**

M-M soldar socket.



DK/CP NO			VM/CP NO					L
d	Modelo	DN	Ref. EPDM	€ EPDM	Ref. FKM	€ FKM	Ref. PTFE	€ PTFE
20	DKDF/CP NO	15	DKDFNO020E		DKDFNO020F		DKDFNO020P	
25	DKDF/CP NO	20	DKDFNO025E		DKDFNO025F		DKDFNO025P	
32	DKDF/CP NO	25	DKDFNO032E		DKDFNO032F		DKDFNO032P	
40	DKDF/CP NO	32	DKDFNO040E		DKDFNO040F		DKDFNO040P	
50	DKDF/CP NO	40	DKDFNO050E		DKDFNO050F		DKDFNO050P	
63	DKDF/CP NO	50	DKDFNO063E		DKDFNO063F		DKDFNO063P	
75	DKDF/CP NO	65	DKDFNO075E		DKDFNO075F		DKDFNO075P	
90	VMDF/CP NO	80	VMDFNO090E		VMDFNO090F		VMDFNO090P	
110	VMDF/CP NO	100	VMDFNO110E		VMDFNO110F		VMDFNO110P	

Válvula neumática **NORMALMENTE ABIERTA.**

M-M soldar socket.



DK/CP DE			VM/CP DE					L
d	Modelo	DN	Ref. EPDM	€ EPDM	Ref. FKM	€ FKM	Ref. PTFE	€ PTFE
20	DKDF/CP DE	15	DKDFDA020E		DKDFDA020F		DKDFDA020P	
25	DKDF/CP DE	20	DKDFDA025E		DKDFDA025F		DKDFDA025P	
32	DKDF/CP DE	25	DKDFDA032E		DKDFDA032F		DKDFDA032P	
40	DKDF/CP DE	32	DKDFDA040E		DKDFDA040F		DKDFDA040P	
50	DKDF/CP DE	40	DKDFDA050E		DKDFDA050F		DKDFDA050P	
63	DKDF/CP DE	50	DKDFDA063E		DKDFDA063F		DKDFDA063P	
75	DKDF/CP DE	65	DKDFDA075E		DKDFDA075F		DKDFDA075P	
90	VMDF/CP DE	80	VMDFDA090E		VMDFDA090F		VMDFDA090P	
110	VMDF/CP DE	100	VMDFDA110E		VMDFDA110F		VMDFDA110P	

Válvula neumática **DOBLE EFECTO.**

M-M soldar socket.

Consultar precios



DK/CP NC

L

d	Modelo	DN	Ref. EPDM	€ EPDM	Ref. FKM	€ FKM	Ref. PTFE	€ PTFE
20	DKUIF/CP NC	15	DKUIFNC020E		DKUIFNC020F		DKUIFNC020P	
25	DKUIF/CP NC	20	DKUIFNC025E		DKUIFNC025F		DKUIFNC025P	
32	DKUIF/CP NC	25	DKUIFNC032E		DKUIFNC032F		DKUIFNC032P	
40	DKUIF/CP NC	32	DKUIFNC040E		DKUIFNC040F		DKUIFNC040P	
50	DKUIF/CP NC	40	DKUIFNC050E		DKUIFNC050F		DKUIFNC050P	
63	DKUIF/CP NC	50	DKUIFNC063E		DKUIFNC063F		DKUIFNC063P	

Válvula neumática **NORMALMENTE CERRADA.**

Con enlaces H-H para soldar socket.



DK/CP NO

L

d	Modelo	DN	Ref. EPDM	€ EPDM	Ref. FKM	€ FKM	Ref. PTFE	€ PTFE
20	DKUIF/CP NO	15	DKUIFNO020E		DKUIFNO020F		DKUIFNO020P	
25	DKUIF/CP NO	20	DKUIFNO025E		DKUIFNO025F		DKUIFNO025P	
32	DKUIF/CP NO	25	DKUIFNO032E		DKUIFNO032F		DKUIFNO032P	
40	DKUIF/CP NO	32	DKUIFNO040E		DKUIFNO040F		DKUIFNO040P	
50	DKUIF/CP NO	*40	DKUIFNO050E		DKUIFNO050F		DKUIFNO050P	
63	DKUIF/CP NO	*50	DKUIFNO063E		DKUIFNO063F		DKUIFNO063P	

Válvula neumática **NORMALMENTE ABIERTA.**

Con enlaces H-H para soldar socket.

* Válvulas NO-DE



DK/CP DE

L

d	Modelo	DN	Ref. EPDM	€ EPDM	Ref. FKM	€ FKM	Ref. PTFE	€ PTFE
20	DKUIF/CP DE	15	DKUIFDA020E		DKUIFDA020F		DKUIFDA020P	
25	DKUIF/CP DE	20	DKUIFDA025E		DKUIFDA025F		DKUIFDA025P	
32	DKUIF/CP DE	25	DKUIFDA032E		DKUIFDA032F		DKUIFDA032P	
40	DKUIF/CP DE	32	DKUIFDA040E		DKUIFDA040F		DKUIFDA040P	
50	DKUIF/CP DE	*40	DKUIFDA050E		DKUIFDA050F		DKUIFDA050P	
63	DKUIF/CP DE	*50	DKUIFDA063E		DKUIFDA063F		DKUIFDA063P	

Válvula neumática **DOBLE EFECTO.**

Con enlaces H-H para soldar socket.

Consultar precios

DK/CP NC				VM/CP NC				L
d	Modelo	DN	Ref. EPDM	€ EPDM	Ref. FKM	€ FKM	Ref. PTFE	€ PTFE
20	DKOF/CP NC	15	DKOFNC020E		DKOFNC020F		DKOFNC020P	
25	DKOF/CP NC	20	DKOFNC025E		DKOFNC025F		DKOFNC025P	
32	DKOF/CP NC	25	DKOFNC032E		DKOFNC032F		DKOFNC032P	
40	DKOF/CP NC	32	DKOFNC040E		DKOFNC040F		DKOFNC040P	
50	DKOF/CP NC	40	DKOFNC050E		DKOFNC050F		DKOFNC050P	
63	DKOF/CP NC	50	DKOFNC063E		DKOFNC063F		DKOFNC063P	
75	DKOF/CP NC	65	DKOFNC075E		DKOFNC075F		DKOFNC075P	
90	VMOF/CP NC	80	VMOFNC090E		VMOFNC090F		VMOFNC090P	
110	VMOF/CP NC	100	VMOFNC110E		VMOFNC110F		VMOFNC110P	

Válvula neumática **NORMALMENTE CERRADA.**

Con bridas DIN.

Disponibles con bridas ANSI 150 libras al mismo precio

DK/CP NO				VM/CP NO				L
d	Modelo	DN	Ref. EPDM	€ EPDM	Ref. FKM	€ FKM	Ref. PTFE	€ PTFE
20	DKOF/CP NO	15	DKOFNO020E		DKOFNO020F		DKOFNO020P	
25	DKOF/CP NO	20	DKOFNO025E		DKOFNO025F		DKOFNO025P	
32	DKOF/CP NO	25	DKOFNO032E		DKOFNO032F		DKOFNO032P	
40	DKOF/CP NO	32	DKOFNO040E		DKOFNO040F		DKOFNO040P	
50	DKOF/CP NO	40	DKOFNO050E		DKOFNO050F		DKOFNO050P	
63	DKOF/CP NO	50	DKOFNO063E		DKOFNO063F		DKOFNO063P	
75	DKOF/CP NO	65	DKOFNO075E		DKOFNO075F		DKOFNO075P	
90	VMOF/CP NO	80	VMOFNO090E		VMOFNO090F		VMOFNO090P	
110	VMOF/CP NO	100	VMOFNO110E		VMOFNO110F		VMOFNO110P	

Válvula neumática **NORMALMENTE ABIERTA.**

Con bridas DIN.

Disponibles con bridas ANSI 150 libras al mismo precio

DK/CP DE				VM/CP DE				L
d	Modelo	DN	Ref. EPDM	€ EPDM	Ref. FKM	€ FKM	Ref. PTFE	€ PTFE
20	DKOF/CP DE	15	DKOFDA020E		DKOFDA020F		DKOFDA020P	
25	DKOF/CP DE	20	DKOFDA025E		DKOFDA025F		DKOFDA025P	
32	DKOF/CP DE	25	DKOFDA032E		DKOFDA032F		DKOFDA032P	
40	DKOF/CP DE	32	DKOFDA040E		DKOFDA040F		DKOFDA040P	
50	DKOF/CP DE	40	DKOFDA050E		DKOFDA050F		DKOFDA050P	
63	DKOF/CP DE	50	DKOFDA063E		DKOFDA063F		DKOFDA063P	
75	DKOF/CP DE	65	DKOFDA075E		DKOFDA075F		DKOFDA075P	
90	VMOF/CP DE	80	VMOFDA090E		VMOFDA090F		VMOFDA090P	
110	VMOF/CP DE	100	VMOFDA110E		VMOFDA110F		VMOFDA110P	

Válvula neumática **DOBLE EFECTO.**

Con bridas DIN.

Disponibles con bridas ANSI 150 libras al mismo precio

Consultar precios

CMDF/CP NC *M-M para fusión socket*
CMIF/CP NC *H-H para fusión socket*
CMUIF/CP NC *H-H enlaces fusión socket*
CMFF/CP NC *H-H roscar*



d-Rh	Ref. EPDM	DN	€ EPDM	€ FKM	€ PTFE
20	CMDFNC020E	15			
16	CMIFNC016E	12			
20	CMIFNC020E	15			
20	CMUIFNC020E	15			
3/8"	CMFFNC038E	12			
1/2"	CMFFNC012E	15			

Válvula de membrana compacta neumática
NORMALMENTE CERRADA

Código en FKM termina en "F" en lugar de "E"
 Código en PTFE termina en "P" en lugar de "E"
 (A) = Juntas en FKM

CMDF/CP NO *M-M para fusión socket*
CMIF/CP NO *H-H para fusión socket*
CMUIF/CP NO *H-H enlaces fusión socket*
CMFF/CP NO *H-H roscar*



d-Rh	Ref. EPDM	DN	€ EPDM	€ FKM	€ PTFE
20	CMDFNO020E	15			
16	CMIFNO016E	12			
20	CMIFNO020E	15			
20	CMUIFNO020E	15			
3/8"	CMFFNO038E	12			
1/2"	CMFFNO012E	15			

Válvula de membrana compacta neumática
NORMALMENTE ABIERTA

Código en FKM termina en "F" en lugar de "E"
 Código en PTFE termina en "P" en lugar de "E"
 (A) = Juntas en FKM

CMDF/CP DE *M-M para fusión socket*
CMIF/CP DE *H-H para fusión socket*
CMUIF/CP DE *H-H enlaces fusión socket*
CMFF/CP DE *H-H roscar*



d-Rh	Ref. EPDM	DN	€ EPDM	€ FKM	€ PTFE
20	CMDFDA020E	15			
16	CMIFDA016E	12			
20	CMIFDA020E	15			
20	CMUIFDA020E	15			
3/8"	CMFFDA038E	12			
1/2"	CMFFDA012E	15			

Válvula de membrana compacta neumática
DOBLE EFECTO

Código en FKM termina en "F" en lugar de "E"
 Código en PTFE termina en "P" en lugar de "E"
 (A) = Juntas en FKM



INDUSTRIA

Sistema PVDF

Válvulas de control de presión



Consultar precios



VSF

L

d	Ref. EPDM	DN	PN	€ PTFE
16	VSFBF016P	10	10	
20	VSFBF020P	15	10	
25	VSFBF025P	20	10	
32	VSFBF032P	25	10	
40	VSFBF040P	32	10	
50	VSFBF050P	40	10	
63	VSFBF063P	50	10	

Válvula de sobrepresión-alivio. Rango de calibración: 0,5 - 10 bars
M-M para soldadura a testa.



VCP

L

d	Ref. EPDM	DN	PN	€ PTFE
16	VCPBF016P	10	10	
20	VCPBF020P	15	10	
25	VCPBF025P	20	10	
32	VCPBF032P	25	10	
40	VCPBF040P	32	10	
50	VCPBF050P	40	10	
63	VCPBF063P	50	10	

Válvula retenedora de presión. Rango de calibración: 0,5 - 10 bars
M-M para soldadura a testa.



VPR

L

d	Ref. EPDM	DN	PN	€ PTFE
16	VPRBF016F	10	10	
20	VPRBF020F	15	10	
25	VPRBF025F	20	10	
32	VPRBF032F	25	10	
40	VPRBF040F	32	10	
50	VPRBF050F	40	10	
63	VPRBF063F	50	10	

Válvula reductora de presión. Rango de calibración: 0,5 - 9 bars
M-M para soldadura a testa.



VPR

L

d	Ref. EPDM	DN	PN	€ PTFE
16	VPRDF016E	10	10	
20	VPRDF020E	15	10	
25	VPRDF025E	20	10	
32	VPRDF032E	25	10	
40	VPRDF040E	32	10	
50	VPRDF050E	40	10	
63	VPRDF063E	50	10	

Válvula reductora de presión. Rango de calibración: 0,5 - 9 bars
M-M para fusión socket.



INDUSTRIA

Sistema PVDF

Conectores



Consultar precios



MANGUITO

Y

d	Ref. EPDM	Para válvulas	€
16	ENDIF016	VKD-VKR-SR	
20	ENDIF020	VKD-VKR-SR	
25	ENDIF025	VKD-VKR-SR	
32	ENDIF032	VKD-VKR-SR	
40	ENDIF040	VKD-VKR-SR	
50	ENDIF050	VKD-VKR-SR	
63	ENDIF063	VKD-VKR-SR	
75	ENDIF075	VKD	
90	ENDIF090	VKD	
110	ENDIF110	VKD	

Conector final en PVDF.
H para soldar socket.



MANGUITO

Y

d	Ref. EPDM	Para válvulas	€
20	ENDDF020	VKD-VKR-SR	
25	ENDDF025	VKD-VKR-SR	
32	ENDDF032	VKD-VKR-SR	
40	ENDDF040	VKD-VKR-SR	
50	ENDDF050	VKD-VKR-SR	
63	ENDDF063	VKD-VKR-SR	
75	ENDDF075	VKD	
90	ENDDF090	VKD	
110	ENDDF110	VKD	

Conector final en PVDF.
M para soldar socket.



MANGUITO

Y

Rh	Ref. EPDM	Para válvulas	€
1/2"	ENDFF012	VKD-VKR-SR	
3/4"	ENDFF034	VKD-VKR-SR	
1"	ENDFF100	VKD-VKR-SR	
1 1/4"	ENDFF114	VKD-VKR-SR	
1 1/2"	ENDFF112	VKD-VKR-SR	
2"	ENDFF200	VKD-VKR-SR	

Conector final en PVDF.
H rosca GAS.



CVDF

Y

d	Ref. EPDM	Para válvulas	€
20	CVDF21020	VKD-VKR-SR	
25	CVDF21025	VKD-VKR-SR	
32	CVDF21032	VKD-VKR-SR	
40	CVDF21040	VKD-VKR-SR	
50	CVDF21050	VKD-VKR-SR	
63	CVDF21063	VKD-VKR-SR	
75	CVDF21075	VKD	
90	CVDF21090	VKD	
110	CVDF21110	VKD	

Conector final en PVDF SDR21 PN16.
Para soldar a testa o electrofusión.



CVDF

Y

d	Ref. EPDM	Para válvulas	€
20	QBBFL21020	CM-DK	
25	QBBFL21025	CM-DK	
32	QBBFL21032	CM-DK	
40	QBBFL21040	CM-DK	
50	QBBFL21050	CM-DK	
63	QBBFL21063	CM-DK	

Conector final en PVDF SDR21 PN16.
Para soldar a testa o electrofusión.



MANGUITO

Y

Rh	Ref. EPDM	Para válvulas	€
1/2"	ENDNF012	VKD-VKR-SR	
3/4"	ENDNF034	VKD-VKR-SR	
1"	ENDNF100	VKD-VKR-SR	
1 1/4"	ENDNF114	VKD-VKR-SR	
1 1/2"	ENDNF112	VKD-VKR-SR	
2"	ENDNF200	VKD-VKR-SR	

Conector final en PVDF.
H rosca NPT.

Tubo y accesorios
Válvulas manuales
Válvulas actuadas

Sistema C-PVC

INDUSTRIA



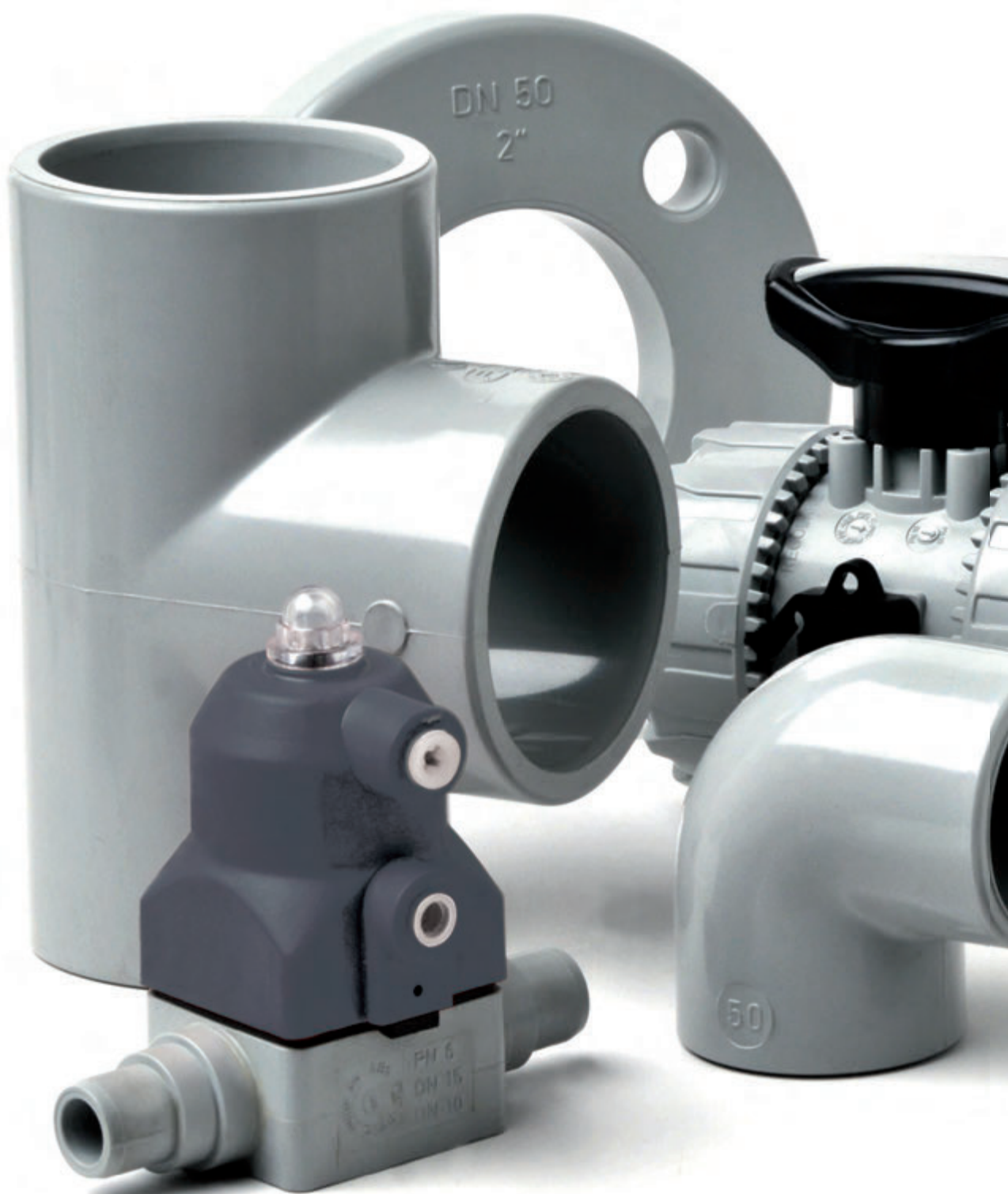

Sistema C-PVC





INDUSTRIA

Sistema C-PVC

Tubo y accesorios



B1

d	Ref.	PN	€/m.
16	PIPEC13016	16	3,28
20	PIPEC13020	16	4,84
25	PIPEC13025	16	7,61
32	PIPEC13032	16	12,31
40	PIPEC13040	16	18,94
50	PIPEC13050	16	28,90
63	PIPEC13063	16	46,25
75	PIPEC13075	16	65,50
90	PIPEC13090	16	93,05
110	PIPEC13110	16	139,28
110	PIPEC21110	10	84,92
160	PIPEC13160	16	314,47
160	PIPEC21160	10	219,74
225	PIPEC21225	10	601,73

Tubo en C-PVC SDR 13,5

Barras de 5 m.

**GIC**

B1

d	Ref.	Pack	€
16	GIC016	10	3,29
20	GIC020	10	3,70
25	GIC025	10	4,63
32	GIC032	10	5,52
40	GIC040	10	7,22
50	GIC050	5	12,59
63	GIC063	2	15,70
75	GIC075	-	29,94
90	GIC090	-	40,14
110	GIC110	-	73,62
160	GIC160	-	183,99
225*	GIC225	-	916,18

Codo 90°.

* PN10

H-H encolar.

**HIC**

B1

d	Ref.	Pack	€
20	HIC020	10	4,42
25	HIC025	10	6,19
32	HIC032	10	7,53
40	HIC040	5	10,87
50	HIC050	5	17,41
63	HIC063	5	26,59
75	HIC075	-	40,96
90	HIC090	-	60,67
110	HIC110	-	98,87
160	HIC160	-	212,59
225*	HIC225	-	696,58

Codo 45°

* PN10

H-H encolar.

**TIC**

B1

d	Ref.	Pack	€
16	TIC016	10	3,42
20	TIC020	10	4,11
25	TIC025	10	5,11
32	TIC032	10	6,19
40	TIC040	5	8,52
50	TIC050	5	14,33
63	TIC063	2	19,42
75	TIC075	-	40,14
90	TIC090	-	57,87
110	TIC110	-	89,30
160	TIC160	-	276,69
225*	TIC225	-	1.085,71

Te a 90°.

* PN10

H-H-H encolar.



TRIC

B1

d x dr	Ref.	Pack	€
25 x 20	TRIC025020	10	4,42
32 x 20	TRIC032020	10	7,53
32 x 25	TRIC032025	10	7,53
40 x 20	TRIC040020	10	10,57
40 x 25	TRIC040025	10	10,57
50 x 25	TRIC050025	10	17,41
50 x 32	TRIC050032	10	17,41
63 x 25	TRIC063025	5	25,25
63 x 32	TRIC063032	5	25,25
75 x 25	TRIC075025	-	48,59
90 x 25	TRIC090025	-	60,48
110 x 25	TRIC110025	-	77,57

Te a 90° reducida.

H-H-H encolar.



TIMC

B1

d x dr	Ref.	Pack	€
16 x 3/8"	TIMC016038	10	7,53
20 x 1/2"	TIMC020012	10	8,20
25 x 3/4"	TIMC025034	10	8,52
32 x 1"	TIMC032100	10	10,57
40 x 1 1/4"	TIMC040114	10	12,87
50 x 1 1/2"	TIMC050112	10	19,74
63 x 2"	TIMC063200	5	24,58

Te a 90°mixta reforzada inox.

H-H-H encolar-rosacar.



MIMC

B1

d x dr	Ref.	Pack	€
16 x 3/8"	MIMC016038	10	4,84
20 x 1/2"	MIMC020012	10	5,11
25 x 3/4"	MIMC025034	10	5,76
32 x 1"	MIMC032100	10	7,18
40 x 1 1/4"	MIMC040114	5	9,87
50 x 1 1/2"	MIMC050112	5	12,87
63 x 2"	MIMC063200	5	17,05

Manguito mixto reforzado inox.

H-H encolar-rosacar.



MIC

B1

d	Ref.	Pack	€
16	MIC016	10	2,38
20	MIC020	10	2,75
25	MIC025	10	3,07
32	MIC032	10	3,77
40	MIC040	5	4,11
50	MIC050	5	6,85
63	MIC063	2	10,57
75	MIC075	-	15,70
90	MIC090	-	26,59
110	MIC110	-	48,38
160	MIC160	-	113,07
225*	MIC225	-	505,18

Manguito.

H-H encolar.

* PN10



GIMC

B1

d x dr	Ref.	Pack	€
16 x 3/8"	GIMC016038	10	5,00
20 x 1/2"	GIMC020012	10	5,98
25 x 3/4"	GIMC025034	10	6,85
32 x 1"	GIMC032100	10	9,87
40 x 1 1/4"	GIMC040114	10	12,23
50 x 1 1/2"	GIMC050112	10	17,70
63 x 2"	GIMC063200	5	23,92

Codo a 90°mixto reforzado inox.

H-H encolar-rosacar.



KIFC

B1

d x dr	Ref.	Pack	€
16 x 3/8"	KIFC20016038	10	4,11
20 x 1/2"	KIFC25020012	10	4,80
25 x 3/4"	KIFC32025034	10	5,11
32 x 1"	KIFC40032100	10	6,19
40 x 1 1/4"	KIFC50040114	5	7,53
50 x 1 1/2"	KIFC63050112	5	8,87
63 x 2"	KIFC75063200	-	15,03

Terminal rosca macho.

M-H encolar - M rosacar



DIC

B1

d x dr	Ref.	Pack	€
20 x 16	DIC020016	10	2,84
25 x 20	DIC025020	10	3,29
32 x 20	DIC032020	10	3,82
32 x 25	DIC032025	10	3,82
40 x 20	DIC040020	10	6,19
40 x 25	DIC040025	10	6,19
40 x 32	DIC040032	10	6,19
50 x 32	DIC050032	10	6,37
50 x 40	DIC050040	10	6,37
63 x 32	DIC063032	5	10,13
63 x 40	DIC063040	5	10,13
63 x 50	DIC063050	5	10,13
75 x 50	DIC075050	5	16,07
75 x 63	DIC075063	-	16,07
90 x 50	DIC090050	-	22,45
90 x 63	DIC090063	-	22,45
90 x 75	DIC090075	-	22,45
110 x 63	DIC110063	-	34,49
110 x 75	DIC110075	-	34,49
110 x 90	DIC110090	-	34,49
160 x 110	DIC160110	-	85,16
225 x 160*	DIC225160	-	348,60

Casquillo reducción.
M-H encolar.

* PN10

CIC

B1

d	Ref.	Pack	€
20	CIC020	10	2,76
25	CIC025	10	4,48
32	CIC032	10	5,87
40	CIC040	10	7,79
50	CIC050	10	12,42
63	CIC063	5	14,33
75	CIC075	-	22,65
90	CIC090	-	32,28
110	CIC110	-	43,39

Tapón hembra.
H encolar.



B1

Ref.	Producto	€
TG724	1) Cola TEMPERGLUE 724	43,63
PCP70	1) Decapante Primer Cleaner P70	18,39
TGBISON	2) Cola TEMPERGLUE 100	43,63
PCBISON	2) Decapante TEMPERFIP 100	18,39

Cola y decapante. ¹⁾ TEMPERGLUE 724 debe utilizarse con PRIMER CLEANER P70.
 Todas las latas son de 500 g.
 Cola especialmente recomendable para la unión de piezas de C-PVC en contacto con fluidos químicamente agresivos (como cloros y bases)

²⁾ TEMPERGLUE 100 debe utilizarse con TEMPERFIP 100.



QRC

B1

d	Ref.	DN	Pack	€
20	QRC020	15	10	4,44
25	QRC025	20	10	5,46
32	QRC032	25	10	6,50
40	QRC040	32	5	7,53
50	QRC050	40	5	7,87
63	QRC063	50	2	9,52
75	QRC075	65	-	14,33
90	QRC090	80	-	21,07
110	QRC110	100	-	32,73
160	QRC160	150	-	113,07
225*	QRC225	200	-	436,72

Manguito portabridas.

* PN10

H encolar. Para usar con brida ODC.



ODC

B1

d	Ref.	DN	Pack	€
20	ODC020	15	2	5,46
25	ODC025	20	2	6,50
32	ODC032	25	2	7,53
40	ODC040	32	2	9,22
50	ODC050	40	2	11,91
63	ODC063	50	2	13,25
75	ODC075	65	2	19,74
90	ODC090	80	2	21,81
110	ODC110	100	2	29,94

Brida loca.

UNI 2223 PN10/16. Para usar con portabridas QRC.



ODB

IT

d	Ref.	DN	€
20	ODB020	15	9,84
25	ODB025	20	10,82
32	ODB032	25	13,95
40	ODB040	32	16,91
50	ODB050	40	19,77
63	ODB063	50	24,58
75	ODB075	65	27,17
90	ODB090	80	32,36
110	ODB125	100	39,05

Brida loca.

Más diámetros en página 320

En PP con alma de acero.

** Para usar con portabridas QRNM110

PN10. Para manguito portabridas.

Versión ANSI 150 lbs (ver OAB página 320)



INDUSTRIA

Sistema C-PVC

Uniones 3 piezas



BIC

d	Ref. EPDM	Pack	B1	
			€ EPDM	€ FKM
16	BIC016E	10	12,23	16,27
20	BIC020E	10	13,68	17,73
25	BIC025E	10	14,73	19,77
32	BIC032E	10	17,70	24,28
40	BIC040E	10	23,92	33,58
50	BIC050E	10	33,08	44,22
63	BIC063E	2	47,00	59,38

Unión 3 piezas.

Junta en EPDM ó FKM.
H-H encolar.

Código en FKM termina en "F"
en lugar de "E"



BIFC

d x Rh	Ref.	Pack	B1	
			€ EPDM	€ FKM
16 x 3/8"	BIFC016038E	10	19,74	
20 x 1/2"	BIFC020012E	10	21,81	
25 x 3/4"	BIFC025034E	10	23,21	
32 x 1"	BIFC032100E	2	25,90	
40 x 1 1/4"	BIFC040114E	2	42,32	
50 x 1 1/2"	BIFC050112E	2	60,67	
63 x 2"	BIFC063200E	2	68,24	

Unión 3 piezas mixto.

Junta en EPDM
H-H encolar-rosocar.



BIFOC

d x Rh	Ref.	Pack	Pack	U/	B1	
					€ EPDM	€ FKM
16 x 3/8"	BIFOC016038E	16	50	100	25,36	
20 x 1/2"	BIFOC020012E	16	40	80	30,46	
25 x 3/4"	BIFOC025034E	16	20	40	40,16	
32 x 1"	BIFOC032100E	16	14	28	47,43	
40 x 1 1/4"	BIFOC040114E	16	8	16	66,22	
50 x 1 1/2"	BIFOC050112E	16	4	8	80,95	
63 x 2"	BIFOC063200E	16	-	12	106,02	

Unión 3 piezas mixto C-PVC / Latón.

Junta en EPDM.
H-M encolar-rosocar latón.



BIROC

d x Rh	Ref.	Pack	Pack	U/	B1	
					€ EPDM	€ FKM
16 x 3/8"	BIROC016038E	16	50	100	27,58	
20 x 1/2"	BIROC020012E	16	35	70	33,39	
25 x 3/4"	BIROC025034E	16	15	30	42,20	
32 x 1"	BIROC032100E	16	12	24	54,71	
40 x 1 1/4"	BIROC040114E	16	8	16	77,77	
50 x 1 1/2"	BIROC050112E	16	4	8	95,28	
63 x 2"	BIROC063200E	16	-	10	120,06	

Unión 3 piezas mixto C-PVC / Latón.

Junta en EPDM.
H-M encolar-rosocar latón.



INDUSTRIA

Sistema C-PVC

Válvulas de bola



VKDIC

C1

d	Ref. EPDM	DN	PN	€	
				EPDM	FKM
16	VKDIC016E	10	16	72,90	94,73
20	VKDIC020E	15	16	72,90	94,73
25	VKDIC025E	20	16	79,10	102,29
32	VKDIC032E	25	16	94,73	115,24
40	VKDIC040E	32	16	110,34	130,11
50	VKDIC050E	40	16	133,83	164,25
63	VKDIC063E	50	16	169,21	212,59

Válvula de bola DUAL BLOCK®
Asiento PTFE (teflón). Bidireccional.
H-H encolar.

Código en FKM termina en "F"
en lugar de "E"



VKDOC

C1

d	Ref. EPDM	DN	PN	€	
				EPDM	FKM
20	VKDOC020E	15	16	154,66	190,22
25	VKDOC025E	20	16	163,48	197,17
32	VKDOC032E	25	16	185,23	215,22
40	VKDOC040E	32	16	253,96	282,74
50	VKDOC050E	40	16	294,64	335,22
63	VKDOC063E	50	16	346,98	409,36

Válvula de bola DUAL BLOCK®
Asiento PTFE (teflón). Bidireccional.
Con brida loca.

Código en FKM termina en "F"
en lugar de "E"
Versión con bridas ANSI 150 lbs
al mismo precio



VKDIC

C1

d	Ref. EPDM	DN	PN	€	
				EPDM	FKM
75	VKDIC075E	65	16	495,79	641,23
90	VKDIC090E	80	16	650,46	822,50
110	VKDIC110E	100	16	784,81	956,87

Válvula de bola DUAL BLOCK®
Asiento PTFE (teflón). Bidireccional.
H-H encolar.

Código en FKM termina en "F"
en lugar de "E"



VKDOC

C1

d	Ref. EPDM	DN	PN	€	
				EPDM	FKM
75	VKDOC075E	65	16	743,66	889,12
90	VKDOC090E	80	16	975,73	1.147,77
110	VKDOC110E	100	16	1.177,22	1.349,25

Válvula de bola DUAL BLOCK®
Asiento PTFE (teflón). Bidireccional.
Con brida loca DIN y ANSI.

Código en FKM termina en "F"
en lugar de "E"



VKDDC

C1

d	Ref. EPDM	DN	PN	€ EPDM	€ FKM
20	VKDDC020E	15	16	83,80	105,70
25	VKDDC025E	20	16	90,67	107,69
32	VKDDC032E	25	16	109,04	130,71
40	VKDDC040E	32	16	126,75	146,51
50	VKDDC050E	40	16	146,51	183,32
63	VKDDC063E	50	16	190,34	236,50

Válvula de bola DUAL BLOCK®
Asiento PTFE (teflón). Bidireccional.
M-M encolar. Código en FKM termina en "F"
en lugar de "E"



VXEIC

C1

d	Ref. EPDM	DN	PN	U/ Ø	€ EPDM	€ FKM
16	VXEIC016E	10	16	100	45,34	58,81
20	VXEIC020E	15	16	80	45,34	58,81
25	VXEIC025E	20	16	40	49,07	63,45
32	VXEIC032E	25	16	28	55,49	67,54
40	VXEIC040E	32	16	16	67,51	79,60
50	VXEIC050E	40	16	8	78,15	95,91
63	VXEIC063E	50	16	12	105,70	132,88

Válvula de bola maneta naranja.
Asiento PTFE (teflón). Bidireccional.
H-H encolar. Código en FKM termina en "F"
en lugar de "E"
Disponemos de manguitos
roscados para estas válvulas



VKDDC

C1

d	Ref. EPDM	DN	PN	€ EPDM	€ FKM
75	VKDDC075E	65	16	545,33	690,82
90	VKDDC090E	80	16	715,54	887,61
110	VKDDC110E	100	16	863,27	1.035,33

Válvula de bola DUAL BLOCK®
Asiento PTFE (teflón). Bidireccional.
M-M encolar. Código en FKM termina en "F"
en lugar de "E"



VXEIC

C1

d	Ref. EPDM	DN	PN	€ EPDM	€ FKM
75	VXEIC075E	65	16	325,40	384,45
90	VXEIC090E	80	16	420,43	492,01
110	VXEIC110E	100	16	591,93	707,27

Válvula de bola maneta naranja.
Asiento PTFE (teflón). Bidireccional.
H-H encolar. Código en FKM termina en "F"
en lugar de "E"
Disponemos de manguitos
roscados para estas válvulas



TKDIC

C1

d	Ref. EPDM	DN	PN	€ EPDM	€ FKM
16	TKDIC016E	10	16	138,53	149,94
20	TKDIC020E	15	16	138,53	149,94
25	TKDIC025E	20	16	150,28	165,46
32	TKDIC032E	25	16	179,91	198,75
40	TKDIC040E	32	16	222,68	249,93
50	TKDIC050E	40	16	247,63	293,41
63	TKDIC063E	50	16	314,95	372,74

Válvula de bola 3 vías
DUAL BLOCK®. PASO T.
Asiento PTFE (teflón). H-H-H encolar. Código en FKM termina en "F"
en lugar de "E"
Disponemos de manguitos
roscados para estas válvulas



LKDIC

C1

d	Ref. EPDM	DN	PN	€ EPDM	€ FKM
16	LKDIC016E	10	16	159,33	170,71
20	LKDIC020E	15	16	159,33	170,71
25	LKDIC025E	20	16	172,82	188,01
32	LKDIC032E	25	16	206,86	225,76
40	LKDIC040E	32	16	256,06	283,33
50	LKDIC050E	40	16	284,74	330,56
63	LKDIC063E	50	16	362,21	420,00

Válvula de bola 3 vías
DUAL BLOCK®. PASO L.
Asiento PTFE (teflón). H-H-H encolar. Código en FKM termina en "F"
en lugar de "E"
Disponemos de manguitos
roscados para estas válvulas



INDUSTRIA

Sistema C-PVC

Válvulas de mariposa



FKOC/FM

d	Ref. EPDM	DN	G	
			€ EPDM	€ FKM
50	FKOCFM050E	40	263,16	390,04
63	FKOCFM063E	50	278,66	412,94
75	FKOCFM075E	65	309,61	458,86
90	FKOCFM090E	80	336,56	492,51
110	FKOCFM110E	100	365,69	527,27
125	FKOCFM140E	125	485,77	705,64
140	FKOCFM140E	125	485,77	705,64
160	FKOCFM160E	150	536,25	755,04
200	FKOCFM225E	200	694,42	979,37
225	FKOCFM225E	200	694,42	979,37
250**	FKOCFM280E	250	2.212,54	3.520,75
280**	FKOCFM280E	250	2.212,54	3.520,75
315**	FKOCFM315E	300	2.412,31	3.839,43

Válvula de mariposa industrial.

A EJE LIBRE.

Para actuar. Cuerpo en PPGR,
eje inoxidable y disco en C-PVC.

Código en FKM termina en "F"
en lugar de "E"

** ANSI 150 lbs bajo pedido
al mismo precio.



FKOC/RM

d	Ref. EPDM	DN	G	
			€ EPDM	€ FKM
75	FKOCRM075E	65	815,57	961,40
90	FKOCRM090E	80	832,40	984,95
110	FKOCRM110E	100	867,19	1.023,12
125	FKOCRM140E	125	1.002,91	1.218,30
140	FKOCRM140E	125	1.002,91	1.218,30
160	FKOCRM160E	150	1.046,69	1.246,30
200	FKOCRM225E	200	1.324,91	1.584,03
225	FKOCRM225E	200	1.324,91	1.584,03
250**	FKOCRM280E	250	2.533,46	3.841,70
280**	FKOCRM280E	250	2.533,46	3.841,70
315**	FKOCRM315E	300	2.733,15	4.160,31

Válvula de mariposa industrial.

CON VOLANTE.

Cuerpo en PPGR,
eje inoxidable y disco en C-PVC.

Código en FKM termina en "F"
en lugar de "E"

** ANSI 150 lbs bajo pedido
al mismo precio.



FKOC/LM

d	Ref. EPDM	DN	G	
			€ EPDM	€ FKM
50	FKOCLM050E	40	308,97	432,92
63	FKOCLM063E	50	327,12	458,39
75	FKOCLM075E	65	363,46	509,31
90	FKOCLM090E	80	382,53	535,09
110	FKOCLM110E	100	415,09	572,14
125	FKOCLM140E	125	551,95	767,34
140	FKOCLM140E	125	551,95	767,34
160	FKOCLM160E	150	595,70	795,39
200	FKOCLM225E	200	770,68	1.030,96
225	FKOCLM225E	200	770,68	1.030,96

Válvula de mariposa industrial.

CON MANETA.

Cuerpo en PPGR,
eje inoxidable y disco en C-PVC.

Código en FKM termina en "F"
en lugar de "E"



FKOC/FM

d	Ref. EPDM	DN	G	
			€ EPDM	€ FKM
75	FKOLCFM075E	65	448,72	597,96
90	FKOLCFM090E	80	518,31	674,23
110	FKOLCFM110E	100	563,12	724,71
125	FKOLCFM140E	125	749,36	969,25
140	FKOLCFM140E	125	749,36	969,25
160	FKOLCFM160E	150	821,18	1.039,94
200	FKOLCFM225E	200	989,46	1.274,39
225	FKOLCFM225E	200	989,46	1.274,39

Válvula de mariposa industrial.

A EJE LIBRE. LUG ISO-DIN.

Para actuar. Cuerpo en PPGR,
eje inoxidable y disco en C-PVC.

Código en FKM termina en "F"
en lugar de "E"

**FKOC/LM**

G

d	Ref. EPDM	DN	€ EPDM	€ FKM
75	FKOLCLM075E	65	502,62	648,40
90	FKOLCLM090E	80	564,26	716,84
110	FKOLCLM110E	100	612,51	769,57
125	FKOLCLM140E	125	815,57	1.030,96
140	FKOLCLM140E	125	815,57	1.030,96
160	FKOLCLM160E	150	880,67	1.080,35
200	FKOLCLM225E	200	1.065,69	1.325,98
225	FKOLCLM225E	200	1.065,69	1.325,98

Válvula de mariposa industrial.

CON MANETA. LUG ISO-DIN.

Cuerpo en PPGR,

eje *inoxidable* y disco en C-PVC.Código en FKM termina en "F"
en lugar de "E"**FKOC/RM**

G

d	Ref. EPDM	DN	€ EPDM	€ FKM
75	FKOLCRM075E	65	954,66	1.100,48
90	FKOLCRM090E	80	1.014,13	1.166,68
110	FKOLCRM110E	100	1.064,64	1.220,56
125	FKOLCRM140E	125	1.266,52	1.481,92
140	FKOLCRM140E	125	1.266,52	1.481,92
160	FKOLCRM160E	150	1.331,62	1.531,27
200	FKOLCRM225E	200	1.619,91	1.879,03
225	FKOLCRM225E	200	1.619,91	1.879,03

Válvula de mariposa industrial.

CON VOLANTE. LUG ISO-DIN.

Cuerpo en PPGR,

eje *inoxidable* y disco en C-PVC.Código en FKM termina en "F"
en lugar de "E"**FKOC/FM**

G

d	Ref. EPDM	DN	€ EPDM	€ FKM
2½"	FKOALCRM212E	65	1.024,20	1.170,09
3"	FKOALCRM300E	80	1.087,04	1.239,60
4"	FKOALCRM400E	100	1.144,27	1.300,19
5"	FKOALCRM500E	125	1.371,99	1.587,38
6"	FKOALCRM600E	150	1.446,04	1.645,71
8"	FKOALCRM800E	200	1.766,84	2.025,99
10"	FKOALCRM810E	250	3.947,86	5.256,08
12"	FKOALCRM812E	300	4.179,96	5.607,12

Válvula de mariposa industrial.

CON VOLANTE. LUG ANSI.Cuerpo en PPGR, eje *inoxidable*

y disco en C-PVC.

Código en FKM termina en "F"
en lugar de "E"**FKOC/LM**

G

d	Ref. EPDM	DN	€ EPDM	€ FKM
2½"	FKOALCLM212E	65	572,14	717,94
3"	FKOALCLM300E	80	637,19	789,78
4"	FKOALCLM400E	100	692,13	849,21
5"	FKOALCLM500E	125	921,02	1.136,44
6"	FKOALCLM600E	150	995,05	1.194,78
8"	FKOALCLM800E	200	1.212,64	1.472,92

Válvula de mariposa industrial.

CON MANETA. LUG ANSI.

Cuerpo en PPGR,

eje *inoxidable* y disco en C-PVC.Código en FKM termina en "F"
en lugar de "E"



INDUSTRIA

Sistema C-PVC

Válvulas de membrana



DKDC

D1

d	Ref. EPDM	DN	PN	€ EPDM	€ FKM	€ PTFE
20	DKDC020E	15	10	105,25	199,32	199,32
25	DKDC025E	20	10	117,99	217,60	217,60
32	DKDC032E	25	10	137,64	233,08	233,08
40	DKDC040E	32	10	164,35	308,87	308,87
50	DKDC050E	40	10	210,66	353,79	353,79
63	DKDC063E	50	10	251,32	488,57	447,90
75	DKDC075E	65	10	301,59	586,28	537,48

Válvula de membrana
DIALOCK®.
M-M encolar.

Código en FKM termina en "F"
en lugar de "E"
Código en PTFE termina en "P"
en lugar de "E"



DKOC

D1

d	Ref. EPDM	DN	PN	€ EPDM	€ FKM	€ PTFE
20	DKOC020E	15	10	179,91	273,95	273,95
25	DKOC025E	20	10	196,09	295,71	295,71
32	DKOC032E	25	10	218,97	314,39	314,39
40	DKOC040E	32	10	271,06	415,64	415,64
50	DKOC050E	40	10	322,49	465,66	465,66
63	DKOC063E	50	10	405,73	602,27	602,27
75	DKOC075E	65	10	527,46	782,94	782,94

Válvula de membrana
© DIALOCK .
Con bridas DIN.

Código en FKM termina en "F"
en lugar de "E"
Código en PTFE termina en "P"
en lugar de "E"



VMDC

D1

d	Ref. EPDM	DN	€ EPDM	€ FKM	€ PTFE
90	VMDC090E	80	676,67	1.207,38	935,03
110	VMDC110E	100	957,44	1.881,24	1.276,11

Válvula de membrana
M-M encolar.

Código en FKM termina en "F"
en lugar de "E"
Código en PTFE termina en "P"
en lugar de "E"



VMOC

D1

d	Ref. EPDM	DN	€ EPDM	€ FKM	€ PTFE
90	VMOC090E	80	903,88	1.434,62	1.162,27
110	VMOC110E	100	1.223,81	2.147,62	1.542,52

Válvula de membrana
Con bridas DIN. Bajo pedido
con bridas ANSI 150 lbs
al mismo precio

Código en FKM termina en "F"
en lugar de "E"
Código en PTFE termina en "P"
en lugar de "E"



DKUIC

D1

d	Ref. EPDM	DN	PN	€ EPDM	€ FKM	€ PTFE
20	DKUIC020E	15	10	119,35	213,42	213,42
25	DKUIC025E	20	10	133,38	233,08	233,08
32	DKUIC032E	25	10	154,49	249,93	249,93
40	DKUIC040E	32	10	190,91	335,53	335,53
50	DKUIC050E	40	10	238,75	381,86	381,86
63	DKUIC063E	50	10	294,86	532,10	491,45

Válvula de membrana
DIALOCK®.
Con enlaces H-H para encolar.

Código en FKM termina en "F"
en lugar de "E"
Código en PTFE termina en "P"
en lugar de "E"



DKUFC

D1

Rh	Ref. EPDM	DN	PN	€ EPDM	€ FKM	€ PTFE
½"	DKUFC012E	15	10	130,59	225,43	223,44
¾"	DKUFC034E	20	10	144,66	246,88	243,18
1"	DKUFC100E	25	10	165,10	258,93	259,60
1¼"	DKUFC114E	32	10	225,65	370,58	365,03
1½"	DKUFC112E	40	10	275,87	417,42	415,85
2"	DKUFC200E	50	10	330,24	568,47	523,87

Válvula de membrana
DIALOCK®.

Con enlaces H-H para rosacar.

Código en FKM termina en "F"
en lugar de "E"

Código en PTFE termina en "P"
en lugar de "E"



DKOAC

D1

d	Ref. EPDM	DN	PN	€ EPDM	€ FKM	€ PTFE
½"	DKOAC012E	15	10	179,91	273,95	273,95
¾"	DKOAC034E	20	10	196,09	295,71	295,71
1"	DKOAC100E	25	10	218,97	314,39	314,39
1¼"	DKOAC114E	32	10	271,06	415,64	415,64
1½"	DKOAC112E	40	10	322,49	465,66	465,66
2"	DKOAC200E	50	10	405,73	642,95	602,27
2½"	DKOAC212E	65	10	527,46	835,82	782,94

Válvula de membrana
DIALOCK®.

Con bridas ANSI 150 lbs.

Código en FKM termina en "F"
en lugar de "E"

Código en PTFE termina en "P"
en lugar de "E"



RVUIC

C1

d	Ref. EPDM	DN	PN	€ EPDM	€ FKM
20	RVUIC020E	15	16	95,57	109,92
25	RVUIC025E	20	16	103,24	121,01
32	RVUIC032E	25	16	135,78	156,39
40	RVUIC040E	32	16	155,33	193,74
50	RVUIC050E	40	16	196,72	228,52
63	RVUIC063E	50	16	256,61	287,95

Filtro inclinado.

Juntas en EPDM o FKM.

H-H con enlaces para encolar.

Código en FKM termina en "F"
en lugar de "E"



CMDC

M-M encolar

CMUIC

H-H enlaces encolar

D1

d	Ref. EPDM	DN	€ EPDM	€ FKM	€ PTFE
20	CMDC020E	15	146,04	203,58	220,24
20	CMUIC020E	15	168,48	216,24	224,62

Válvula de membrana
compacta

Código en FKM termina en "F"
en lugar de "E"
Código en PTFE termina en "P"
en lugar de "E"



SETFLOC

C1

d DIN	d ANSI	Ref. DIN	€ DIN 2501	€ ANSI
20	½"	SETFLOC020	45,65	45,65
25	¾"	SETFLOC025	52,30	52,30
32	1"	SETFLOC032	62,25	62,25
40	1¼"	SETFLOC040	78,26	78,26
50	1½"	SETFLOC050	84,42	84,42
63	2"	SETFLOC063	107,23	107,23
75	2½"	SETFLOC075	149,15	
90	3"	SETFLOC090	219,29	
110	4"	SETFLOC110	275,23	

Set embrizado.

Compuesto por 1 brida, 1 anillo fijación y 1 tuerca.

Para Válvulas VKD / TKD / RVU.

d. 75-90-110,
es el mismo art culo
para DIN y ANSI



INDUSTRIA

Sistema C-PVC

Válvulas anti-retorno con muelle



SSEIC

C1

d	Ref. EPDM	DN	PN	Pack	U/	€	
						EPDM	FKM
16	SSEIC016E	10	16	2	30	71,72	73,59
20	SSEIC020E	15	16	2	30	71,72	73,59
25	SSEIC025E	20	16	2	30	77,62	79,44
32	SSEIC032E	25	16	2	20	93,47	95,04
40	SSEIC040E	32	16	2	14	106,77	115,37
50	SSEIC050E	40	16	2	6	145,36	154,48
63	SSEIC063E	50	16	2	6	175,05	180,28
75	SSEIC075E	65	16	-	1	485,67	509,59
90	SSEIC090E	80	16	-	1	627,44	654,83
110	SSEIC110E	100	16	-	1	1.177,94	1.235,85

Válvula de retención con muelle en INOX 316.

Juntas en EPDM o FKM. H-H encolar.

Código en FKM termina en "F" en lugar de "E"



SSEAC

C1

d	Ref. EPDM	DN	PN	Pack	U/	€	
						EPDM	FKM
1/2"	SSEAC012E	10	16	2	30	71,73	73,58
3/4"	SSEAC034E	15	16	2	30	77,62	79,43
1"	SSEAC100E	20	16	2	30	93,47	95,04
1 1/4"	SSEAC114E	25	16	2	20	106,78	115,36
1 1/2"	SSEAC112E	32	16	2	14	145,36	154,48
2"	SSEAC200E	40	16	2	6	175,05	180,28
2 1/2"	SSEAC212E	50	16	2	6	485,67	509,59
3"	SSEAC300E	65	16	-	1	627,44	654,82
4"	SSEAC400E	80	16	-	1	1.177,93	1.235,83

Válvula de retención con muelle en INOX 316. H-H encolar serie ASTM.

Juntas en EPDM o FKM.

Código en FKM termina en "F" en lugar de "E"



SSEIC

C1

d	Ref. EPDM	DN	PN	Pack	U/	€	
						EPDM	FKM
16	SSEIC016EH	10	16	2	30	Consultar	Consultar
20	SSEIC020EH	15	16	2	30	Consultar	Consultar
25	SSEIC025EH	20	16	2	30	Consultar	Consultar
32	SSEIC032EH	25	16	2	20	Consultar	Consultar

Válvula de retención con muelle en HASTELLOY

Juntas en EPDM o FKM. H-H encolar.

Código en FKM termina en "F" en lugar de "E"



SSEAC

C1

d	Ref. EPDM	DN	PN	Pack	U/	€	
						EPDM	FKM
1/2"	SSEAC012EH	15	16	2	30	Consultar	Consultar
3/4"	SSEAC034EH	20	16	2	30	Consultar	Consultar
1"	SSEAC100EH	25	16	2	30	Consultar	Consultar

Válvula de retención con muelle en HASTELLOY H-H encolar serie ASTM.

Juntas en EPDM o FKM.

Código en FKM termina en "F" en lugar de "E"



SSEIC

C1

d	Ref. EPDM	DN	PN	Pack	U/	€	
						EPDM	FKM
40	SSEIC040E0P	32	16	2	2	Consultar	Consultar
50	SSEIC050E0P	40	16	2	2	Consultar	Consultar
63	SSEIC063E0P	50	16	2	2	Consultar	Consultar
75	SSEIC075E0P	65	16	-	1	Consultar	Consultar
90	SSEIC090E0P	80	16	-	1	Consultar	Consultar
110	SSEIC110E0P	100	16	-	1	Consultar	Consultar

Válvula de retención con muelle en INOX recubierto PTFE.

Juntas en EPDM o FKM. H-H encolar.

Código en FKM termina en "F" en lugar de "E"



SSEAC

C1

d	Ref. EPDM	DN	PN	Pack	U/	€	
						EPDM	FKM
1 1/4"	SSEAC114E0P	32	16	2	2	Consultar	Consultar
1 1/2"	SSEAC112E0P	40	16	2	2	Consultar	Consultar
2"	SSEAC200E0P	50	16	2	2	Consultar	Consultar
2 1/2"	SSEAC212E0P	65	16	-	1	Consultar	Consultar
3"	SSEAC300E0P	80	16	-	1	Consultar	Consultar
4"	SSEAC400E0P	100	16	-	1	Consultar	Consultar

Válvula de retención con muelle en INOX recubierto PTFE.

Juntas en EPDM o FKM. H-H encolar.

Código en FKM termina en "F" en lugar de "E"



INDUSTRIA

Sistema C-PVC

Válvulas de bola actuadas



VKDIC/CE

Encolar

K

ACTUACIÓN ELÉCTRICA

ACTUACIÓN ELÉCTRICA CON BLOQUE DE SEGURIDAD

d	24-240 V AC/DC		24-240 V AC/DC		24-240 V AC/DC		24-240 V AC/DC	
	Ref.	€ EPDM	Ref.	€ FKM	Ref.	€ EPDM	Ref.	€ FKM
16	VKCE016E2D	780,71	VKCE016F2D	814,66	VKCE016E2BD	1.414,27	VKCE016F2BD	1.448,21
20	VKCE020E2D	780,71	VKCE020F2D	814,66	VKCE020E2BD	1.414,27	VKCE020F2BD	1.448,21
25	VKCE025E2D	793,61	VKCE025F2D	829,73	VKCE025E2BD	1.427,16	VKCE025F2BD	1.463,26
32	VKCE032E2D	817,97	VKCE032F2D	849,81	VKCE032E2BD	1.451,50	VKCE032F2BD	1.483,37
40	VKCE040E2D	850,46	VKCE040F2D	881,28	VKCE040E2BD	1.484,03	VKCE040F2BD	1.514,85
50	VKCE050E2D	887,08	VKCE050F2D	934,36	VKCE050E2BD	1.520,59	VKCE050F2BD	1.567,92
63	VKCE063E2D	946,12	VKCE063F2D	1.013,68	VKCE063E2BD	1.579,68	VKCE063F2BD	1.647,22
75	VKCE075E2D	1.681,44	VKCE075F2D	1.907,85	VKCE075E2BD	2.315,00	VKCE075F2BD	2.541,39
90	VKCE090E2D	1.922,18	VKCE090F2D	2.189,95	VKCE090E2BD	2.555,71	VKCE090F2BD	2.823,49
110	VKCE110E2D	2.562,64	VKCE110F2D	2.830,44	VKCE110E2BD	3.196,21	VKCE110F2BD	3.464,00

Válvula de bola motorizada en C-PVC 2 vías DUAL BLOCK®. Actuación eléctrica

Disponemos de otras conexiones bajo pedido: bridas, encolar macho y roscar (GAS,NPT) Bajo pedido podemos suministrar otros actuadores: VALPES, BELIMO... Bajo pedido también disponibles en 12V AC/DC

VKDIC/CP

Encolar

K

ACTUACIÓN NEUMÁTICA ALUMINIO

ACTUACIÓN NEUMÁTICA ALUMINIO CON ELECTROVÁLVULA, FINALES DE CARRERA (ELECTROMECÁNICOS) Y REGULADORES DE ESCAPE

d	DOBLE EFECTO		SIMPLE EFECTO		DOBLE EFECTO		SIMPLE EFECTO	
	Ref.	€ EPDM	Ref.	€ FKM	Ref.	€ EPDM	Ref.	€ FKM
16	VKCP016EDED	395,36	VKCP016ESED	430,43	VKCP016EDEFD	624,54	VKCP016ESEFD	671,73
20	VKCP020EDED	395,36	VKCP020ESED	430,43	VKCP020EDEFD	624,54	VKCP020ESEFD	671,73
25	VKCP025EDED	408,24	VKCP025ESED	443,32	VKCP025EDEFD	637,40	VKCP025ESEFD	684,58
32	VKCP032EDED	432,61	VKCP032ESED	467,66	VKCP032EDEFD	661,75	VKCP032ESEFD	708,93
40	VKCP040EDED	465,10	VKCP040ESED	500,19	VKCP040EDEFD	694,26	VKCP040ESEFD	741,44
50	VKCP050EDED	501,69	VKCP050ESED	604,89	VKCP050EDEFD	730,86	VKCP050ESEFD	846,15
63	VKCP063EDED	560,80	VKCP063ESED	754,08	VKCP063EDEFD	789,94	VKCP063ESEFD	995,35
75	VKCP075EDED	1.111,81	VKCP075ESED	1.248,58	VKCP075EDEFD	1.340,98	VKCP075ESEFD	1.489,85
90	VKCP090EDED	1.352,56	VKCP090ESED	1.489,31	VKCP090EDEFD	1.581,72	VKCP090ESEFD	1.730,59
110	VKCP110EDED	1.592,50	VKCP110ESED	2.076,55	VKCP110EDEFD	1.821,67	VKCP110ESEFD	2.317,79
16	VKCP016FDED	429,31	VKCP016FSED	464,40	VKCP016FDEFD	658,48	VKCP016FSEFD	705,65
20	VKCP020FDED	429,31	VKCP020FSED	464,40	VKCP020FDEFD	658,48	VKCP020FSEFD	705,65
25	VKCP025FDED	444,38	VKCP025FSED	479,43	VKCP025FDEFD	673,51	VKCP025FSEFD	720,72
32	VKCP032FDED	464,45	VKCP032FSED	499,53	VKCP032FDEFD	693,62	VKCP032FSEFD	740,79
40	VKCP040FDED	495,94	VKCP040FSED	531,00	VKCP040FDEFD	725,12	VKCP040FSEFD	772,25
50	VKCP050FDED	549,01	VKCP050FSED	652,21	VKCP050FDEFD	778,16	VKCP050FSEFD	893,49
63	VKCP063FDED	628,32	VKCP063FSED	821,61	VKCP063FDEFD	857,47	VKCP063FSEFD	1.062,87
75	VKCP075FDED	1.338,21	VKCP075FSED	1.474,97	VKCP075FDEFD	1.567,38	VKCP075FSEFD	1.716,25
90	VKCP090FDED	1.620,31	VKCP090FSED	1.757,08	VKCP090FDEFD	1.849,49	VKCP090FSEFD	1.998,34
110	VKCP110FDED	1.860,29	VKCP110FSED	2.344,32	VKCP110FDEFD	2.089,43	VKCP110FSEFD	2.585,55

Válvula de bola motorizada en C-PVC 2 vías DUAL BLOCK®. Actuación eléctrica.

Disponemos de otras conexiones bajo pedido: bridas, encolar macho y roscar (GAS,NPT) Las válvulas neumáticas se configuran NC (normalmente cerrada) de serie. La configuración NA (normalmente abierta) se debe especificar en el pedido

VKDIC/CP

Encolar



K

ACTUACIÓN NEUMÁTICA POLIAMIDA

ACTUACIÓN NEUMÁTICA POLIAMIDA CON ELECTROVÁLVULA, FINALES DE CARRERA (ELECTROMECAÑICOS) Y REGULADORES DE ESCAPE

d	DOBLE EFECTO		SIMPLE EFECTO		DOBLE EFECTO		SIMPLE EFECTO	
	Ref.	€ EPDM	Ref	€ FKM	Ref.	€ EPDM	Ref.	€ FKM
16	VKCP016EDEP	416,74	VKCP016ESEP	443,17	VKCP016EDEFPP	716,51	VKCP016ESEFP	742,95
20	VKCP020EDEP	416,74	VKCP020ESEP	443,17	VKCP020EDEFPP	716,51	VKCP020ESEFP	742,95
25	VKCP025EDEP	429,66	VKCP025ESEP	456,09	VKCP025EDEFPP	729,41	VKCP025ESEFP	755,84
32	VKCP032EDEP	453,98	VKCP032ESEP	599,36	VKCP032EDEFPP	753,73	VKCP032ESEFP	899,08
40	VKCP040EDEP	486,51	VKCP040ESEP	631,83	VKCP040EDEFPP	786,27	VKCP040ESEFP	931,60
50	VKCP050EDEP	523,10	VKCP050ESEP	807,14	VKCP050EDEFPP	822,87	VKCP050ESEFP	1.106,88
63	VKCP063EDEP	815,27	VKCP063ESEP	891,23	VKCP063EDEFPP	1.115,04	VKCP063ESEFP	1.191,00
75	VKCP075EDEP	1.259,20	VKCP075ESEP	1.543,76	VKCP075EDEFPP	1.558,95	VKCP075ESEFP	1.843,54
90	VKCP090EDEP	1.499,93	VKCP090ESEP	1.784,50	VKCP090EDEFPP	1.799,69	VKCP090ESEFP	2.084,28
110	VKCP110EDEP	1.701,72	VKCP110ESEP	2.010,57	VKCP110EDEFPP	2.001,48	VKCP110ESEFP	2.310,34

16	VKCP016FDEP	450,73	VKCP016FSEP	477,17	VKCP016FDEFPP	750,47	VKCP016FSEFP	776,91
20	VKCP020FDEP	450,73	VKCP020FSEP	477,17	VKCP020FDEFPP	750,47	VKCP020FSEFP	776,91
25	VKCP025FDEP	465,78	VKCP025FSEP	492,20	VKCP025FDEFPP	765,54	VKCP025FSEFP	791,95
32	VKCP032FDEP	485,85	VKCP032FSEP	631,20	VKCP032FDEFPP	785,63	VKCP032FSEFP	930,94
40	VKCP040FDEP	517,32	VKCP040FSEP	662,68	VKCP040FDEFPP	817,10	VKCP040FSEFP	962,43
50	VKCP050FDEP	570,39	VKCP050FSEP	854,47	VKCP050FDEFPP	870,16	VKCP050FSEFP	1.154,23
63	VKCP063FDEP	882,80	VKCP063FSEP	958,75	VKCP063FDEFPP	1.182,55	VKCP063FSEFP	1.258,52
75	VKCP075FDEP	1.485,59	VKCP075FSEP	1.770,16	VKCP075FDEFPP	1.785,34	VKCP075FSEFP	2.069,93
90	VKCP090FDEP	1.767,69	VKCP090FSEP	2.052,26	VKCP090FDEFPP	2.067,44	VKCP090FSEFP	2.352,00
110	VKCP110FDEP	1.969,46	VKCP110FSEP	2.278,33	VKCP110FDEFPP	2.269,24	VKCP110FSEFP	2.578,10

Válvula de bola motorizada en C-PVC 2 vías DUAL BLOCK®. Actuación eléctrica.

Disponemos de otras conexiones bajo pedido: bridas, encolar macho y roscar (GAS, NPT)
Las válvulas neumáticas se configuran NC (normalmente cerrada) de serie.
La configuración NA (normalmente abierta) se debe especificar en el pedido



INDUSTRIA

Sistema C-PVC

Válvulas de 3 vías actuadas



LKDIC/CE

Encolar

K

ACTUACIÓN ELÉCTRICA

ACTUACIÓN ELÉCTRICA CON BLOQUE DE SEGURIDAD

d	24-240 V AC/DC		24-240 V AC/DC		24-240 V AC/DC		24-240 V AC/DC	
	Ref.	€ EPDM	Ref.	€ FKM	Ref.	€ EPDM	Ref.	€ FKM
16	LKCE016E2D	915,18	LKCE016F2D	932,93	LKCE016E2BD	1.548,74	LKCE016F2BD	1.566,46
20	LKCE020E2D	915,18	LKCE020F2D	932,93	LKCE020E2BD	1.548,74	LKCE020F2BD	1.566,46
25	LKCE025E2D	939,47	LKCE025F2D	963,14	LKCE025E2BD	1.573,03	LKCE025F2BD	1.596,71
32	LKCE032E2D	992,46	LKCE032F2D	1.021,88	LKCE032E2BD	1.626,01	LKCE032F2BD	1.655,39
40	LKCE040E2D	1.077,27	LKCE040F2D	1.119,75	LKCE040E2BD	1.710,80	LKCE040F2BD	1.753,30
50	LKCE050E2D	1.121,88	LKCE050F2D	1.193,23	LKCE050E2BD	1.755,45	LKCE050F2BD	1.826,77
63	LKCE063E2D	1.246,58	LKCE063F2D	1.336,47	LKCE063E2BD	1.880,08	LKCE063F2BD	1.970,00

Válvula de bola motorizada en C-PVC 3 vías DUAL BLOCK®. Actuación eléctrica

Estándar paso en L, paso en T opcional, al mismo precio. Disponemos de otras conexiones bajo pedido: bridas, encolar macho y roscar (GAS, NPT) Bajo pedido podemos suministrar otros actuadores: VALPES, BELIMO...

Bajo pedido también disponibles en 12V AC/DC

LKDIC/CP

Encolar

K

ACTUACIÓN NEUMÁTICA ALUMINIO

ACTUACIÓN NEUMÁTICA ALUMINIO CON ELECTROVÁLVULA, FINALES DE CARRERA (ELECTROMEQUÍNICOS) Y REGULADORES DE ESCAPE

d	DOBLE EFECTO		SIMPLE EFECTO		DOBLE EFECTO		SIMPLE EFECTO	
	Ref.	€ EPDM	Ref.	€ FKM	Ref.	€ EPDM	Ref.	€ FKM
16	LKCP016EDED	529,82	LKCP016ESED	564,91	LKCP016EDEFD	759,01	LKCP016ESEFD	806,16
20	LKCP020EDED	529,82	LKCP020ESED	564,91	LKCP020EDEFD	759,01	LKCP020ESEFD	806,16
25	LKCP025EDED	554,11	LKCP025ESED	589,20	LKCP025EDEFD	783,28	LKCP025ESEFD	830,46
32	LKCP032EDED	607,10	LKCP032ESED	642,20	LKCP032EDEFD	836,27	LKCP032ESEFD	883,45
40	LKCP040EDED	691,94	LKCP040ESED	795,12	LKCP040EDEFD	921,08	LKCP040ESEFD	1.036,36
50	LKCP050EDED	777,40	LKCP050ESED	929,85	LKCP050EDEFD	1.006,54	LKCP050ESEFD	1.171,10
63	LKCP063EDED	902,04	LKCP063ESED	1.054,48	LKCP063EDEFD	1.131,18	LKCP063ESEFD	1.295,75
16	LKCP016FDED	547,57	LKCP016FSED	582,63	LKCP016FDEFD	776,71	LKCP016FSEFD	823,91
20	LKCP020FDED	547,57	LKCP020FSED	582,63	LKCP020FDEFD	776,71	LKCP020FSEFD	823,91
25	LKCP025FDED	577,79	LKCP025FSED	612,88	LKCP025FDEFD	806,96	LKCP025FSEFD	854,14
32	LKCP032FDED	636,51	LKCP032FSED	671,57	LKCP032FDEFD	865,65	LKCP032FSEFD	912,84
40	LKCP040FDED	734,37	LKCP040FSED	837,58	LKCP040FDEFD	963,54	LKCP040FSEFD	1.078,85
50	LKCP050FDED	848,72	LKCP050FSED	1.001,17	LKCP050FDEFD	1.077,87	LKCP050FSEFD	1.242,46
63	LKCP063FDED	991,92	LKCP063FSED	1.144,43	LKCP063FDEFD	1.221,10	LKCP063FSEFD	1.385,68

Válvula de bola motorizada en C-PVC 3 vías DUAL BLOCK®. Actuación neumática

Estándar paso en L, paso en T opcional, al mismo precio. Disponemos de otras conexiones bajo pedido: bridas, encolar macho y roscar (GAS, NPT) Las válvulas neumáticas se configuran NC (normalmente cerrada) de serie. La configuración NA (normalmente abierta) se debe especificar en el pedido

LKDIC/CP

Encolar



K

ACTUACIÓN NEUMÁTICA POLIAMIDA

ACTUACIÓN NEUMÁTICA POLIAMIDA CON ELECTROVÁLVULA, FINALES DE CARRERA (ELECTROMECAÑICOS) Y REGULADORES DE ESCAPE

d	DOBLE EFECTO		SIMPLE EFECTO		DOBLE EFECTO		SIMPLE EFECTO	
	Ref.	€ EPDM	Ref.	€ FKM	Ref.	€ EPDM	Ref.	€ FKM
16	LKCP016EDEP	596,25	LKCP016ESEP	622,68	LKCP016EDEFPP	896,02	LKCP016ESEFP	922,44
20	LKCP020EDEP	596,25	LKCP020ESEP	622,68	LKCP020EDEFPP	896,02	LKCP020ESEFP	922,44
25	LKCP025EDEP	672,16	LKCP025ESEP	698,58	LKCP025EDEFPP	971,90	LKCP025ESEFP	998,34
32	LKCP032EDEP	725,18	LKCP032ESEP	870,49	LKCP032EDEFPP	1.024,92	LKCP032ESEFP	1.170,26
40	LKCP040EDEP	826,99	LKCP040ESEP	1.111,03	LKCP040EDEFPP	1.126,74	LKCP040ESEFP	1.410,80
50	LKCP050EDEP	977,82	LKCP050ESEP	1.152,85	LKCP050EDEFPP	1.277,56	LKCP050ESEFP	1.452,61
63	LKCP063EDEP	1.189,44	LKCP063ESEP	1.265,42	LKCP063EDEFPP	1.489,17	LKCP063ESEFP	1.565,17

d	DOBLE EFECTO		SIMPLE EFECTO		DOBLE EFECTO		SIMPLE EFECTO	
	Ref.	€ EPDM	Ref.	€ FKM	Ref.	€ EPDM	Ref.	€ FKM
16	LKCP016FDEP	613,97	LKCP016FSEP	640,41	LKCP016FDEFPP	913,74	LKCP016FSEFP	940,16
20	LKCP020FDEP	613,97	LKCP020FSEP	640,41	LKCP020FDEFPP	913,74	LKCP020FSEFP	940,16
25	LKCP025FDEP	695,83	LKCP025FSEP	722,28	LKCP025FDEFPP	995,62	LKCP025FSEFP	1.022,06
32	LKCP032FDEP	754,53	LKCP032FSEP	899,87	LKCP032FDEFPP	1.054,29	LKCP032FSEFP	1.199,64
40	LKCP040FDEP	869,47	LKCP040FSEP	1.153,52	LKCP040FDEFPP	1.169,22	LKCP040FSEFP	1.453,28
50	LKCP050FDEP	1.049,12	LKCP050FSEP	1.224,18	LKCP050FDEFPP	1.348,90	LKCP050FSEFP	1.523,93
63	LKCP063FDEP	1.279,34	LKCP063FSEP	1.355,32	LKCP063FDEFPP	1.579,11	LKCP063FSEFP	1.655,07

Válvula de bola motorizada en C-PVC 3 vías DUAL BLOCK®. Actuación neumática.

Estándar paso en L, paso en T opcional, al mismo precio. Disponemos de otras conexiones bajo pedido: bridas, encolar macho y roscar (GAS, NPT). Las válvulas neumáticas se configuran NC (normalmente cerrada) de serie. La configuración NA (normalmente abierta) se debe especificar en el pedido.

FKOC/CE

ACTUACIÓN ELÉCTRICA

ACTUACIÓN ELÉCTRICA CON BLOQUE DE SEGURIDAD

d	24-240 V AC/DC		24-240 V AC/DC		24-240 V AC/DC		24-240 V AC/DC	
	Ref.	€ EPDM	Ref.	€ FKM	Ref.	€ EPDM	Ref.	€ FKM
50	FKCE050E2D	1.015,87	FKCE050F2D	1.203,44	FKCE050E2BD	1.649,46	FKCE050F2BD	1.836,99
63	FKCE063E2D	1.038,80	FKCE063F2D	1.237,26	FKCE063E2BD	1.672,34	FKCE063F2BD	1.870,82
75	FKCE075E2D	1.381,09	FKCE075F2D	1.601,73	FKCE075E2BD	2.014,66	FKCE075F2BD	2.235,32
90	FKCE090E2D	1.420,97	FKCE090F2D	1.651,40	FKCE090E2BD	2.054,50	FKCE090F2BD	2.284,95
110	FKCE110E2D	1.464,00	FKCE110F2D	1.702,83	FKCE110E2BD	2.097,54	FKCE110F2BD	2.336,38
125	FKCE140E2D	2.059,40	FKCE140F2D	2.384,43	FKCE140E2BD	2.692,94	FKCE140F2BD	3.017,96
140	FKCE140E2D	2.059,40	FKCE140F2D	2.384,43	FKCE140E2BD	2.692,94	FKCE140F2BD	3.017,96
160	FKCE160E2D	2.410,33	FKCE160F2D	2.733,78	FKCE160E2BD	3.151,74	FKCE160F2BD	3.475,16
200 - 225	FKCE225E2D	2.808,52	FKCE225F2D	3.229,72	FKCE225E2BD	3.549,90	FKCE225F2BD	3.971,11
250	FKCE280E2D	5.137,89	FKCE280F2D	7.071,93	FKCE280E2BD	5.879,30	FKCE280F2BD	7.813,32
280	FKCE280E2D	5.137,89	FKCE280F2D	7.071,93	FKCE280E2BD	5.879,30	FKCE280F2BD	7.813,32
315	FKCE315E2D	5.433,22	FKCE315F2D	7.543,06	FKCE315E2BD	6.174,60	FKCE315F2BD	8.284,46

Válvula de mariposa industrial motorizada cuerpo en PPGR y disco en C-PVC. Actuación eléctrica.

Bajo pedido podemos suministrar otros actuadores: VALPES, BELIMO...
Bajo pedido también disponibles en 12V AC/DC



INDUSTRIA

Sistema C-PVC

Válvulas de mariposa actuadas



K

FKOC/CP

ACTUACIÓN NEUMÁTICA ALUMINIO

ACTUACIÓN NEUMÁTICA ALUMINIO CON ELECTROVÁLVULA, FINALES DE CARRERA (ELECTROMECAÑICOS) Y REGULADORES DE ESCAPE

d	DOBLE EFECTO		SIMPLE EFECTO		DOBLE EFECTO		DOBLE EFECTO	
	Ref.	€	Ref	€	Ref.	€	Ref.	€
50	FKCP050EDED	630,15	FKCP050ESED	733,34	FKCP050EDEFD	859,31	FKCP050ESEFD	974,60
63	FKCP063EDED	653,06	FKCP063ESED	756,25	FKCP063EDEFD	882,20	FKCP063ESEFD	997,51
75	FKCP075EDED	739,64	FKCP075ESED	892,09	FKCP075EDEFD	968,77	FKCP075ESEFD	1.133,34
90	FKCP090EDED	850,92	FKCP090ESED	987,70	FKCP090EDEFD	1.080,08	FKCP090ESEFD	1.228,97
110	FKCP110EDED	893,99	FKCP110ESED	1.408,85	FKCP110EDEFD	1.123,16	FKCP110ESEFD	1.650,11
125	FKCP140EDED	1.108,86	FKCP140ESED	1.882,61	FKCP140EDEFD	1.338,04	FKCP140ESEFD	2.123,86
140	FKCP140EDED	1.108,86	FKCP140ESED	1.882,61	FKCP140EDEFD	1.338,04	FKCP140ESEFD	2.123,86
160	FKCP160EDED	1.183,47	FKCP160ESED	1.957,17	FKCP160EDEFD	1.412,61	FKCP160ESEFD	2.198,44
200 - 225	FKCP225EDED	1.740,35	FKCP225ESED	2.802,25	FKCP225EDEFD	1.969,46	FKCP225ESEFD	3.043,47
250	FKCP280EDED	4.276,35	FKCP280ESED	6.527,61	FKCP280EDEFD	4.505,53	FKCP280ESEFD	6.768,87
280	FKCP280EDED	4.276,35	FKCP280ESED	6.527,61	FKCP280EDEFD	4.505,53	FKCP280ESEFD	6.768,87
315	FKCP315EDED	4.877,86	FKCP315ESED	7.985,95	FKCP315EDEFD	5.107,01	FKCP315ESEFD	8.227,17
50	FKCP050FDED	817,68	FKCP050FSED	920,87	FKCP050FDEFD	1.046,86	FKCP050FSEFD	1.162,15
63	FKCP063FDED	851,51	FKCP063FSED	954,72	FKCP063FDEFD	1.080,67	FKCP063FSEFD	1.195,97
75	FKCP075FDED	960,27	FKCP075FSED	1.112,73	FKCP075FDEFD	1.189,44	FKCP075FSEFD	1.354,01
90	FKCP090FDED	1.081,39	FKCP090FSED	1.218,16	FKCP090FDEFD	1.310,54	FKCP090FSEFD	1.459,41
110	FKCP110FDED	1.132,81	FKCP110FSED	1.647,70	FKCP110FDEFD	1.361,97	FKCP110FSEFD	1.888,95
125	FKCP140FDED	1.433,91	FKCP140FSED	2.207,62	FKCP140FDEFD	1.663,06	FKCP140FSEFD	2.448,88
140	FKCP140FDED	1.433,91	FKCP140FSED	2.207,62	FKCP140FDEFD	1.663,06	FKCP140FSEFD	2.448,88
160*	FKCP160FDED	1.506,92	FKCP160FSED	2.280,64	FKCP160FDEFD	1.736,10	FKCP160FSEFD	2.521,91
200 - 225	FKCP225FDED	2.161,56	FKCP225FSED	3.223,43	FKCP225FDEFD	2.390,71	FKCP225FSEFD	3.464,69
250	FKCP280FDED	6.210,38	FKCP280FSED	8.461,63	FKCP280FDEFD	6.439,54	FKCP280FSEFD	8.702,92
280	FKCP280FDED	6.210,38	FKCP280FSED	8.461,63	FKCP280FDEFD	6.439,54	FKCP280FSEFD	8.702,92
315	FKCP315FDED	6.987,69	FKCP315FSED	10.095,78	FKCP315FDEFD	7.216,86	FKCP315FSEFD	10.337,05

Válvula de mariposa industrial motorizada
cuerpo en PPGR y disco en C-PVC
Actuación neumática.

Las válvulas neumáticas se configuran NC (normalmente cerrada) de serie.
La configuración NA (normalmente abierta) se debe especificar en el pedido



FKOC/CP

K

ACTUACIÓN NEUMÁTICA POLIAMIDA

ACTUACIÓN NEUMÁTICA POLIAMIDA CON ELECTROVÁLVULA, FINALES DE CARRERA (ELECTROMECAÑICOS) Y REGULADORES DE ESCAPE

d	DOBLE EFECTO		SIMPLE EFECTO		DOBLE EFECTO		DOBLE EFECTO	
	Ref.	€	Ref.	€	Ref.	€	Ref.	€
50	FKCP050EDEP	752,33	FKCP050ESEP	938,68	FKCP050EDEFD	1.052,07	FKCP050ESEFP	1.238,44
63	FKCP063EDEP	775,20	FKCP063ESEP	961,58	FKCP063EDEFD	1.074,98	FKCP063ESEFP	1.261,34
75	FKCP075EDEP	820,96	FKCP075ESEP	1.007,32	FKCP075EDEFD	1.120,74	FKCP075ESEFP	1.307,09
90	FKCP090EDEP	970,80	FKCP090ESEP	1.046,79	FKCP090EDEFD	1.270,58	FKCP090ESEFP	1.346,53
110	FKCP110EDEP	1.013,87	FKCP110ESEP	1.312,82	FKCP110EDEFD	1.313,63	FKCP110ESEFP	1.612,59
125	FKCP140EDEP	1.181,58	FKCP140ESEP	1.823,37	FKCP140EDEFD	1.481,34	FKCP140ESEFP	2.123,12
140	FKCP140EDEP	1.181,58	FKCP140ESEP	1.823,37	FKCP140EDEFD	1.481,34	FKCP140ESEFP	2.123,12
160	FKCP160EDEP	1.465,89	FKCP160ESEP	1.897,98	FKCP160EDEFD	1.765,64	FKCP160ESEFP	2.197,74
200	FKCP225EDEP	1.719,08	FKCP225ESEP	2.610,76	FKCP225EDEFD	2.018,85	FKCP225ESEFP	2.910,51
225	FKCP225EDEP	1.719,08	FKCP225ESEP	2.610,76	FKCP225EDEFD	2.018,85	FKCP225ESEFP	2.910,51
250*	FKCP280EDEP	4.480,46	FKCP280ESEP	6.391,97	FKCP280EDEFD	4.780,22	FKCP280ESEFP	6.691,74
280*	FKCP280EDEP	4.480,46	FKCP280ESEP	6.391,97	FKCP280EDEFD	4.780,22	FKCP280ESEFP	6.691,74
315*	FKCP315EDEP	4.775,80	FKCP315ESEP	6.687,31	FKCP315EDEFD	5.075,55	FKCP315ESEFP	6.987,03
50	FKCP050FDEP	939,86	FKCP050FSEP	1.126,20	FKCP050FDEFD	1.239,63	FKCP050FSEFP	1.425,97
63	FKCP063FDEP	973,69	FKCP063FSEP	1.160,06	FKCP063FDEFD	1.273,45	FKCP063FSEFP	1.459,80
75	FKCP075FDEP	1.041,62	FKCP075FSEP	1.227,97	FKCP075FDEFD	1.341,36	FKCP075FSEFP	1.527,75
90	FKCP090FDEP	1.201,28	FKCP090FSEP	1.277,25	FKCP090FDEFD	1.501,04	FKCP090FSEFP	1.577,01
110	FKCP110FDEP	1.252,71	FKCP110FSEP	1.551,69	FKCP110FDEFD	1.552,47	FKCP110FSEFP	1.851,48
125	FKCP140FDEP	1.506,60	FKCP140FSEP	2.148,39	FKCP140FDEFD	1.806,37	FKCP140FSEFP	2.448,15
140	FKCP140FDEP	1.506,60	FKCP140FSEP	2.148,39	FKCP140FDEFD	1.806,37	FKCP140FSEFP	2.448,15
160*	FKCP160FDEP	1.789,32	FKCP160FSEP	2.221,42	FKCP160FDEFD	2.089,10	FKCP160FSEFP	2.521,15
200	FKCP225FDEP	2.140,28	FKCP225FSEP	3.031,96	FKCP225FDEFD	2.440,03	FKCP225FSEFP	3.331,73
225	FKCP225FDEP	2.140,28	FKCP225FSEP	3.031,96	FKCP225FDEFD	2.440,03	FKCP225FSEFP	3.331,73
250*	FKCP280FDEP	6.414,46	FKCP280FSEP	8.326,00	FKCP280FDEFD	6.714,22	FKCP280FSEFP	8.625,75
280*	FKCP280FDEP	6.414,46	FKCP280FSEP	8.326,00	FKCP280FDEFD	6.714,22	FKCP280FSEFP	8.625,75
315*	FKCP315FDEP	6.885,63	FKCP315FSEP	8.797,14	FKCP315FDEFD	7.185,39	FKCP315FSEFP	9.096,92

Válvula de mariposa industrial motorizada
cuerpo en PPGR y disco en C-PVC
Actuación neumática.

Las válvulas neumáticas se configuran NC (normalmente cerrada) de serie.
La configuración NA (normalmente abierta) se debe especificar en el pedido

* Actuadores de aluminio



INDUSTRIA

Sistema C-PVC

Válvulas de membrana actuadas

**DK/CP NC**

d	Modelo.	DN	Ref. EPDM	€ EPDM
20	DKDC/CP NC	15	DKDCNC020E	308,00
25	DKDC/CP NC	20	DKDCNC025E	322,31
32	DKDC/CP NC	25	DKDCNC032E	394,89
40	DKDC/CP NC	32	DKDCNC040E	518,29
50	DKDC/CP NC	40	DKDCNC050E	587,42
63	DKDC/CP NC	50	DKDCNC063E	810,69
75	DKDC/CP NC	65	DKDCNC075E	972,80
90	VMDC/CP NC	80	VMDCNC090E	1.470,69
110	VMDC/CP NC	100	VMDCNC110E	1.785,23

**VM/CP NC**

Ref. FKM	€ FKM	Ref. PTFE	L € PTFE
DKDCNC020F	388,15	DKDCNC020P	399,73
DKDCNC025F	403,34	DKDCNC025P	415,37
DKDCNC032F	492,53	DKDCNC032P	520,04
DKDCNC040F	660,77	DKDCNC040P	690,30
DKDCNC050F	745,14	DKDCNC050P	745,14
DKDCNC063F	1.064,37	DKDCNC063P	1.041,83
DKDCNC075F	1.277,24	DKDCNC075P	1.250,24
VMDCNC090F	1.958,70	VMDCNC090P	1.700,68
VMDCNC110F	2.264,78	VMDCNC110P	2.011,10

Válvula neumática **NORMALMENTE CERRADA.**

M-M encolar

**DK/CP NO**

d	Modelo.	DN	Ref. EPDM	€ EPDM
20	DKDC/CP NO	15	DKDCNO020E	277,60
25	DKDC/CP NO	20	DKDCNO025E	292,88
32	DKDC/CP NO	25	DKDCNO032E	346,42
40	DKDC/CP NO	32	DKDCNO040E	373,29
50	DKDC/CP NO	40	DKDCNO050E	435,12
63	DKDC/CP NO	50	DKDCNO063E	554,04
75	DKDC/CP NO	65	DKDCNO075E	664,84
90	VMDC/CP NO	80	VMDCNO090E	1.037,67
110	VMDC/CP NO	100	VMDCNO110E	1.576,06

**VM/CP NO**

Ref. FKM	€ FKM	Ref. PTFE	L € PTFE
DKDCNO020F	363,16	DKDCNO020P	389,19
DKDCNO025F	379,40	DKDCNO025P	406,39
DKDCNO032F	397,84	DKDCNO032P	434,97
DKDCNO040F	548,34	DKDCNO040P	589,47
DKDCNO050F	624,44	DKDCNO050P	624,44
DKDCNO063F	859,21	DKDCNO063P	859,21
DKDCNO075F	1.031,06	DKDCNO075P	1.031,06
VMDCNO090F	1.641,32	VMDCNO090P	1.484,83
VMDCNO110F	1.897,80	VMDCNO110P	1.656,70

Válvula neumática **NORMALMENTE ABIERTA.**

M-M encolar

**DK/CP DE**

d	Modelo.	DN	Ref. EPDM	€ EPDM
20	DKDC/CP DE	15	DKDCDA020E	211,81
25	DKDC/CP DE	20	DKDCDA025E	226,10
32	DKDC/CP DE	25	DKDCDA032E	305,42
40	DKDC/CP DE	32	DKDCDA040E	339,39
50	DKDC/CP DE	40	DKDCDA050E	395,57
63	DKDC/CP DE	50	DKDCDA063E	503,67
75	DKDC/CP DE	65	DKDCDA075E	604,40
90	VMDC/CP DE	80	VMDCDA090E	1.259,08
110	VMDC/CP DE	100	VMDCDA110E	1.676,91

**VM/CP DE**

Ref. FKM	€ FKM	Ref. PTFE	L € PTFE
DKDCDA020F	291,96	DKDCDA020P	308,28
DKDCDA025F	307,14	DKDCDA025P	323,83
DKDCDA032F	361,69	DKDCDA032P	395,45
DKDCDA040F	498,47	DKDCDA040P	535,86
DKDCDA050F	567,67	DKDCDA050P	567,67
DKDCDA063F	781,11	DKDCDA063P	781,11
DKDCDA075F	937,33	DKDCDA075P	937,33
VMDCDA090F	1.862,74	VMDCDA090P	1.706,24
VMDCDA110F	2.153,82	VMDCDA110P	1.903,76

Válvula neumática **DOBLE EFECTO.**

M-M encolar



DK/CP NC

d	Modelo.	DN	Ref. EPDM	€ EPDM	Ref. FKM	€ FKM	Ref. PTFE	L € PTFE
20	DKUIC/CP NC	15	DKUICNC020E	319,44	DKUICNC020F	399,56	DKUICNC020P	416,24
25	DKUIC/CP NC	20	DKUICNC025E	334,72	DKUICNC025F	415,78	DKUICNC025P	442,48
32	DKUIC/CP NC	25	DKUICNC032E	411,73	DKUICNC032F	508,20	DKUICNC032P	541,62
40	DKUIC/CP NC	32	DKUICNC040E	544,10	DKUICNC040F	686,58	DKUICNC040P	720,79
50	DKUIC/CP NC	40	DKUICNC050E	616,51	DKUICNC050F	774,29	DKUICNC050P	774,29
63	DKUIC/CP NC	50	DKUICNC063E	856,86	DKUICNC063F	1.110,47	DKUICNC063P	1.110,47

Válvula neumática **NORMALMENTE CERRADA.**

Con enlaces H-H encolar



DK/CP NO

d	Modelo.	DN	Ref. EPDM	€ EPDM	Ref. FKM	€ FKM	Ref. PTFE	L € PTFE
20	DKUIC/CP NO	15	DKUICNO020E	289,82	DKUICNO020F	375,38	DKUICNO020P	407,51
25	DKUIC/CP NO	20	DKUICNO025E	306,12	DKUICNO025F	392,67	DKUICNO025P	436,69
32	DKUIC/CP NO	25	DKUICNO032E	369,23	DKUICNO032F	418,10	DKUICNO032P	463,98
40	DKUIC/CP NO	32	DKUICNO040E	406,51	DKUICNO040F	581,60	DKUICNO040P	628,24
50	DKUIC/CP NO	40	DKUICNO050E	474,24	DKUICNO050F	662,04	DKUICNO050P	662,04
63	DKUIC/CP NO	50	DKUICNO063E	611,95	DKUICNO063F	918,65	DKUICNO063P	918,65

Válvula neumática **NORMALMENTE ABIERTA.**

Con enlaces H-H encolar



DK/CP DE

d	Modelo.	DN	Ref. EPDM	€ EPDM	Ref. FKM	€ FKM	Ref. PTFE	L € PTFE
20	DKUIC/CP DE	15	DKUICDA020E	223,24	DKUICDA020F	303,37	DKUICDA020P	325,00
25	DKUIC/CP DE	20	DKUICDA025E	238,51	DKUICDA025F	319,57	DKUICDA025P	351,96
32	DKUIC/CP DE	25	DKUICDA032E	326,72	DKUICDA032F	446,82	DKUICDA032P	421,81
40	DKUIC/CP DE	32	DKUICDA040E	369,57	DKUICDA040F	528,73	DKUICDA040P	571,18
50	DKUIC/CP DE	40	DKUICDA050E	431,13	DKUICDA050F	601,86	DKUICDA050P	601,86
63	DKUIC/CP DE	50	DKUICDA063E	556,32	DKUICDA063F	835,16	DKUICDA063P	835,16

Válvula neumática **DOBLE EFECTO.**

Con enlaces H-H encolar



DK/CP NC

Rh	Modelo.	DN	Ref. EPDM	€ EPDM	Ref. FKM	€ FKM	Ref. PTFE	L € PTFE
1/2"	DKUFC/CP NC	15	DKUFCNC012E	351,40	DKUFCNC012F	395,56	DKUFCNC012P	439,52
3/4"	DKUFC/CP NC	20	DKUFCNC034E	368,18	DKUFCNC034F	411,61	DKUFCNC034P	457,32
1"	DKUFC/CP NC	25	DKUFCNC100E	452,89	DKUFCNC100F	559,03	DKUFCNC100P	595,79
1 1/4"	DKUFC/CP NC	32	DKUFCNC114E	598,49	DKUFCNC114F	755,24	DKUFCNC114P	792,87
1 1/2"	DKUFC/CP NC	40	DKUFCNC112E	678,16	DKUFCNC112F	851,72	DKUFCNC112P	851,72
2"	DKUFC/CP NC	50	DKUFCNC200E	942,52	DKUFCNC200F	1.375,60	DKUFCNC200P	1.221,52

Válvula neumática **NORMALMENTE CERRADA.**

Con enlaces H-H roscar.



DK/CP NO

Rh	Modelo.	DN	Ref. EPDM	€ EPDM	Ref. FKM	€ FKM	Ref. PTFE	L € PTFE
1/2"	DKUFC/CP NO	15	DKUFCNO012E	323,93	DKUFCNO012F	371,12	DKUFCNO012P	418,03
3/4"	DKUFC/CP NO	20	DKUFCNO034E	341,83	DKUFCNO034F	388,23	DKUFCNO034P	437,07
1"	DKUFC/CP NO	25	DKUFCNO100E	406,28	DKUFCNO100F	459,91	DKUFCNO100P	510,39
1 1/4"	DKUFC/CP NO	32	DKUFCNO114E	447,16	DKUFCNO114F	639,77	DKUFCNO114P	691,10
1 1/2"	DKUFC/CP NO	40	DKUFCNO112E	521,67	DKUFCNO112F	728,25	DKUFCNO112P	728,25
2"	DKUFC/CP NO	50	DKUFCNO200E	673,15	DKUFCNO200F	1.010,53	DKUFCNO200P	1.010,53

Válvula neumática **NORMALMENTE ABIERTA.**

Con enlaces H-H roscar.



DK/CP DE

Rh	Modelo.	DN	Ref. EPDM	€ EPDM	Ref. FKM	€ FKM	Ref. PTFE	L € PTFE
1/2"	DKUFC/CP DE	15	DKUFCDA012E	255,22	DKUFCDA012F	299,36	DKUFCDA012P	343,32
3/4"	DKUFC/CP DE	20	DKUFCDA034E	271,99	DKUFCDA034F	315,41	DKUFCDA034P	361,15
1"	DKUFC/CP DE	25	DKUFCDA100E	361,92	DKUFCDA100F	418,10	DKUFCDA100P	494,07
1 1/4"	DKUFC/CP DE	32	DKUFCDA114E	406,51	DKUFCDA114F	581,60	DKUFCDA114P	628,27
1 1/2"	DKUFC/CP DE	40	DKUFCDA112E	474,25	DKUFCDA112F	662,02	DKUFCDA112P	662,02
2"	DKUFC/CP DE	50	DKUFCDA200E	611,94	DKUFCDA200F	918,66	DKUFCDA200P	918,66

Válvula neumática **DOBLE EFECTO.**

Con enlaces H-H roscar.



DK/CP NC

d	Modelo.	DN	Ref. EPDM	€ EPDM
20	DKOC/CP NC	15	DKOCNC020E	369,59
25	DKOC/CP NC	20	DKOCNC025E	386,77
32	DKOC/CP NC	25	DKOCNC032E	473,86
40	DKOC/CP NC	32	DKOCNC040E	621,92
50	DKOC/CP NC	40	DKOCNC050E	704,91
63	DKOC/CP NC	50	DKOCNC063E	972,86
75	DKOC/CP NC	65	DKOCNC075E	1.167,43
90	VMOC/CP NC	80	VMOCNC090E	1.691,31
110	VMOC/CP NC	100	VMOCNC110E	2.053,06



VM/CP NC

Ref. FKM	€ FKM	Ref. PTFE	L € PTFE
DKOCNC020F	449,70	DKOCNC020P	460,12
DKOCNC025F	467,81	DKOCNC025P	478,72
DKOCNC032F	571,49	DKOCNC032P	599,74
DKOCNC040F	764,41	DKOCNC040P	794,81
DKOCNC050F	862,64	DKOCNC050P	862,64
DKOCNC063F	1.226,53	DKOCNC063P	1.203,94
DKOCNC075F	1.471,83	DKOCNC075P	1.444,72
VMOCNC090F	2.179,32	VMOCNC090P	1.921,31
VMOCNC110F	2.532,04	VMOCNC110P	2.278,78

Válvula neumática **NORMALMENTE CERRADA.**

Con bridas DIN.

Disponibles con bridas ANSI 150 libras al mismo precio



DK/CP NO

d	Modelo.	DN	Ref. EPDM	€ EPDM
20	DKOC/CP NO	15	DKOCNO020E	343,37
25	DKOC/CP NO	20	DKOCNO025E	361,73
32	DKOC/CP NO	25	DKOCNO032E	372,58
40	DKOC/CP NO	32	DKOCNO040E	435,67
50	DKOC/CP NO	40	DKOCNO050E	564,34
63	DKOC/CP NO	50	DKOCNO063E	732,38
75	DKOC/CP NO	65	DKOCNO075E	878,84
90	VMOC/CP NO	80	VMOCNO090E	1.258,28
110	VMOC/CP NO	100	VMOCNO110E	1.782,95



VM/CP NO

Ref. FKM	€ FKM	Ref. PTFE	L € PTFE
DKOCNO020F	428,91	DKOCNO020P	455,63
DKOCNO025F	448,26	DKOCNO025P	476,03
DKOCNO032F	484,73	DKOCNO032P	522,64
DKOCNO040F	662,30	DKOCNO040P	704,49
DKOCNO050F	753,69	DKOCNO050P	753,69
DKOCNO063F	1.037,57	DKOCNO063P	1.037,57
DKOCNO075F	1.245,08	DKOCNO075P	1.245,08
VMOCNO090F	1.861,92	VMOCNO090P	1.705,43
VMOCNO110F	2.163,30	VMOCNO110P	1.856,65

Válvula neumática **NORMALMENTE ABIERTA.**

Con bridas DIN.

Disponibles con bridas ANSI 150 libras al mismo precio



DK/CP DE

d	Modelo.	DN	Ref. EPDM	€ EPDM
20	DKOC/CP DE	15	DKOCDA020E	273,40
25	DKOC/CP DE	20	DKOCDA025E	290,58
32	DKOC/CP DE	25	DKOCDA032E	389,46
40	DKOC/CP DE	32	DKOCDA040E	442,98
50	DKOC/CP DE	40	DKOCDA050E	513,05
63	DKOC/CP DE	50	DKOCDA063E	665,78
75	DKOC/CP DE	65	DKOCDA075E	798,94
90	VMOC/CP DE	80	VMOCDA090E	1.479,68
110	VMOC/CP DE	100	VMOCDA110E	1.870,86



VM/CP DE

Ref. FKM	€ FKM	Ref. PTFE	L € PTFE
DKOCDA020F	353,50	DKOCDA020P	368,64
DKOCDA025F	371,61	DKOCDA025P	387,10
DKOCDA032F	440,68	DKOCDA032P	475,12
DKOCDA040F	602,09	DKOCDA040P	640,44
DKOCDA050F	685,19	DKOCDA050P	685,19
DKOCDA063F	943,25	DKOCDA063P	943,25
DKOCDA075F	1.131,90	DKOCDA075P	1.131,90
VMOCDA090F	2.083,37	VMOCDA090P	1.926,85
VMOCDA110F	2.420,57	VMOCDA110P	2.097,71

Válvula neumática **DOBLE EFECTO.**

Con bridas DIN.

Disponibles con bridas ANSI 150 libras al mismo precio

CMDC/CP NC*M-M encolar***CMUIC/CP NC***H-H enlaces encolar*

d	Ref. EPDM	DN	L		
			€ EPDM	€ FKM	€ PTFE
20	CMDCNC020E	15	194,08	210,88	227,74
20	CMUICNC020E	15	232,24	253,54	272,61 (A)

Válvula de membrana.
compacta neumática
NORMALMENTE CERRADA.

Código en FKM termina en "F"
en lugar de "E"
Código en PTFE termina en "F"
en lugar de "E"
(A) Juntas en FKM

CMDC/CP NO*M-M encolar***CMUIC/CP NO***H-H enlaces encolar*

d	Ref. EPDM	DN	L		
			€ EPDM	€ FKM	€ PTFE
20	CMDCNO020E	15	190,69	208,64	223,24
20	CMUICNO020E	15	228,85	251,28	270,39 (A)

Válvula de membrana.
compacta neumática
NORMALMENTE ABIERTA.

Código en FKM termina en "F"
en lugar de "E"
Código en PTFE termina en "F"
en lugar de "E"
(A) Juntas en FKM

CMDC/CP DE*M-M encolar***CMUIC/CP DE***H-H enlaces encolar*

d	Ref. EPDM	DN	L		
			€ EPDM	€ FKM	€ PTFE
20	CMDCDA020E	15	190,69	208,64	223,24
20	CMUICDA020E	15	228,85	251,28	270,39 (A)

Válvula de membrana.
compacta neumática
DOBLE EFECTO.

Código en FKM termina en "F"
en lugar de "E"
Código en PTFE termina en "F"
en lugar de "E"
(A) Juntas en FKM

DKBDC/CP NC



L

d	Ref. EPDM	DN	PN	€ EPDM
20	DKBDCNC020E	15	6	286,67
25	DKBDCNC025E	20	6	300,97
32	DKBDCNC032E	25	6	374,40
40	DKBDCNC040E	32	6	466,99
50	DKBDCNC050E	40	6	485,54
63	DKBDCNC063E	50	6	680,16
75	DKBDCNC075E	65	6	801,77

Válvula de membrana neumática
NORMALMENTE CERRADA.

Actuador a pistón

M-M encolar

DKBUIC/CP NC



L

d	Ref. EPDM	DN	PN	€ EPDM
20	DKBUICNC020E	15	6	699,41
25	DKBUICNC025E	20	6	475,00
32	DKBUICNC032E	25	6	503,60
40	DKBUICNC040E	32	6	287,74
50	DKBUICNC050E	40	6	304,03
63	DKBUICNC063E	50	6	381,73

Válvula de membrana neumática
NORMALMENTE CERRADA.

Actuador a pistón

Con enlaces H-H encolar

DKBUFC/CP NC



L

d	Ref. EPDM	DN	PN	€ EPDM
½"	DKBUFCNC012E	15	6	287,74
¾"	DKBUFCNC034E	20	6	304,03
1"	DKBUFCNC100E	25	6	381,73
1 ¼"	DKBUFCNC114E	32	6	475,00
1 ½"	DKBUFCNC112E	40	6	503,60
2"	DKBUFCNC200E	50	6	699,41

Válvula de membrana neumática
NORMALMENTE CERRADA.

Actuador a pistón

Con enlaces H-H para roscar

DKBOC/CP NC



L

d	Ref. EPDM	DN	PN	€ EPDM
20	DKBOCNC020E	15	6	329,65
25	DKBOCNC025E	20	6	346,08
32	DKBOCNC032E	25	6	438,66
40	DKBOCNC040E	32	6	551,87
50	DKBOCNC050E	40	6	573,78
63	DKBOCNC063E	50	6	803,82
75	DKBOCNC075E	65	6	1.026,48

Válvula de membrana neumática
NORMALMENTE CERRADA.

Actuador a pistón

Con bridas DIN

DKBOAC/CP NC



L

d	Ref. EPDM	DN	PN	€ EPDM
½"	DKBOACNC012E	15	6	329,65
¾"	DKBOACNC034E	20	6	346,08
1"	DKBOACNC100E	25	6	438,66
1 ¼"	DKBOACNC114E	32	6	551,87
1 ½"	DKBOACNC112E	40	6	573,78
2"	DKBOACNC200E	50	6	803,82
2 ½"	DKBOACNC212E	65	6	1.026,48

Válvula de membrana neumática
NORMALMENTE CERRADA.

Actuador a pistón

Con bridas ANSI 150 lbs



INDUSTRIA

Sistema C-PVC

Conectores



MANGUITO

C1

d	Ref.	Para válvulas	€
16	ENDIC016	VKD-TKD-VXE-SXE-RV	20,50
20	ENDIC020	VKD-TKD-VXE-SXE-RV	20,50
25	ENDIC025	VKD-TKD-VXE-SXE-RV	34,79
32	ENDIC032	VKD-TKD-VXE-SXE-RV	36,84
40	ENDIC040	VKD-TKD-VXE-SXE-RV	40,96
50	ENDIC050	VKD-TKD-VXE-SXE-RV	45,04
63	ENDIC063	VKD-TKD-VXE-SXE-RV	51,21
75	ENDIC075	VKD-VXE-SSE	61,42
90	ENDIC090	VKD	90,12
90	ENDIC090VXE	VXE-SXE	90,12
110	ENDIC110	VKD	112,62
110	ENDIC110VXE	VXE-SXE	112,62

Conector final en C-PVC.
H encolar.



MANGUITO

C1

Rh	Ref.	Para válvulas	€
3/8"	ENDFC038	VKD-TKD-VXE-SXE-RV	20,50
1/2"	ENDFC012	VKD-TKD-VXE-SXE-RV	20,50
3/4"	ENDFC034	VKD-TKD-VXE-SXE-RV	34,79
1"	ENDFC100	VKD-TKD-VXE-SXE-RV	36,84
1 1/4"	ENDFC114	VKD-TKD-VXE-SXE-RV	40,96
1 1/2"	ENDFC112	VKD-TKD-VXE-SXE-RV	45,04
2"	ENDFC200	VKD	51,21
2 1/2"	ENDFC212	VKD	61,42
3"	ENDFC300	VKD	90,12
3"	ENDFC300VXE	VXE-SXE	90,12
4"	ENDFC400	VKD	112,62
4"	ENDFC400VXE	VXE-SXE	112,62

Conector final en C-PVC.
H rosca GAS.



MANGUITO

C1

d	Ref.	Para válvulas	€
1/2"	ENDAC012	VKD-TKD-VXE-SXE-RV	20,50
3/4"	ENDAC034	VKD-TKD-VXE-SXE-RV	34,79
1"	ENDAC100	VKD-TKD-VXE-SXE-RV	36,84
1 1/4"	ENDAC114	VKD-TKD-VXE-SXE-RV	40,96
1 1/2"	ENDAC112	VKD-TKD-VXE-SXE-RV	45,04
2"	ENDAC200	VKD-TKD-VXE-SXE-RV	51,21
2 1/2"	ENDAC212	VKD	61,42
3"	ENDAC300	VKD	90,12
3"	ENDAC300VXE	VKD	90,12
4"	ENDAC400	VXE-SXE	112,62
4	ENDAC400VXE	VKD	112,62

Conector final en C-PVC.
H encolar serie ASTM.



MANGUITO

C1

d	Ref.	Para válvulas	€
16	ENDDC016	VKD-TKD-VXE-SXE-RV	20,50
20	ENDDC020	VKD-TKD-VXE-SXE-RV	20,50
25	ENDDC025	VKD-TKD-VXE-SXE-RV	34,79
32	ENDDC032	VKD-TKD-VXE-SXE-RV	36,84
40	ENDDC040	VKD-TKD-VXE-SXE-RV	40,96
50	ENDDC050	VKD-TKD-VXE-SXE-RV	45,04
63	ENDDC063	VKD-TKD-VXE-SXE-RV	51,21
75	ENDDC075	VKD	61,42
90	ENDDC090	VKD	90,12
90	ENDDC090VXE	VXE-SSE	90,12
110	ENDDC110	VKD	112,62
110	ENDDC110VXE	VXE-SSE	112,62

Conector final en C-PVC.
M encolar.



MANGUITO

C1

Rh	Ref.	Para válvulas	€
1/2"	ENDNC012	VKD-TKD-VXE-SXE-RV	20,50
3/4"	ENDNC034	VKD-TKD-VXE-SXE-RV	34,79
1"	ENDNC100	VKD-TKD-VXE-SXE-RV	36,84
1 1/4"	ENDNC114	VKD-TKD-VXE-SXE-RV	40,96
1 1/2"	ENDNC112	VKD-TKD-VXE-SXE-RV	45,04
2"	ENDNC200	VKD-TKD-VXE-SXE-RV	51,21
2 1/2"	ENDNC212	VKD	61,42
3"	ENDNC300	VKD	90,12
3"	ENDNC300VXE	VXE-SXE	90,12
4"	ENDNC400	VKD	112,62
4	ENDNC400VXE	VXE-SXE	112,62

Conector final en C-PVC.
H rosca NPT

Accesorios mecánicos para la unión de tuberías

INDUSTRIA



Accesorios mecánicos





INDUSTRIA

Accesorios mecánicos para la unión de tuberías

Acoplamientos para tubos metálicos



J1

METAL GRIP

diámetro exterior	PN (bar)	PN (bar)	CARCASA EN ACERO GALVANIZADO				CARCASA EN ACERO INOXIDABLE			
			Ref. EPDM	€ EPDM	Ref. NBR	€ NBR	Ref. EPDM	€ EPDM	Ref. NBR	€ NBR
30,0	67,0	16,0	50	154,34	51	154,34	58	183,82	57	183,82
33,7	62,0	16,0	86	155,42	123	155,42	126	185,64	127	185,64
38,0	58,0	16,0	110	156,18	122	156,18	40100	185,64	40101	185,64
42,4	53,0	16,0	11045	157,43	11047	157,43	40150	187,46	40151	187,46
44,5	48,0	16,0	129	158,34	130	158,34	40200	187,46	40201	187,46
48,3	44,0	16,0	11048	160,73	11050	160,73	40250	189,30	40251	189,30
54,0	39,0	16,0	8669	161,62	8671	161,62	8668	191,12	8670	191,12
57,0	37,0	16,0	11052	162,90	11051	162,90	11043	192,94	11053	192,94
60,3	37,0	16,0	11054	165,98	11056	165,98	11044	194,75	11055	194,75
63,5	37,0	16,0	209	172,18	210	172,18	211	202,04	212	202,04
73,0	56,0	16,0	186	192,94	187	192,94	104105	229,35	192	229,35
76,1	56,0	16,0	215	196,57	155	196,57	40450	232,99	40451	232,99
84,0	45,0	16,0	216	209,33	156	209,33	104060	243,90	102278	243,90
88,9	41,0	16,0	135	211,12	157	211,12	40550	247,52	40551	247,52
104,0	37,0	16,0	136	234,78	158	234,78	173	267,56	197	267,56
108,0	35,0	16,0	137	238,42	159	238,42	40650	271,20	40651	271,20
114,3	34,0	16,0	138	249,38	160	249,38	40700	283,95	40701	283,95
129,0	33,0	16,0	139	336,72	161	336,72	40600	394,97	40601	394,97
133,0	33,0	16,0	140	345,83	162	345,83	40602	402,25	40603	402,25
139,7	32,0	16,0	141	384,04	163	384,04	40614	442,29	40611	442,29
154,0	32,0	16,0	142	422,27			40622	480,51		
159,0	31,0	16,0	143	427,72	165	427,72	40634	485,96	40631	485,96
168,3	29,0	16,0	144	455,02	166	455,02	40655	511,45	40652	511,45
180,0	29,0	16,0	1650	813,57	1651	813,57				
193,7	29,0	16,0	1537	833,58	1542	833,58				
200,0	28,0	15,0	1652	844,55	1653	844,55				
206,0	28,0	15,0	1641	853,63	1654	853,63				
219,1	26,0	16,0	145	908,22	167	908,22	41050	1.015,60	41051	1.015,60
244,5	27,0	14,0	1572	915,51	1573	915,51				
267,0	24,0	12,0	1574	950,07	1575	950,07				
273,0	21,0	12,0	1567	990,13	1568	990,13				
323,9	18,0	10,0	1576	1.042,91	1577	1.042,91				
355,6	17,0	8,0	1579	1.088,42	1578	1.088,42				
406,4	14,0	8,0	1607	1.181,25	1608	1.181,25				
457,2	8,0	6,0	1609	1.275,89	1610	1.275,89				
508,0	6,0	5,0	1611	1.376,00	1612	1.376,00				
558,8	6,0	4,5	1613	1.476,08	1614	1.476,08				
609,6	5,0	4,0	1615	1.576,20	1616	1.576,20				

Acoplamiento para tubos metálicos con anclaje axial.
Acoplamientos para muy alta presión de alta calidad.
Máximo rendimiento.

Junta: EPDM: -30°C hasta +100°C NBR: -20°C hasta +80°C
Fluido: EPDM: Todas las calidades de agua, aguas residuales, aire, sólidos y diversos productos químicos.
NBR: Agua, gas, aceite, combustible y otros hidrocarburos.



J1

METAL GRIP FIRE FENCE

diámetro exterior	PN (bar)	PN (bar)	CARCASA EN ACERO GALVANIZADO				CARCASA EN ACERO INOXIDABLE			
			Ref. EPDM	€ EPDM	Ref. NBR	€ NBR	Ref. EPDM	€ EPDM	Ref. NBR	€ NBR
30,0	67,0	16,0	19299	247,53	19349	247,53	105039	274,83	105026	274,83
33,7	62,0	16,0	19300	249,38	19350	249,38	105040	276,65	105027	276,65
38,0	58,0	16,0	19301	251,17	19351	251,17	105041	278,48	105028	278,48
42,4	53,0	16,0	19302	253,00	19352	253,00	105042	282,11	105029	282,11
44,5	48,0	16,0	19303	253,00	19353	253,00	40206	282,11	105030	282,11
48,3	44,0	16,0	19304	254,81	19354	254,81	105043	283,95	105031	283,95
54,0	39,0	16,0	19305	258,45	19355	258,45	19405	291,23	19455	291,23
57,0	37,0	16,0	19306	258,45	19356	258,45	19406	291,23	19456	291,23
60,3	37,0	16,0	19307	262,09	19357	262,09	19407	294,87	19457	294,87
63,5	37,0	16,0	19433	263,93	19432	263,93	19430	296,66	19431	296,66
76,1	56,0	16,0	19308	298,50	19358	298,50	105044	331,25	105032	331,25
84,0	45,0	16,0	19309	311,26	19359	311,26	19551	345,84	19552	345,84
88,9	41,0	16,0	19310	313,05	19360	313,05	105045	347,64	105033	347,64
104,0	37,0	16,0	19311	336,72	19361	336,72	19571	373,14	19572	373,14
108,0	35,0	16,0	19312	338,53	19362	338,53	105046	374,94	105034	374,94
114,3	34,0	16,0	19314	360,38	19364	360,38	105047	393,14	105035	393,14
129,0	33,0	16,0	19315	495,08	19365	495,08	19585	553,31	19568	553,31
133,0	33,0	16,0	19316	502,35	19366	502,35	19594	560,59	19593	560,59
139,7	32,0	16,0	19317	580,62	19367	580,62	105048	638,86	105036	638,86
154,0	32,0	16,0	19318	642,51			19601	700,75		
159,0	31,0	16,0	19319	649,77	19369	649,77	19603	708,03	19604	708,03
168,3	29,0	16,0	19321	695,28	19371	695,28	105049	753,51	19635	753,51
219,1	26,0	16,0	19323	1.379,63	19373	1.379,63	105050	1.490,67	105038	1.490,67
244,5	27,0	14,0	19324	1.616,24	19378	1.616,24				
267,0	24,0	12,0	19325	1.669,03	19380	1.669,03				
273,0	21,0	12,0	19326	1.709,06	19379	1.709,06				
323,9	18,0	10,0	19327	1.798,26	19381	1.798,26				
355,6	17,0	8,0	19328	1.881,99	19383	1.881,99				
406,4	14,0	8,0	19329	2.029,40	19384	2.029,40				
457,2	8,0	6,0	19330	2.185,94	19385	2.185,94				

Acoplamiento para tubos metálicos con anclaje axial y con protección al fuego.

Acoplamientos para muy alta presión de alta calidad.

Máximo rendimiento.

Junta: EPDM: -30°C hasta +100°C NBR: -20°C hasta +80°C

Fluido: EPDM: Todas las calidades de agua, aguas residuales, aire, sólidos y diversos productos químicos.

NBR: Agua, gas, aceite, combustible y otros hidrocarburos.



J1

GRIP

diámetro exterior	PN (bar)	PN (bar)	CARCASA EN ACERO INOXIDABLE					
			Ref. EPDM	€ EPDM	Ref. NBR	€ NBR	Ref. FKM	€ FKM
25,0	64,0	16,0	G20041	67,36	G20040	67,36	G20043	147,05
26,9	58,0	16,0	G20000	68,43	G20001	68,43	G20011	148,14
28,0	50,0	16,0	G20025	69,16	G20026	69,16	G20027	148,89
30,0	42,0	16,0	G20050	70,27	G20051	70,27	G20054	149,99
33,7	39,0	16,0	G20100	72,42	G20101	72,42	G20110	149,99
35,0	37,0	16,0	G20124	75,89	G20125	75,89	G20126	149,99
38,0	36,0	16,0	G20150	83,72	G20151	83,72	G20164	149,99
40,0	35,0	16,0	G20175	84,81	G20176	84,81	G20177	150,91
42,4	33,0	16,0	G20200	86,10	G20201	86,10	G20206	151,79
44,5	30,0	16,0	G20250	88,10	G20251	88,10	G20253	151,79
48,3	28,0	16,0	G20300	90,29	G20301	90,29	G20306	153,80
54,0	24,0	16,0	G20350	101,19	G20351	101,19	G20360	153,80
57,0	23,0	16,0	G20400	103,74	G20401	103,74	G20406	157,43
60,3	23,0	16,0	G20450	105,76	G20451	105,76	G20456	161,27
63,0	23,0	16,0	G20425	115,95	G20426	115,95	G20427	178,00
66,6	22,0	16,0	G20470	129,58	G20471	129,58	G20476	200,20
70,0	22,0	16,0	G20485	131,58	G20486	131,58	G20494	202,04
73,0	21,0	16,0	G20500	134,87	G20501	134,87	G20506	202,04
76,1	35,0	16,0	G20550	137,78	G20551	137,78	G20558	205,66
79,5	32,0	16,0	G20570	140,32	G20583	140,32	G20584	208,03
84,0	29,0	16,0	G20600	144,33	G20601	144,33	G20606	209,33
88,9	26,0	16,0	G20650	148,52	G20651	148,52	G20656	214,77
95,0	24,0	16,0	G20667	151,44	G20677	151,44	G20678	218,42
98,0	24,0	16,0	G20690	152,86	G20691	152,86	G20692	218,42
100,6	23,0	16,0	G20700	154,15	G20701	154,15	G20706	220,22
101,6	23,0	16,0	G20750	154,72	G20751	154,72		
104,0	23,0	16,0	G20800	154,72	G20801	154,72		
104,8	23,0	16,0	G20825	156,36	G20826	156,36		
108,0	22,0	16,0	G20850	159,63	G20851	159,63	G20865	222,08
114,3	22,0	16,0	G20900	164,36	G20901	164,36	G20906	225,71
118,0	22,0	16,0	G20930	167,08	G20931	167,08	G20932	227,50
125,0	21,0	16,0	G20940	232,98	G20941	232,98	G20942	243,90

Acoplamiento para tubos metálicos
con anclaje axial.

Acoplamiento para alta presión de alta calidad.

Continúa en la página siguiente...

J1

diámetro exterior	PN (bar)	PN (bar)	CARCASA EN ACERO INOXIDABLE					
			Ref. EPDM	€ EPDM	Ref. NBR	€ NBR	Ref. FKM	€ FKM
127,0	21,0	16,0	G20950	234,78	G20951	234,78	G20957	251,17
129,0	21,0	16,0	G21000	236,61	G21001	236,61	G21006	262,09
130,2	21,0	16,0	G21050	236,61	G21051	236,61	G21052	267,56
133,0	21,0	16,0	G21100	238,42	G21101	238,42	G21112	283,95
139,7	20,0	16,0	G21150	243,90	G21151	243,90	G21165	318,53
141,3	20,0	16,0	G21200	245,71	G21201	245,71	G21208	325,80
144,0	20,0	16,0	G21225	247,53	G21226	247,53	G21227	340,37
154,0	18,0	16,0	G21250	253,00	G21251	253,00	G21262	393,14
159,0	18,0	16,0	G21300	256,64	G21301	256,64	G21309	420,44
165,0	16,0	16,0	G21328	262,09	G21326	262,09	G21331	451,36
168,3	16,0	16,0	G21350	263,93	G21351	263,93	G21369	469,59
219,1	16,0	10,0	21400	462,29	21401	462,29	21408	609,72
180,0	16,0	10,0	24950	647,93	24952	647,93	24955	687,99
193,7	16,0	10,0	25000	664,32	25002	664,32	25007	702,54
200,0	15,0	10,0	25010	671,60	25012	671,60	25015	709,81
204,0	14,0	10,0	25050	673,45	25052	673,45	25049	715,31
206,0	14,0	5,5	25058	673,45	25068	673,45	25072	715,31
244,5	9,0	5,5	25100	687,99	25102	687,99	25106	735,33
250,0	9,0	5,5	25110	691,64	25112	691,64	25115	746,24
254,0	9,0	5,5	25125	695,28	25127	695,28	25131	753,51
256,0	9,0	5,5	25140	695,28	25143	695,28	25145	753,51
267,0	8,0	5,0	25150	702,54	25152	702,54	25157	777,19
273,0	7,0	4,0	25200	704,38	25202	704,38	25207	788,10
306,0	6,0	3,0	25260	724,41	25263	724,41	25265	844,55
323,9	5,0	3,0	25300	740,76	25302	740,76	25309	880,92
355,6	10,0	2,5	25353	777,19	25352	777,19	25351	1.230,39
406,4	7,0	2,0	25413	831,79	25403	831,79	25402	1.315,93
457,2	5,0		25434	890,03	25435	890,03	25436	1.410,58
508,0	4,0		25453	944,63	25452	944,63	25462	1.494,33
558,8	3,0		25483	1.001,06	25484	1.001,06	25485	1.585,30
609,6	2,0		25517	1.055,66	25518	1.055,66	25519	1.676,33
711,2	1,0		26001	1.170,31	26002	1.170,31	26003	1.858,33

Junta: EPDM: -20°C hasta +100°C NBR: -20°C hasta +80°C FKM: -20°C hasta +180°C

Fluido: EPDM: Todas las calidades de agua, aguas residuales, aire, sólidos y diversos productos químicos.

NBR: Agua, gas, aceite, combustible y otros hidrocarburos.

FKM: Ozono, oxígeno, ácidos, gas, aceite y carburantes.



J1

GRIP

diámetro exterior	PN (bar)	PN (bar)	CARCASA EN ACERO GALVANIZADO					
			Ref. EPDM	€ EPDM	Ref. NBR	€ NBR	Ref. FKM	€ FKM
180,0	16,0	10,0	24951	591,55	24953	591,55	24954	631,59
193,7	16,0	10,0	25001	607,91	25003	607,91	25006	646,14
200,0	15,0	10,0	25011	615,18	25013	615,18	25014	653,44
204,0	14,0	10,0	25051	616,99	25053	616,99	25048	660,69
206,0	14,0	5,5	25066	616,99	25067	616,99	25069	660,69
244,5	9,0	5,5	25101	631,59	25103	631,59	25105	678,89
250,0	9,0	5,5	25111	637,02	25113	637,02	25114	689,81
254,0	9,0	5,5	25126	638,86	25128	638,86	25132	697,11
256,0	9,0	5,5	25141	638,86	25142	638,86	25144	697,11
267,0	8,0	5,0	25151	646,14	25153	646,14	25156	722,57
273,0	7,0	4,0	25201	647,93	25203	647,93	25198	731,67
306,0	6,0	3,0	25261	667,97	25262	667,97	25264	788,10
323,9	5,0	3,0	25301	684,35	25303	684,35	25315	824,50
355,6	10,0	2,5	101099	722,57	101100	722,57	101101	1.153,95
406,4	7,0	2,0	101102	775,37	101103	775,37	101104	1.241,31
457,2	5,0		101105	833,58	101106	833,58	101107	1.334,15
508,0	4,0		101108	886,39	101109	886,39	101110	1.419,67
558,8	3,0		101111	944,63	101112	944,63	101113	1.510,66
609,6	2,0		101114	1.001,06	101115	1.001,06	101116	1.601,69
711,2	1,0		26000	1.115,73	101117	1.115,73	101118	1.783,71

Acoplamiento para tubos metálicos con anclaje axial.

Acoplamientos para alta presión de alta calidad.

Junta: EPDM: -20°C hasta +100°C

NBR: -20°C hasta +80°C

FKM: -20°C hasta +180°C

Fluido: EPDM: Todas las calidades de agua, aguas residuales, aire, sólidos y diversos productos químicos.

NBR: Agua, gas, aceite, combustible y otros hidrocarburos.



FKM: Ozono, oxígeno, ácidos, gas, aceite y carburantes.



J1

GRIP FIRE FENCE

CARCASA EN ACERO INOXIDABLE

diámetro exterior	 PN (bar)	 PN (bar)	Ref. EPDM	€ EPDM	Ref. NBR	€ NBR	Ref. FKM	€ FKM
25,0	64,0	16,0	G20044	157,49	G20042	157,49	G20045	212,72
26,9	58,0	16,0	G20007	158,60	G20008	158,60	G20013	212,72
28,0	50,0	16,0	G20028	158,60	G20029	158,60	G20030	214,31
30,0	42,0	16,0	G20056	158,60	G20057	158,60	G20058	214,31
33,7	39,0	16,0	G20108	158,60	G20109	158,60	G20114	214,31
35,0	37,0	16,0	G20127	160,32	G20128	160,32	G20129	215,90
38,0	36,0	16,0	G20157	160,32	G20158	160,32	G20165	217,50
40,0	35,0	16,0	G20178	160,32	G20179	160,32	G20180	219,08
42,4	33,0	16,0	G20209	160,32	G20210	160,32	G20214	220,68
44,5	30,0	16,0	G20258	160,32	G20259	160,32	G20263	220,68
48,3	28,0	16,0	G20310	161,91	G20311	161,91	G20318	222,24
54,0	24,0	16,0	G20358	165,11	G20359	165,11	G20362	223,84
57,0	23,0	16,0	G20408	165,11	G20409	165,11	G20412	227,02
60,3	23,0	16,0	G20464	168,27	G20465	168,27	G20448	227,02
63,0	23,0	16,0	G20428	173,04	G20429	173,04	G20430	233,35
66,6	22,0	16,0	G20474	179,39	G20475	179,39	G20477	241,30
70,0	22,0	16,0	G20492	185,73	G20493	185,73	G20495	252,41
73,0	21,0	16,0	G20508	192,08	G20509	192,08	G20510	255,58
76,1	35,0	16,0	G20567	198,43	G20568	198,43	G20581	258,76
79,5	32,0	16,0	G20574	203,21	G20575	203,21	G20582	263,52
84,0	29,0	16,0	G20607	207,96	G20608	207,96	G20613	268,28
88,9	26,0	16,0	G20664	209,55	G20665	209,55	G20676	268,28
95,0	24,0	16,0	G20679	215,90	G20680	215,90	G20681	273,05
98,0	24,0	16,0	G20693	219,08	G20694	219,08	G20695	276,23
100,6	23,0	16,0	G20704	220,68	G20705	220,68	G20707	277,82
101,6	23,0	16,0	G20757	222,24	G20758	222,24	G20759	279,39
104,0	23,0	16,0	G20806	227,02	G20807	227,02	G20812	284,16
104,8	23,0	16,0	G20829	227,02	G20830	227,02	G20831	284,16
108,0	22,0	16,0	G20863	228,60	G20864	228,60	G20866	285,75
114,3	22,0	16,0	G20913	238,13	G20914	238,13	G20925	290,51

Acoplamiento para tubos metálicos con anclaje axial y con protección al fuego. Acoplamientos para alta presión de alta calidad.

Junta: EPDM: -20°C hasta +100°C NBR: -20°C hasta +80°C FKM: -20°C hasta +180°C
 Fluido: EPDM: Todas las calidades de agua, aguas residuales, aire, sólidos y diversos productos químicos.
 NBR: Agua, gas, aceite, combustible y otros hidrocarburos.
 FKM: Ozono, oxígeno, ácidos, gas, aceite y carburantes.

Continúa en la página siguiente...



J1

GRIP FIRE FENCE

diámetro exterior	PN (bar)	PN (bar)	CARCASA EN ACERO INOXIDABLE					
			Ref. EPDM	€ EPDM	Ref. NBR	€ NBR	Ref. FKM	€ FKM
118,0	22,0	16,0	G20933	244,50	G20934	244,50	G20935	293,69
125,0	21,0	16,0	G20943	296,87	G20944	296,87	G20945	306,40
127,0	21,0	16,0	G20954	309,55	G20955	309,55	G20958	325,45
129,0	21,0	16,0	G21004	322,25	G21005	322,25	G21007	344,51
130,2	21,0	16,0	G21054	328,62	G21055	328,62	G21056	358,79
133,0	21,0	16,0	G21106	344,51	G21107	344,51	G21113	385,78
139,7	20,0	16,0	G21156	384,17	G21157	384,17	G21169	449,26
141,3	20,0	16,0	G21206	393,69	G21207	393,69	G21209	466,75
144,0	20,0	16,0	G21228	398,48	G21229	398,48	G21230	481,01
154,0	18,0	16,0	G21256	414,32	G21257	414,32	G21264	536,58
159,0	18,0	16,0	G21306	419,12	G21307	419,12	G21312	560,39
165,0	16,0	16,0	G21329	433,39	G21330	433,39	G21332	598,50
168,3	16,0	16,0	G21358	441,33	G21359	441,33	G21377	619,11
219,1	16,0	10,0	21409	815,97	21410	815,97	21418	942,96
180,0	16,0	10,0	24957	1.133,49	24958	1.133,49	24960	1.166,81
193,7	16,0	10,0	24997	1.149,35	25008	1.149,35	24999	1.184,28
200,0	15,0	10,0	25018	1.157,30	25019	1.157,30	25021	1.192,21
204,0	14,0	10,0	25044	1.163,65	25045	1.163,65	25047	1.201,75
206,0	14,0	5,5	25076	1.163,65	25077	1.163,65	25079	1.201,75
244,5	9,0	5,5	25096	1.211,26	25097	1.211,26	25099	1.252,56
250,0	9,0	5,5	25116	1.219,22	25117	1.219,22	25119	1.266,81
254,0	9,0	5,5	25133	1.223,97	25134	1.223,97	25136	1.274,77
256,0	9,0	5,5	25146	1.223,97	25147	1.223,97	25149	1.274,77
267,0	8,0	5,0	25159	1.239,83	25158	1.239,83	25163	1.304,93
273,0	7,0	4,0	25212	1.243,02	25211	1.243,02	25196	1.314,44
306,0	6,0	3,0	25268	1.268,42	25269	1.268,42	25271	1.373,21
323,9	5,0	3,0	25312	1.304,93	25314	1.304,93	25297	1.427,16
355,6	10,0	2,5	25359	1.370,02	25511	1.370,02	25349	1.763,73
406,4	7,0	2,0	25415	1.466,86	25412	1.466,86	25397	1.889,13

Acoplamiento para tubos metálicos con anclaje axial.

Acoplamiento para alta presión de alta calidad.

Junta: EPDM: -20°C hasta +100°C NBR: -20°C hasta +80°C FKM: -20°C hasta +180°C

Fluido: EPDM: Todas las calidades de agua, aguas residuales, aire, sólidos y diversos productos químicos.

NBR: Agua, gas, aceite, combustible y otros hidrocarburos.

FKM: Ozono, oxígeno, ácidos, gas, aceite y carburantes.



J1

GRIP FIRE FENCE

diámetro exterior	PN (bar)	PN (bar)	CARCASA EN ACERO GALVANIZADO					
			Ref. EPDM	€ EPDM	Ref. NBR	€ NBR	Ref. FKM	€ FKM
180,0	16,0	10,0	24956	1.084,28	24961	1.084,28	24959	1.119,18
193,7	16,0	10,0	24995	1.100,13	24996	1.100,13	24998	1.135,09
200,0	15,0	10,0	25016	1.108,10	25017	1.108,10	25020	1.142,99
204,0	14,0	10,0	25042	1.114,45	25043	1.114,45	25046	1.152,52
206,0	14,0	5,5	25073	1.114,45	25074	1.114,45	25078	1.152,52
244,5	9,0	5,5	25094	1.162,06	25095	1.162,06	25098	1.203,33
250,0	9,0	5,5	25108	1.169,99	25109	1.169,99	25118	1.217,62
254,0	9,0	5,5	25123	1.176,35	25124	1.176,35	25135	1.227,15
256,0	9,0	5,5	25138	1.176,35	25139	1.176,35	25148	1.227,15
267,0	8,0	5,0	25160	1.190,63	25161	1.190,63	25162	1.255,74
273,0	7,0	4,0	25193	1.193,82	25194	1.193,82	25195	1.265,25
306,0	6,0	3,0	25266	1.219,22	25267	1.219,22	25270	1.324,00
323,9	5,0	3,0	25294	1.255,74	25295	1.255,74	25296	1.377,96
355,6	10,0	2,5	25346	1.320,78	25347	1.320,78	25348	1.698,62
406,4	7,0	2,0	25394	1.417,66	25395	1.417,66	25396	1.822,45

Acoplamiento para tubos metálicos con anclaje axial y **con protección al fuego**.
 Acoplamientos para alta presión de alta calidad.

Junta: EPDM: -20°C hasta +100°C NBR: -20°C hasta +80°C FKM: -20°C hasta +180°C
Fluido: EPDM: Todas las calidades de agua, aguas residuales, aire, sólidos y diversos productos químicos.
 NBR: Agua, gas, aceite, combustible y otros hidrocarburos.
 FKM: Ozono, oxígeno, ácidos, gas, aceite y carburantes.



INDUSTRIA

Accesorios mecánicos para la unión de tuberías

Acoplamiento para transiciones de tubos plásticos a metálicos



J1

COMBI-GRIP

diámetro exterior	PN (bar)	CARCASA EN ACERO GALVANIZADO				CARCASA EN ACERO INOXIDABLE			
		Ref. EPDM	€ EPDM	Ref. NBR	€ NBR	Ref. EPDM	€ EPDM	Ref. NBR	€ NBR
40,0 / 38,0	16,0	9130	173,27	9132	173,27	14800	200,21	14801	200,21
40,0 / 42,4	16,0	9120	173,27	9123	173,27	104274	200,21	14802	200,21
50,0 / 48,3	16,0	6768	177,83	6769	177,83	100602	205,67	104782	205,67
63,0 / 60,3	16,0	9114	183,81	9113	183,81	9399	211,12	9400	211,12
75,0 / 76,1	16,0	94	216,59	98	216,59	100605	251,17	101302	251,17
90,0 / 88,9	16,0	91	234,78	422	234,78	40458	267,56	420	267,56
110,0 / 108,0	16,0	424	262,09	426	262,09	101504	296,66	104793	296,66
110,0 / 114,3	16,0	14954	331,24	14956	331,24	100606	373,14	101041	373,14
114,3 / 114,3	16,0	428	274,84	430	274,84	442	309,42	443	309,42
140,0 / 139,7	16,0	432	425,89	434	425,89	40500	480,51	40501	480,51
160,0 / 159,0	16,0	436	473,22	438	473,22	40502	527,84	40503	527,84
160,0 / 168,3	16,0					102727	527,85	102726	527,85
200,0 / 206,0	16,0	102704	615,18	102705	615,18	101839	673,45	102196	673,45
225,0 / 219,1	10,0	102707	649,77	102708	649,77	102706	709,81	102709	709,81
225,0 / 229,0	10,0	102881	649,77	102880	649,77	102035	709,81	102879	709,81
250,0 / 256,0	10,0	102715	687,99	102713	687,99	102225	746,24	102712	746,24
315,0 / 323,9	10,0	102714	786,29	102716	786,29	102569	844,55	102717	844,55
355,0 / 355,6	6,0	102721	848,17	102720	848,17	102719	906,43	102718	906,43

Acoplamiento para transiciones de tubos plásticos a metálicos con anclaje axial.
En tubos plásticos es necesario incorporar el anillo de refuerzo "stiffening ring".

Junta: EPDM: -20°C hasta +100°C NBR: -20°C hasta +80°C
Fluido: EPDM: Todas las calidades de agua, aguas residuales, aire, sólidos y diversos productos químicos.
NBR: Agua, gas, aceite, combustible y otros hidrocarburos.



INDUSTRIA

Accesorios mecánicos para la unión de tuberías

Acoplamientos para tubos de cualquier material



J1

FLEX 1

CARCASA EN ACERO GALVANIZADO

diámetro exterior	PN (bar)	PN (bar)	Ref. EPDM	€ EPDM	Ref. NBR	€ NBR	Ref. FKM (1)	€ FKM
48,3	25,0	16,0	30001	74,63	30003	74,63		
54,0	25,0	16,0	30051	76,44	30053	76,44		
57,0	25,0	16,0	30101	77,19	30103	77,19		
60,3	25,0	16,0	30151	79,00	30153	79,00	30162	149,99
70,0	25,0	16,0	30194	89,55	30191	89,55	30196	174,20
73,0	25,0	16,0	30201	90,29	30203	90,29	30208	176,21
76,1	25,0	16,0	30251	90,98	30253	90,98	30258	178,20
80,0	25,0	16,0	102949	92,11	102950	92,11	102951	180,38
84,0	25,0	16,0	30301	93,00	30303	93,00	30314	181,84
88,9	25,0	16,0	30351	94,28	30353	94,28	30364	183,81
100,6	25,0	16,0	30401	97,01	30403	97,01	30411	187,47
101,6	25,0	16,0	30451	97,19	30453	97,19	30460	187,47
104,0	20,0	16,0	30501	97,56	30503	97,56	30511	189,29
104,8	20,0	16,0	30551	97,93	30553	97,93	30559	189,29
108,0	20,0	16,0	30601	98,64	30603	98,64	30613	191,12
114,3	20,0	16,0	30651	99,56	30653	99,56	30658	191,12
127,0	20,0	16,0	30676	129,97	30678	129,97	30679	229,35
129,0	20,0	16,0	30701	131,05	30703	131,05	30715	231,15
130,2	20,0	16,0	30751	131,58	30753	131,58	30754	232,98
133,0	16,0	16,0	30801	133,23	30803	133,23	30812	234,78
139,7	16,0	16,0	30851	135,22	30853	135,22	30867	243,90
141,3	16,0	16,0	30901	136,13	30903	136,13	30909	245,71
154,0	16,0	16,0	30951	139,80	30953	139,80	30963	262,09
159,0	16,0	16,0	31001	141,95	31003	141,95	31016	267,56
168,3	16,0	16,0	31051	145,44	31053	145,44	31075	278,48

Acoplamiento para tubos de cualquier material sin anclaje axial.
Acoplamiento de unión y compensador todo en uno.

(1) acoplamiento con anillo interior en acero inoxidable incorporado.

Junta: EPDM: -20°C hasta +100°C NBR: -20°C hasta +80°C FKM: -20°C hasta +180°C

Fluido: EPDM: Todas las calidades de agua, aguas residuales, aire, sólidos y diversos productos químicos.

NBR: Agua, gas, aceite, combustible y otros hidrocarburos.

FKM: Ozono, oxígeno, ácidos, gas, aceite y carburantes.



J1

FLEX 1

diámetro exterior	PN (bar)	PN (bar)	CARCASA EN ACERO INOXIDABLE					
			Ref. EPDM	€ EPDM	Ref. NBR	€ NBR	Ref. FKM(1)	€ FKM
48,3	25,0	16,0	30000	103,19	30002	103,19		
54,0	25,0	16,0	30050	105,58	30052	105,58		
57,0	25,0	16,0	30100	106,46	30102	106,46		
60,3	25,0	16,0	30150	107,57	30152	107,57	30166	178,20
70,0	25,0	16,0	30193	118,85	30195	118,85	30197	203,84
73,0	25,0	16,0	30200	119,41	30202	119,41	30216	205,66
76,1	25,0	16,0	30250	119,95	30252	119,95	30266	207,47
80,0	25,0	16,0	30318	121,40	100222	121,40	102948	209,33
84,0	24,0	16,0	30300	122,31	30302	122,31	30315	211,12
88,9	24,0	16,0	30350	123,41	30352	123,41	30366	212,96
100,6	23,0	16,0	30400	126,15	30402	126,15	30412	216,59
101,6	23,0	16,0	30450	126,30	30452	126,30	30461	216,59
104,0	22,0	16,0	30500	126,69	30502	126,69	30512	220,22
104,8	22,0	16,0	30550	126,85	30552	126,85	30560	220,22
108,0	22,0	16,0	30600	128,32	30602	128,32	30614	222,08
114,3	21,0	16,0	30650	129,23	30652	129,23	30666	222,08
127,0	19,0	16,0	30675	167,25	30677	167,25	30680	265,72
129,0	18,0	16,0	30700	168,34	30702	168,34	30716	267,56
130,2	18,0	16,0	30750	169,09	30752	169,09	30755	269,37
133,0	16,0	16,0	30800	170,17	30802	170,17	30813	271,20
139,7	16,0	16,0	30850	172,90	30852	172,90	30866	282,10
141,3	16,0	16,0	30900	173,27	30902	173,27	30908	283,95
154,0	16,0	16,0	30950	177,63	30952	177,63	30964	300,31
159,0	16,0	16,0	31000	179,63	31002	179,63	31017	305,78
168,3	16,0	16,0	31050	183,81	31052	183,81	31074	316,70

Acoplamiento para tubos de cualquier material sin anclaje axial. Acoplamiento de unión y compensador todo en uno.

(1) acoplamiento con anillo interior en acero inoxidable incorporado.
 Junta: EPDM: -20°C hasta +100°C NBR: -20°C hasta +80°C FKM: -20°C hasta +180°C
 Fluido: EPDM: Todas las calidades de agua, aguas residuales, aire, sólidos y diversos productos químicos.
 NBR: Agua, gas, aceite, combustible y otros hidrocarburos.
 FKM: Ozono, oxígeno, ácidos, gas, aceite y carburantes.

FLEX 2 PN 2,5  Consultar

J1

desde Ø exterior	hasta Ø exterior	Ref. EPDM	W1 CARCASA GALVANIZADA. CIERRES GALVANIZADOS			W2 CARCASA EN ACERO INOX. CIERRES GALVANIZADOS			W3 CARCASA EN ACERO INOX. CIERRES EN ACERO INOX.		
			€ EPDM	€ NBR	€ FKM (1)	€ EPDM	€ NBR	€ FKM (1)	€ EPDM	€ NBR	€ FKM (1)
172,0	199,0					372,14	372,14	547,15	443,02	443,02	618,03
200,0	224,0					383,23	383,23	587,00	454,12	454,12	657,89
225,0	249,0					392,08	392,08	631,31	462,98	462,98	702,20
250,0	274,0					405,37	405,37	677,84	476,26	476,26	748,72

Continúa en la página siguiente...

desde Ø exterior	hasta Ø exterior	Ref. EPDM	W1 CARCASA GALVANIZADA. CIERRES GALVANIZADOS			W2 CARCASA EN ACERO INOX. CIERRES GALVANIZADOS			W5 CARCASA EN ACERO INOX. CIERRES EN ACERO INOX.		
			€ EPDM	€ NBR	€ FKM (1)	€ EPDM	€ NBR	€ FKM (1)	€ EPDM	€ NBR	€ FKM (1)
275,0	299,0	F2020275W1E	673,40	673,40	952,50	412,01	412,01	724,34	482,88	482,88	795,23
300,0	324,0	F2020300W1E	684,48	684,48	1.001,23	427,52	427,52	766,43	498,39	498,39	837,30
325,0	349,0	F2020325W1E	695,54	695,54	1.054,39	436,38	436,38	812,94	507,26	507,26	883,84
350,0	374,0	F2020350W1E	706,63	706,63	1.098,71	447,45	447,45	857,26	518,35	518,35	928,15
375,0	399,0	F2020375W1E	717,72	717,72	1.151,86	456,32	456,32	901,53	527,22	527,22	972,43
400,0	424,0	F2020400W1E	733,20	733,20	1.205,01	465,16	465,16	945,86	536,05	536,05	1.016,74
425,0	449,0	F2020425W1E	744,28	744,28	1.247,13	478,46	478,46	992,38	549,34	549,34	1.063,25
450,0	474,0	F2020450W1E	755,37	755,37	1.293,63	491,77	491,77	1.038,89	562,64	562,64	1.109,78
475,0	499,0	F2020475W1E	768,66	768,66	1.340,13	507,26	507,26	1.080,99	578,15	578,15	1.151,86
500,0	524,0	F2020500W1E	777,51	777,51	1.384,46	520,54	520,54	1.127,48	591,42	591,42	1.198,37
525,0	549,0	F2020525W1E	795,23	795,23	1.435,40	533,86	533,86	1.171,80	604,75	604,75	1.242,68
550,0	574,0	F2020550W1E	817,37	817,37	1.493,00	544,92	544,92	1.218,32	615,80	615,80	1.289,20
575,0	599,0	F2020575W1E	835,11	835,11	1.541,72	560,43	560,43	1.262,64	631,31	631,31	1.333,52
600,0	624,0	F2020600W1E	883,84	883,84	1.590,47	660,11	660,11	1.371,17	731,00	731,00	1.442,05
625,0	649,0	F2020625W1E	901,53	901,53	1.650,26	666,74	666,74	1.419,88	737,63	737,63	1.490,77
650,0	674,0	F2020650W1E	919,30	919,30	1.699,01	682,26	682,26	1.464,20	753,17	753,17	1.535,09
675,0	699,0	F2020675W1E	937,00	937,00	1.747,74	699,96	699,96	1.510,72	770,86	770,86	1.581,60
700,0	724,0	F2020700W1E	959,15	959,15	1.800,90	715,50	715,50	1.555,04	786,38	786,38	1.625,93
725,0	749,0	F2020725W1E	976,86	976,86	1.847,42	737,63	737,63	1.601,54	808,52	808,52	1.672,44
750,0	799,0	F2020750W1E	992,38	992,38	1.873,99	872,76	872,76	1.672,44	943,66	943,66	1.743,32
800,0	849,0	F2020800W1E	1.032,27	1.032,27	1.922,75	903,78	903,78	1.763,22	974,66	974,66	1.834,11
850,0	899,0	F2020850W1E	1.065,49	1.065,49	1.971,45	934,76	934,76	1.854,06	1.005,67	1.005,67	1.924,94
900,0	949,0	F2020900W1E	1.105,35	1.105,35	2.071,14	970,23	970,23	1.949,31	1.041,13	1.041,13	2.020,20
950,0	999,0	F2020950W1E	1.140,80	1.140,80	2.175,25	1.001,23	1.001,23	2.040,15	1.072,11	1.072,11	2.111,03
1.000,0	1.049,0	F2021000W1E	1.174,03	1.174,03	2.270,51	1.036,69	1.036,69	2.130,94	1.107,57	1.107,57	2.201,82
1.050,0	1.099,0	F2021050W1E	1.216,11	1.216,11	2.361,31	1.078,76	1.078,76	2.221,78	1.149,66	1.149,66	2.292,66
1.100,0	1.149,0	F2021100W1E	1.249,33	1.249,33	2.441,06	1.125,29	1.125,29	2.314,80	1.196,18	1.196,18	2.385,68
1.150,0	1.199,0	F2021150W1E	1.287,00	1.287,00	2.527,46	1.169,60	1.169,60	2.407,83	1.240,45	1.240,45	2.478,70
1.200,0	1.249,0	F2021200W1E	1.324,66	1.324,66	2.616,06	1.213,88	1.213,88	2.498,65	1.284,78	1.284,78	2.569,53
1.250,0	1.299,0	F2021250W1E	1.364,52	1.364,52	2.706,88	1.258,22	1.258,22	2.591,68	1.329,09	1.329,09	2.662,59
1.300,0	1.349,0	F2021300W1E	1.402,18	1.402,18	2.795,48	1.300,29	1.300,29	2.682,52	1.371,17	1.371,17	2.753,40
1.350,0	1.399,0	F2021350W1E	1.442,05	1.442,05	2.884,09	1.344,57	1.344,57	2.773,37	1.415,45	1.415,45	2.844,24
1.400,0	1.449,0	F2021400W1E	1.479,71	1.479,71	2.974,92	1.386,65	1.386,65	2.866,36	1.457,53	1.457,53	2.937,25
1.450,0	1.499,0	F2021450W1E	1.519,58	1.519,58	3.063,51	1.430,96	1.430,96	2.959,39	1.501,85	1.501,85	3.030,30
1.500,0	1.549,0	F2021500W1E	1.557,22	1.557,22	3.152,11	1.880,63	1.880,63	3.475,54	1.955,94	1.955,94	3.550,86
1.550,0	1.600,0	F2021550W1E	1.597,12	1.597,12	3.242,95	1.933,80	1.933,80	3.579,67	2.009,11	2.009,11	3.654,99
1.600,0	1.649,0	F2021600W1E	1.636,96	1.636,96	3.331,56	1.989,16	1.989,16	3.683,76	2.064,48	2.064,48	3.759,07
1.650,0	1.699,0	F2021650W1E	1.674,63	1.674,63	3.420,14	2.044,57	2.044,57	3.790,09	2.119,90	2.119,90	3.865,40
1.700,0	1.749,0	F2021700W1E	1.714,51	1.714,51	3.508,77	2.099,94	2.099,94	3.894,19	2.175,25	2.175,25	3.969,50
1.750,0	1.799,0	F2021750W1E	1.752,18	1.752,18	3.597,37	2.153,13	2.153,13	4.000,52	2.228,45	2.228,45	4.075,84
1.800,0	1.849,0	F2021800W1E	1.792,02	1.792,02	3.685,97	2.208,49	2.208,49	4.104,63	2.283,81	2.283,81	4.179,95
1.850,0	1.899,0	F2021850W1E	1.829,68	1.829,68	3.776,79	2.263,85	2.263,85	4.208,75	2.339,18	2.339,18	4.284,06
1.900,0	1.949,0	F2021900W1E	1.869,57	1.869,57	3.865,40	2.317,04	2.317,04	4.315,07	2.392,35	2.392,35	4.390,39
1.950,0	1.999,0	F2021950W1E	1.907,23	1.907,23	3.954,01	2.372,40	2.372,40	4.419,18	2.447,72	2.447,72	4.494,50
2.000,0	2.032,0	F2022000W1E	1.947,09	1.947,09	4.042,61	2.427,77	2.427,77	4.523,27	2.503,07	2.503,07	4.598,59

Acoplamiento para tubos de cualquier material sin anclaje axial.

Acoplamiento de unión y compensador todo en uno.

Código W1 en NBR termina W1N
Código W1 en FKM termina W1F

Código W2 en EPDM termina W2E
Código W2 en NBR termina W2N
Código W2 en FKM termina W2F

Código W5 en EPDM termina W5E
Código W5 en NBR termina W5N
Código W5 en FKM termina W5F

(1) Los acoplamientos con la junta en FKM llevan incluido un anillo interior en acero inoxidable.

En caso de pedido indicar el diámetro exterior exacto.

Junta: EPDM: -20°C hasta +100°C NBR: -20°C hasta +80°C FKM: -20°C hasta +180°C

Fluido: EPDM: Todas las calidades de agua, aguas residuales, aire, sólidos y diversos productos químicos.

NBR: Agua, gas, aceite, combustible y otros hidrocarburos.

FKM: Ozono, oxígeno, ácidos, gas, aceite y carburantes.

Especificar 1 o 2 cierres

FLEX 2 PN 6

 Consultar

J1

desde Ø exterior	hasta Ø exterior	Ref. EPDM	W1 CARCASA GALVANIZADA. CIERRES GALVANIZADOS			W2 CARCASA EN ACERO INOX. CIERRES GALVANIZADOS			W5 CARCASA EN ACERO INOX. CIERRES EN ACERO INOX.		
			€ EPDM	€ NBR	€ FKM (1)	€ EPDM	€ NBR	€ FKM (1)	€ EPDM	€ NBR	€ FKM (1)
172,0	199,0					372,14	372,14	547,15	443,02	443,02	618,03
200,0	224,0					383,23	383,23	587,00	454,12	454,12	657,89
225,0	249,0					392,08	392,08	631,31	462,98	462,98	702,20
250,0	274,0					405,37	405,37	677,84	476,26	476,26	748,72
275,0	299,0	F2060275W1E	673,40	673,40	952,50	412,01	412,01	724,34	482,88	482,88	795,23
300,0	324,0	F2060300W1E	684,48	684,48	1.001,23	427,52	427,52	766,43	498,39	498,39	837,30
325,0	349,0	F2060325W1E	695,54	695,54	1.054,39	436,38	436,38	812,94	507,26	507,26	883,84
350,0	374,0	F2060350W1E	706,63	706,63	1.098,71	447,45	447,45	857,26	518,35	518,35	928,15
375,0	399,0	F2060375W1E	717,72	717,72	1.151,86	456,32	456,32	901,53	527,22	527,22	972,43
400,0	424,0	F2060400W1E	733,20	733,20	1.205,01	465,16	465,16	945,86	536,05	536,05	1.016,74
425,0	449,0	F2060425W1E	744,28	744,28	1.247,13	478,46	478,46	992,38	549,34	549,34	1.063,25
450,0	474,0	F2060450W1E	755,37	755,37	1.293,63	491,77	491,77	1.038,89	562,64	562,64	1.109,78
475,0	499,0	F2060475W1E	768,66	768,66	1.340,13	507,26	507,26	1.080,99	578,15	578,15	1.151,86
500,0	524,0	F2060500W1E	777,51	777,51	1.384,46	520,54	520,54	1.127,48	591,42	591,42	1.198,37
525,0	549,0	F2060525W1E	795,23	795,23	1.435,40	587,00	587,00	1.233,83	657,89	657,89	1.304,71
550,0	574,0	F2060550W1E	817,37	817,37	1.493,00	600,27	600,27	1.280,33	671,18	671,18	1.351,22
575,0	599,0	F2060575W1E	835,11	835,11	1.541,72	615,80	615,80	1.324,66	686,68	686,68	1.395,54
600,0	624,0	F2060600W1E	883,84	883,84	1.590,47	841,75	841,75	1.548,38	917,06	917,06	1.623,70
625,0	649,0	F2060625W1E	901,53	901,53	1.650,26	852,83	852,83	1.601,54	928,15	928,15	1.676,86
650,0	674,0	F2060650W1E	919,30	919,30	1.699,01	872,76	872,76	1.654,70	948,08	948,08	1.730,00
675,0	699,0	F2060675W1E	937,00	937,00	1.747,74	897,11	897,11	1.705,66	972,43	972,43	1.780,98
700,0	724,0	F2060700W1E	959,15	959,15	1.800,90	917,06	917,06	1.758,79	992,38	992,38	1.834,11
725,0	749,0	F2060725W1E	976,86	976,86	1.847,42	941,43	941,43	1.814,20	1.016,74	1.016,74	1.889,53
750,0	799,0	F2060750W1E	992,38	992,38	1.873,99	1.118,62	1.118,62	1.893,95	1.193,93	1.193,93	1.969,26
800,0	849,0	F2060800W1E	1.032,27	1.032,27	1.922,75	1.156,29	1.156,29	1.998,06	1.231,59	1.231,59	2.073,37

Acoplamiento para tubos de cualquier material sin anclaje axial.

Acoplamiento de unión y compensador todo en uno.

Código W1 en NBR termina W1N
Código W1 en FKM termina W1F

Código W2 en EPDM termina W2E
Código W2 en NBR termina W2N
Código W2 en FKM termina W2F

Código W5 en EPDM termina W5E
Código W5 en NBR termina W5N
Código W5 en FKM termina W5F

Continúa en la página siguiente...

J1

desde Ø exterior	hasta Ø exterior	Ref. EPDM	W1 CARCASA GALVANIZADA. CIERRES GALVANIZADOS			W2 CARCASA EN ACERO INOX. CIERRES GALVANIZADOS			W5 CARCASA EN ACERO INOX. CIERRES EN ACERO INOX.		
			€ EPDM	€ NBR	€ FKM (1)	€ EPDM	€ NBR	€ FKM (1)	€ EPDM	€ NBR	€ FKM (1)
850,0	899,0	F2060850W1E	1.065,49	1.065,49	1.971,45	1.198,37	1.198,37	2.104,38	1.273,69	1.273,69	2.179,70
900,0	949,0	F2060900W1E	1.105,35	1.105,35	2.071,14	1.240,45	1.240,45	2.208,49	1.315,77	1.315,77	2.283,81
950,0	999,0	F2060950W1E	1.140,80	1.140,80	2.175,25	1.282,58	1.282,58	2.314,80	1.357,89	1.357,89	2.390,12
1.000,0	1.049,0	F2061000W1E	1.174,03	1.174,03	2.270,51	1.324,66	1.324,66	2.421,15	1.399,98	1.399,98	2.496,46
1.050,0	1.099,0	F2061050W1E	1.216,11	1.216,11	2.361,31	1.380,03	1.380,03	2.525,27	1.455,35	1.455,35	2.600,58
1.100,0	1.149,0	F2061100W1E	1.249,33	1.249,33	2.441,06	1.439,82	1.439,82	2.631,57	1.515,15	1.515,15	2.706,88
1.150,0	1.199,0	F2061150W1E	1.287,00	1.287,00	2.527,46	1.497,43	1.497,43	2.737,89	1.572,74	1.572,74	2.813,20
1.200,0	1.249,0	F2061200W1E	1.324,66	1.324,66	2.616,06				2.615,91	2.615,91	5.066,15
1.250,0	1.299,0	F2061250W1E	1.364,52	1.364,52	2.706,88				2.683,68	2.683,68	5.219,28
1.300,0	1.349,0	F2061300W1E	1.402,18	1.402,18	2.795,58				2.754,00	2.754,00	5.372,41
1.350,0	1.399,0	F2061350W1E	1.442,05	1.442,05	2.884,09				2.826,79	2.826,79	5.528,07
1.400,0	1.449,0	F2061400W1E	1.479,71	1.479,71	2.974,92				2.899,60	2.899,60	5.686,22
1.450,0	1.499,0	F2061450W1E	1.519,58	1.519,58	3.063,51				2.977,42	2.977,42	5.846,88
1.500,0	1.549,0	F2061500W1E	1.557,22	1.557,22	3.152,11				3.052,74	3.052,74	6.010,08
1.550,0	1.600,0	F2061550W1E	1.597,12	1.597,12	3.242,95				3.133,08	3.133,08	6.173,28
1.600,0	1.649,0	F2061600W1E	1.636,96	1.636,96	3.331,56				3.213,41	3.213,41	6.341,46
1.650,0	1.699,0	F2061650W1E	1.674,63	1.674,63	3.420,14				3.298,77	3.298,77	6.509,66
1.700,0	1.749,0	F2061700W1E	1.714,51	1.714,51	3.508,77				3.384,10	3.384,10	6.677,87
1.750,0	1.799,0	F2061750W1E	1.752,18	1.752,18	3.597,37				3.474,50	3.474,50	6.853,60
1.800,0	1.849,0	F2061800W1E	1.792,02	1.792,02	3.685,97				3.785,81	3.785,81	7.247,73
1.850,0	1.899,0	F2061850W1E	1.829,68	1.829,68	3.776,79				3.886,21	3.886,21	7.431,03
1.900,0	1.949,0	F2061900W1E	2.686,95	2.686,95	4.685,02				3.989,15	3.989,15	7.619,31
1.950,0	1.999,0	F2061950W1E	2.742,32	2.742,32	4.789,11				4.097,11	4.097,11	7.812,61
2.000,0	2.032,0	F2062000W1E	2.797,73	2.797,73	4.893,20				4.205,04	4.205,04	8.003,42

Código W1 en NBR termina W1N
Código W1 en FKM termina W1F

Código W2 en EPDM termina W2E
Código W2 en NBR termina W2N
Código W2 en FKM termina W2F

Código W5 en EPDM termina W5E
Código W5 en NBR termina W5N
Código W5 en FKM termina W5F

(1) Los acoplamientos con la junta en FKM llevan incluido un anillo interior en acero inoxidable.

En caso de pedido indicar el diámetro exterior exacto.

Junta: EPDM: -20°C hasta +100°C NBR: -20°C hasta +80°C FKM: -20°C hasta +180°C

Fluido: EPDM: Todas las calidades de agua, aguas residuales, aire, sólidos y diversos productos químicos.

NBR: Agua, gas, aceite, combustible y otros hidrocarburos.

FKM: Ozono, oxígeno, ácidos, gas, aceite y carburantes.

Especificar 1 o 2 cierres

FLEX 2 PN 10  PN  Consultar

J1

desde Ø exterior	hasta Ø exterior	Ref. EPDM	W1 CARCASA GALVANIZADA. CIERRES GALVANIZADOS			W2 CARCASA EN ACERO INOX. CIERRES GALVANIZADOS			W5 CARCASA EN ACERO INOX. CIERRES EN ACERO INOX.		
			€ EPDM	€ NBR	€ FKM (1)	€ EPDM	€ NBR	€ FKM (1)	€ EPDM	€ NBR	€ FKM (1)
172,0	199,0					372,14	372,14	547,15	443,02	443,02	618,03
200,0	224,0					383,23	383,23	587,00	454,12	454,12	657,89
225,0	249,0					392,08	392,08	631,31	462,98	462,98	702,20
250,0	274,0					405,37	405,37	677,84	476,26	476,26	748,72
275,0	299,0	F2100275W1E	673,40	673,40	952,50	456,32	456,32	775,29	527,22	527,22	846,17
300,0	324,0	F2100300W1E	684,48	684,48	1.001,23	467,40	467,40	821,80	538,28	538,28	892,69
325,0	349,0	F2100325W1E	695,54	695,54	1.054,39	478,46	478,46	866,11	549,34	549,34	937,00
350,0	374,0	F2100350W1E	706,63	706,63	1.098,71	629,09	629,09	1.021,18	704,41	704,41	1.096,48
375,0	399,0	F2100375W1E	717,72	717,72	1.151,86	640,17	640,17	1.074,34	715,50	715,50	1.149,66
400,0	424,0	F2100400W1E	733,20	733,20	1.205,01	655,67	655,67	1.127,48	731,00	731,00	1.202,81
425,0	449,0	F2100425W1E	744,28	744,28	1.247,13	675,59	675,59	1.180,67	750,91	750,91	1.255,97
450,0	474,0	F2100450W1E	755,37	755,37	1.293,63	693,35	693,35	1.231,59	768,66	768,66	1.306,91
475,0	499,0	F2100475W1E	768,66	768,66	1.340,13	713,25	713,25	1.284,78	788,57	788,57	1.360,09
500,0	524,0	F2100500W1E	777,51	777,51	1.384,46	731,00	731,00	1.337,95	806,32	806,32	1.413,26
525,0	549,0	F2100525W1E	795,23	795,23	1.435,40	753,17	753,17	1.391,08	828,46	828,46	1.466,39
550,0	574,0	F2100550W1E	817,37	817,37	1.493,00	768,66	768,66	1.444,26	843,97	843,97	1.519,58
575,0	599,0	F2100575W1E	835,11	835,11	1.541,72	788,57	788,57	1.497,43	863,88	863,88	1.572,74
600,0	624,0	F2100600W1E	883,84	883,84	1.590,47	841,75	841,75	1.548,38	917,06	917,06	1.623,70
625,0	649,0	F2100625W1E	901,53	901,53	1.650,26	852,83	852,83	1.601,54	928,15	928,15	1.676,86
650,0	674,0	F2100650W1E	919,30	919,30	1.699,01	872,76	872,76	1.654,70	948,08	948,08	1.730,00
675,0	699,0	F2100675W1E	937,00	937,00	1.747,74	897,11	897,11	1.705,66	972,43	972,43	1.780,98
700,0	724,0	F2100700W1E	959,15	959,15	1.800,90	917,06	917,06	1.758,79	992,38	992,38	1.834,11
725,0	749,0	F2100725W1E	976,86	976,86	1.847,42				2.023,47	2.023,47	3.630,14
750,0	799,0	F2100750W1E	992,38	992,38	1.873,99				2.053,58	2.053,58	3.745,63
800,0	849,0	F2100800W1E	1.032,27	1.032,27	1.922,75				2.088,70	2.088,70	3.866,13

Acoplamiento para tubos de cualquier material sin anclaje axial.
 Acoplamiento de unión y compensador todo en uno.

Código W1 en NBR termina W1N
 Código W1 en FKM termina W1F

Código W2 en EPDM termina W2E
 Código W2 en NBR termina W2N
 Código W2 en FKM termina W2F

Código W5 en EPDM termina W5E
 Código W5 en NBR termina W5N
 Código W5 en FKM termina W5F

Continúa en la página siguiente...

J1

desde Ø exterior	hasta Ø exterior	Ref. EPDM	W1 CARCASA GALVANIZADA. CIERRES GALVANIZADOS			W2 CARCASA EN ACERO INOX. CIERRES GALVANIZADOS			W5 CARCASA EN ACERO INOX. CIERRES EN ACERO INOX.		
			€ EPDM	€ NBR	€ FKM (1)	€ EPDM	€ NBR	€ FKM (1)	€ EPDM	€ NBR	€ FKM (1)
850,0	899,0	F2100850W1E	1.065,49	1.065,49	1.971,45				2.123,86	2.123,86	3.981,62
900,0	949,0	F2100900W1E	1.105,35	1.105,35	2.071,14				2.299,58	2.299,58	4.242,70
950,0	999,0	F2100950W1E	1.140,80	1.140,80	2.175,25				2.332,24	2.332,24	4.360,70
1.000,0	1.049,0	F2101000W1E	1.703,43	1.703,43	2.799,93				2.362,38	2.362,38	4.476,17
1.050,0	1.099,0	F2101050W1E	1.763,22	1.763,22	2.908,47				2.402,54	2.402,54	4.596,67
1.100,0	1.149,0	F2101100W1E	1.814,20	1.814,20	3.005,92				2.507,97	2.507,97	4.792,49
1.150,0	1.199,0	F2101150W1E	1.867,34	1.867,34	3.107,82				2.555,67	2.555,67	4.920,51
1.200,0	1.249,0	F2101200W1E	1.920,51	1.920,51	3.211,94						
1.250,0	1.299,0	F2101250W1E	1.975,88	1.975,88	3.318,26						
1.300,0	1.349,0	F2101300W1E	2.031,27	2.031,27	3.422,38						
1.350,0	1.399,0	F2101350W1E	2.084,43	2.084,43	3.526,48						
1.400,0	1.449,0	F2101400W1E	2.139,81	2.139,81	3.635,03						
1.450,0	1.499,0	F2101450W1E	2.195,20	2.195,20	3.739,14						
1.500,0	1.549,0	F2101500W1E	2.250,57	2.250,57	3.845,47						
1.550,0	1.600,0	F2101550W1E	2.303,76	2.303,76	3.949,58						
1.600,0	1.649,0	F2101600W1E	2.359,12	2.359,12	4.053,69						
1.650,0	1.699,0	F2101650W1E	2.414,49	2.414,49	4.160,00						
1.700,0	1.749,0	F2101700W1E	2.467,65	2.467,65	4.264,12						
1.750,0	1.799,0	F2101750W1E	2.523,02	2.523,02	4.368,24						
1.800,0	1.849,0	F2101800W1E	2.578,40	2.578,40	4.474,54						
1.850,0	1.899,0	F2101850W1E	2.633,77	2.633,77	4.578,64						
1.900,0	1.949,0	F2101900W1E	2.686,95	2.686,95	4.685,02						
1.950,0	1.999,0	F2101950W1E	2.742,32	2.742,32	4.789,11						
2.000,0	2.032,0	F2102000W1E	2.797,73	2.797,73	4.893,20						

Código W1 en NBR termina W1N
 Código W1 en FKM termina W1F

Código W5 en EPDM termina W5E
 Código W5 en NBR termina W5N
 Código W5 en FKM termina W5F

(1) Los acoplamientos con la junta en FKM llevan incluido un anillo interior en acero inoxidable.

En caso de pedido indicar el diámetro exterior exacto.

Junta: EPDM: -20°C hasta +100°C NBR: -20°C hasta +80°C FKM: -20°C hasta +180°C

Fluido: EPDM: Todas las calidades de agua, aguas residuales, aire, sólidos y diversos productos químicos.

NBR: Agua, gas, aceite, combustible y otros hidrocarburos.

FKM: Ozono, oxígeno, ácidos, gas, aceite y carburantes.

Especificar 1 o 2 cierres

FLEX 2 PN 16

 Consultar

J1

desde Ø exterior	hasta Ø exterior	Ref. EPDM	W1 CARCASA GALVANIZADA. CIERRES GALVANIZADOS			W2 CARCASA EN ACERO INOX. CIERRES GALVANIZADOS			W5 CARCASA EN ACERO INOX. CIERRES EN ACERO INOX.		
			€ EPDM	€ NBR	€ FKM (1)	€ EPDM	€ NBR	€ FKM (1)	€ EPDM	€ NBR	€ FKM (1)
172,0	199,0					607,84	607,84	595,86	478,46	478,46	666,74
200,0	224,0					648,53	648,53	635,74	493,98	493,98	706,62
225,0	249,0					772,79	772,79	757,56	629,09	629,09	832,88
250,0	274,0					827,04	827,04	810,74	646,85	646,85	886,06
275,0	299,0	F2160275W1E	673,40	673,40	952,50	584,79	584,79	861,68	660,11	660,11	937,00
300,0	324,0	F2160300W1E	684,48	684,48	1.001,23	600,27	600,27	917,06	675,59	675,59	992,38
325,0	349,0	F2160325W1E	695,54	695,54	1.054,39	611,35	611,35	970,23	686,68	686,68	1.045,55
350,0	374,0	F2160350W1E	706,63	706,63	1.098,71	629,09	629,09	1.021,18	704,41	704,41	1.096,48
375,0	399,0	F2160375W1E	717,72	717,72	1.151,86	640,17	640,17	1.074,34	715,50	715,50	1.149,66
400,0	424,0	F2160400W1E	733,20	733,20	1.205,01	655,67	655,67	1.127,48	731,00	731,00	1.202,81
425,0	449,0	F2160425W1E	744,28	744,28	1.247,13				1.749,80	1.749,80	2.851,91
450,0	474,0	F2160450W1E	755,37	755,37	1.293,63				1.769,89	1.769,89	2.912,15
475,0	499,0	F2160475W1E	768,66	768,66	1.340,13				1.784,96	1.784,96	2.967,37
500,0	524,0	F2160500W1E	777,51	777,51	1.384,46				1.800,02	1.800,02	3.027,64
525,0	549,0	F2160525W1E	795,23	795,23	1.435,40				1.815,08	1.815,08	3.085,39
550,0	574,0	F2160550W1E	817,37	817,37	1.493,00				1.830,13	1.830,13	3.140,60
575,0	599,0	F2160575W1E	835,11	835,11	1.541,72				1.845,21	1.845,21	3.200,86
600,0	624,0	F2160600W1E	883,84	883,84	1.590,47				1.900,43	1.900,43	3.296,27
625,0	649,0	F2160625W1E	1.306,91	1.306,91	2.055,63				1.915,48	1.915,48	3.356,54
650,0	674,0	F2160650W1E	1.335,72	1.335,72	2.115,46				1.933,07	1.933,07	3.416,76
675,0	699,0	F2160675W1E	1.360,09	1.360,09	2.170,82				1.953,14	1.953,14	3.474,50
700,0	724,0	F2160700W1E	1.386,65	1.386,65	2.228,45				2.005,87	2.005,87	3.569,90
725,0	749,0	F2160725W1E	1.415,45	1.415,45	2.286,01				2.023,47	2.023,47	3.630,14
750,0	799,0	F2160750W1E	1.437,64	1.437,64	2.341,41				2.053,58	2.053,58	3.745,63
800,0	849,0	F2160800W1E	1.497,43	1.497,43	2.396,77				2.088,70	2.088,70	3.866,13
850,0	899,0	F2160850W1E	1.546,18	1.546,18	2.452,14						
900,0	949,0	F2160900W1E	1.601,54	1.601,54	2.569,53						
950,0	999,0	F2160950W1E	1.654,70	1.654,70	2.686,95						
1.000,0	1.049,0	F2161000W1E	1.703,43	1.703,43	2.799,93						
1.050,0	1.099,0	F2161050W1E	1.763,22	1.763,22	2.908,47						
1.100,0	1.149,0	F2161100W1E	1.814,20	1.814,20	3.005,92						
1.150,0	1.199,0	F2161150W1E	1.867,34	1.867,34	3.107,82						
1.200,0	1.249,0	F2161200W1E	1.920,51	1.920,51	3.211,94						
1.250,0	1.299,0	F2161250W1E	1.975,88	1.975,88	3.318,26						
1.300,0	1.349,0	F2161300W1E	2.031,27	2.031,27	3.422,38						
1.350,0	1.399,0	F2161350W1E	2.084,43	2.084,43	3.526,48						
1.400,0	1.449,0	F2161400W1E	2.139,81	2.139,81	3.635,03						
1.450,0	1.499,0	F2161450W1E	2.195,20	2.195,20	3.739,14						

Acoplamiento para tubos de cualquier material sin anclaje axial.

Acoplamiento de unión y compensador todo en uno.

Código W1 en NBR termina W1N
Código W1 en FKM termina W1F

Código W2 en EPDM termina W2E
Código W2 en NBR termina W2N
Código W2 en FKM termina W2F

Código W5 en EPDM termina W5E
Código W5 en NBR termina W5N
Código W5 en FKM termina W5F

(1) Los acoplamientos con la junta en FKM llevan incluido un anillo interior en acero inoxidable.

En caso de pedido indicar el diámetro exterior exacto.

Junta: EPDM: -20°C hasta +100°C **NBR:** -20°C hasta +80°C **FKM:** -20°C hasta +180°C

Líquido: EPDM: Todas las calidades de agua, aguas residuales, aire, sólidos y diversos productos químicos.

NBR: Agua, gas, aceite, combustible y otros hidrocarburos.

FKM: Ozono, oxígeno, ácidos, gas, aceite y carburantes.

Especificar 1 o 2 cierres

FLEX 2 PN 20  PN  Consultar

J1

desde Ø exterior	hasta Ø exterior	Ref. EPDM	W1 CARCASA GALVANIZADA. CIERRES GALVANIZADOS			W2 CARCASA EN ACERO INOX. CIERRES GALVANIZADOS			W5 CARCASA EN ACERO INOX. CIERRES EN ACERO INOX.		
			€ EPDM	€ NBR	€ FKM (1)	€ EPDM	€ NBR	€ FKM (1)	€ EPDM	€ NBR	€ FKM (1)
180,0	199,0					524,97	524,97	660,11	600,28	600,28	735,43
200,0	224,0					540,49	540,49	704,41	615,79	615,79	779,72
225,0	249,0					553,76	553,76	757,56	629,09	629,09	832,88
250,0	274,0					571,53	571,53	810,74	646,85	646,85	886,06
275,0	299,0	F2200275W1E	673,40	673,40	952,50	584,79	584,79	861,68	660,11	660,11	937,00
300,0	324,0	F2200300W1E	684,48	684,48	1.001,23	600,27	600,27	917,06	675,59	675,59	992,38
325,0	349,0	F2200325W1E	695,54	695,54	1.054,39				1.689,54	1.689,54	2.618,44
350,0	374,0	F2200350W1E	706,63	706,63	1.098,71				1.702,10	1.702,10	2.676,17
375,0	399,0	F2200375W1E	717,72	717,72	1.151,86				1.722,19	1.722,19	2.738,93
400,0	424,0	F2200400W1E	733,20	733,20	1.205,01				1.734,73	1.734,73	2.794,17
425,0	449,0	F2200425W1E	744,28	744,28	1.247,13				1.749,80	1.749,80	2.851,91
450,0	474,0	F2200450W1E	755,37	755,37	1.293,63				1.769,89	1.769,89	2.912,15
475,0	499,0	F2200475W1E	1.114,20	1.114,20	1.683,48				1.784,96	1.784,96	2.967,37
500,0	524,0	F2200500W1E	1.127,48	1.127,48	1.734,47				1.800,02	1.800,02	3.027,64
525,0	549,0	F2200525W1E	1.151,86	1.151,86	1.792,02				1.815,08	1.815,08	3.085,39
550,0	574,0	F2200550W1E	1.185,09	1.185,09	1.858,48				1.830,13	1.830,13	3.140,60
575,0	599,0	F2200575W1E	1.209,45	1.209,45	1.916,10				1.845,21	1.845,21	3.200,86
600,0	624,0	F2200600W1E	1.280,33	1.280,33	1.986,98				1.900,43	1.900,43	3.296,27
625,0	649,0	F2200625W1E	1.306,91	1.306,91	2.055,63				1.915,48	1.915,48	3.356,54
650,0	674,0	F2200650W1E	1.335,72	1.335,72	2.115,46						
675,0	699,0	F2200675W1E	1.360,09	1.360,09	2.170,82						
700,0	724,0	F2200700W1E	1.386,65	1.386,65	2.228,45						
725,0	749,0	F2200725W1E	1.415,45	1.415,45	2.286,01						
750,0	799,0	F2200750W1E	1.437,64	1.437,64	2.341,41						
800,0	849,0	F2200800W1E	1.497,43	1.497,43	2.396,77						
850,0	899,0	F2200850W1E	1.546,18	1.546,18	2.452,14						
900,0	949,0	F2200900W1E	1.601,54	1.601,54	2.569,53						
950,0	999,0	F2200950W1E	1.654,70	1.654,70	2.686,95						

Acoplamiento para tubos de cualquier material sin anclaje axial.

Acoplamiento de unión y compensador todo en uno.

Código W1 en NBR termina W1N
Código W1 en FKM termina W1F

Código W2 en EPDM termina W2E
Código W2 en NBR termina W2N
Código W2 en FKM termina W2F

Código W5 en EPDM termina W5E
Código W5 en NBR termina W5N
Código W5 en FKM termina W5F

(1) Los acoplamientos con la junta en FKM llevan incluido un anillo interior en acero inoxidable.

En caso de pedido indicar el diámetro exterior exacto.

Junta: EPDM: -20°C hasta +100°C NBR: -20°C hasta +80°C FKM: -20°C hasta +180°C

Fluido: EPDM: Todas las calidades de agua, aguas residuales, aire, sólidos y diversos productos químicos.

NBR: Agua, gas, aceite, combustible y otros hidrocarburos.

FKM: Ozono, oxígeno, ácidos, gas, aceite y carburantes.

Especificar 1 o 2 cierres

FLEX 2 PN 25  PN  Consultar

J1

desde Ø exterior	hasta Ø exterior	Ref. EPDM	W1 CARCASA GALVANIZADA. CIERRES GALVANIZADOS			W2 CARCASA EN ACERO INOX. CIERRES GALVANIZADOS			W5 CARCASA EN ACERO INOX. CIERRES EN ACERO INOX.		
			€ EPDM	€ NBR	€ FKM (1)	€ EPDM	€ NBR	€ FKM (1)	€ EPDM	€ NBR	€ FKM (1)
180,0	199,0					699,97	699,97	835,11	775,29	775,29	910,42
200,0	224,0					715,49	715,49	881,63	790,80	790,80	956,94
225,0	249,0					733,21	733,21	934,77	808,52	808,52	1.010,09
250,0	274,0					753,15	753,15	992,37	828,46	828,46	1.067,68
275,0	299,0	F2250275W1E	673,40	673,40	952,50				1.659,41	1.659,41	2.507,97
300,0	324,0	F2250300W1E	684,48	684,48	1.001,23				1.671,99	1.671,99	2.565,72
325,0	349,0	F2250325W1E	695,54	695,54	1.054,39				1.689,54	1.689,54	2.618,44
350,0	374,0	F2250350W1E	1.023,39	1.023,39	1.417,70				1.702,10	1.702,10	2.676,17
375,0	399,0	F2250375W1E	1.043,32	1.043,32	1.475,28				1.722,19	1.722,19	2.738,93
400,0	424,0	F2250400W1E	1.061,06	1.061,06	1.532,84				1.734,73	1.734,73	2.794,17
425,0	449,0	F2250425W1E	1.078,76	1.078,76	1.583,83				1.749,80	1.749,80	2.851,91
450,0	474,0	F2250450W1E	1.094,29	1.094,29	1.632,54				1.769,89	1.769,89	2.912,15
475,0	499,0	F2250475W1E	1.114,20	1.114,20	1.683,48				1.784,96	1.784,96	2.967,37
500,0	524,0	F2250500W1E	1.127,48	1.127,48	1.734,47				1.800,02	1.800,02	3.027,64
525,0	549,0	F2250525W1E	1.151,86	1.151,86	1.792,02						
550,0	574,0	F2250550W1E	1.185,09	1.185,09	1.858,48						
575,0	599,0	F2250575W1E	1.209,45	1.209,45	1.916,10						
600,0	624,0	F2250600W1E	1.280,33	1.280,33	1.986,98						
625,0	649,0	F2250625W1E	1.306,91	1.306,91	2.055,63						
650,0	674,0	F2250650W1E	1.335,72	1.335,72	2.115,46						
675,0	699,0	F2250675W1E	1.360,09	1.360,09	2.170,82						
700,0	724,0	F2250700W1E	1.386,65	1.386,65	2.228,45						
725,0	749,0	F2250725W1E	1.415,45	1.415,45	2.286,01						

Acoplamiento para tubos de cualquier material sin anclaje axial.

Acoplamiento de unión y compensador todo en uno.

Código W1 en NBR termina W1N
Código W1 en FKM termina W1F

Código W2 en EPDM termina W2E
Código W2 en NBR termina W2N
Código W2 en FKM termina W2F

Código W5 en EPDM termina W5E
Código W5 en NBR termina W5N
Código W5 en FKM termina W5F

(1) Los acoplamientos con la junta en FKM llevan incluido un anillo interior en acero inoxidable.

En caso de pedido indicar el diámetro exterior exacto.

Junta: EPDM: -20°C hasta +100°C NBR: -20°C hasta +80°C FKM: -20°C hasta +180°C

Fluido: EPDM: Todas las calidades de agua, aguas residuales, aire, sólidos y diversos productos químicos.

NBR: Agua, gas, aceite, combustible y otros hidrocarburos.

FKM: Ozono, oxígeno, ácidos, gas, aceite y carburantes.

Especificar 1 o 2 cierres



FLEX 3 PN 2,5



Consultar

J1

desde Ø exterior	hasta Ø exterior	W1 CARCASA GALVANIZADA. CIERRES GALVANIZADOS			W2 CARCASA EN ACERO INOX. CIERRES GALVANIZADOS		W5 CARCASA EN ACERO INOX. CIERRES EN ACERO INOX.	
		Ref. EPDM	€ EPDM	€ NBR	€ EPDM	€ NBR	€ EPDM	€ NBR
219,1	249,0				1.408,83	1.789,83	1.577,16	1.958,17
250,0	299,0				1.464,20	1.858,47	1.632,55	2.026,84
300,0	349,0	F3020300W1E	1.240,45	1.674,63	1.165,13	1.608,17	1.333,52	1.776,55
350,0	399,0	F3020350W1E	1.287,00	1.736,66	1.233,83	1.703,43	1.402,18	1.871,77
400,0	449,0	F3020400W1E	1.333,52	1.798,68	1.302,50	1.798,68	1.470,86	1.967,04
450,0	499,0	F3020450W1E	1.377,80	1.858,48	1.371,17	1.891,72	1.539,51	2.060,06
500,0	549,0	F3020500W1E	1.424,31	1.920,51	1.439,82	1.986,98	1.608,17	2.155,31
550,0	599,0	F3020550W1E	1.468,62	1.982,55	1.508,52	2.080,00	1.676,86	2.248,35
600,0	649,0	F3020600W1E	1.515,15	2.044,57	1.577,16	2.177,46	1.745,52	2.345,83
650,0	699,0	F3020650W1E	1.563,90	2.111,03	1.648,04	2.272,71	1.816,42	2.441,06
700,0	749,0	F3020700W1E	1.603,75	2.164,17	1.716,72	2.367,97	1.885,08	2.536,33
750,0	799,0	F3020750W1E	1.652,49	2.228,45	1.783,16	2.461,00	1.951,53	2.629,33
800,0	849,0	F3020800W1E	1.699,01	2.294,87	1.851,87	2.558,44	2.020,20	2.726,84
850,0	899,0	F3020850W1E	1.752,18	2.365,76	1.920,51	2.651,52	2.088,85	2.819,85
900,0	949,0	F3020900W1E	1.807,54	2.438,86	1.986,98	2.742,32	2.155,31	2.910,68
950,0	999,0	F3020950W1E	1.860,74	2.514,17	2.057,86	2.839,80	2.226,19	3.008,12
1.000,0	1.049,0	F3021000W1E	1.916,10	2.587,26	2.122,08	2.926,17	2.290,43	3.094,55
1.050,0	1.099,0	F3021050W1E	1.973,67	2.664,81	2.192,98	3.025,86	2.361,31	3.194,19
1.100,0	1.149,0	F3021100W1E	2.026,83	2.735,69	2.261,66	3.121,11	2.430,02	3.289,45
1.150,0	1.199,0	F3021150W1E	2.071,14	2.797,73	2.330,33	3.214,16	2.498,65	3.382,49
1.200,0	1.249,0	F3021200W1E	2.135,37	2.884,09	2.372,40	3.273,94	2.540,75	3.442,33
1.250,0	1.299,0	F3021250W1E	2.201,82	2.972,68	2.418,92	3.338,19	2.587,26	3.506,55
1.300,0	1.349,0	F3021300W1E	2.266,10	3.059,09	2.461,00	3.398,00	2.629,33	3.566,35
1.350,0	1.399,0	F3021350W1E	2.332,51	3.147,68	2.507,53	3.462,24	2.675,88	3.630,60
1.400,0	1.449,0	F3021400W1E	2.396,77	3.236,29	2.556,28	3.526,48	2.724,60	3.694,83
1.450,0	1.499,0	F3021450W1E	2.458,80	3.320,50	2.613,85	3.606,24	2.782,21	3.774,57
1.500,0	1.549,0	F3021500W1E	2.525,27	3.409,08	2.673,67	3.690,40	2.842,00	3.858,74
1.550,0	1.599,0	F3021550W1E	2.587,26	3.493,27	2.892,94	3.993,89	3.061,33	4.162,24
1.600,0	1.649,0	F3021600W1E	2.644,86	3.570,78	2.957,20	4.080,26	3.125,55	4.248,59
1.650,0	1.699,0	F3021650W1E	2.704,65	3.650,51	3.019,23	4.166,66	3.187,57	4.335,00
1.700,0	1.749,0	F3021700W1E	2.757,83	3.723,64	3.081,23	4.250,83	3.249,60	4.419,18
1.750,0	1.799,0	F3021750W1E	2.826,52	3.816,66	3.236,29	4.465,70	3.404,67	4.634,05
1.800,0	1.849,0	F3021800W1E	2.899,60	3.914,11	3.309,40	4.565,39	3.477,74	4.733,72
1.850,0	1.899,0	F3021850W1E	2.970,48	4.011,61	3.373,63	4.656,21	3.542,01	4.824,54
1.900,0	1.949,0	F3021900W1E	3.043,58	4.109,05	3.442,33	4.749,22	3.610,67	4.917,57
1.950,0	1.999,0	F3021950W1E	3.118,88	4.208,75	3.510,98	4.846,70	3.679,32	5.015,06
2.000,0	2.032,0	F3022000W1E	3.194,19	4.312,88	3.597,37	4.964,10	3.765,71	5.132,46

Acoplamiento para tubos de cualquier material sin anclaje axial.

Acoplamiento de unión y compensador todo en uno.

Código W1 en NBR termina W1N

Código W2 en EPDM termina W2E

Código W2 en NBR termina W2N

Código W5 en EPDM termina W5E

Código W5 en NBR termina W5N

En caso de pedido indicar el diámetro exterior exacto.

Junta: EPDM: -20°C hasta +100°C NBR: -20°C hasta +80°C

Fluido: EPDM: Todas las calidades de agua, aguas residuales, aire, sólidos y diversos productos químicos.

NBR: Agua, gas, aceite, combustible y otros hidrocarburos.

Especificar 1 o 2 cierres



FLEX 3 PN 6

 PN
  Consultar

J1

desde Ø exterior	hasta Ø exterior	W1 CARCASA GALVANIZADA. CIERRES GALVANIZADOS			W2 CARCASA EN ACERO INOX. CIERRES GALVANIZADOS		W5 CARCASA EN ACERO INOX. CIERRES EN ACERO INOX.	
		Ref. EPDM	€ EPDM	€ NBR	€ EPDM	€ NBR	€ EPDM	€ NBR
219,1	249,0				1.408,83	1.789,83	1.577,16	1.958,17
250,0	299,0				1.464,20	1.858,47	1.632,55	2.026,84
300,0	349,0	F3060300W1E	1.240,45	1.674,63	1.165,13	1.608,17	1.333,52	1.776,55
350,0	399,0	F3060350W1E	1.287,00	1.736,66	1.233,83	1.703,43	1.402,18	1.871,77
400,0	449,0	F3060400W1E	1.333,52	1.798,68	1.302,50	1.798,68	1.470,86	1.967,04
450,0	499,0	F3060450W1E	1.377,80	1.858,48	1.371,17	1.891,72	1.539,51	2.060,06
500,0	549,0	F3060500W1E	1.424,31	1.920,51	1.439,82	1.986,98	1.608,17	2.155,31
550,0	599,0	F3060550W1E	1.468,62	1.982,55	1.508,52	2.080,00	1.676,86	2.248,35
600,0	649,0	F3060600W1E	1.515,15	2.044,57	1.577,16	2.177,46	1.745,52	2.345,83
650,0	699,0	F3060650W1E	1.563,90	2.111,03	1.648,04	2.272,71	1.816,42	2.441,06
700,0	749,0	F3060700W1E	1.603,75	2.164,17	1.716,72	2.367,97	1.885,08	2.536,33
750,0	799,0	F3060750W1E	1.652,49	2.228,45	1.783,16	2.461,00	1.951,53	2.629,33
800,0	849,0	F3060800W1E	1.699,01	2.294,87	1.851,87	2.558,44	2.020,20	2.726,84
850,0	899,0	F3060850W1E	1.752,18	2.365,76	1.920,51	2.651,52	2.088,85	2.819,85
900,0	949,0	F3060900W1E	1.807,54	2.438,86	1.986,98	2.742,32	2.155,31	2.910,68
950,0	999,0	F3060950W1E	1.860,74	2.514,17	2.057,86	2.839,80	2.226,19	3.008,12
1.000,0	1.049,0	F3061000W1E	1.916,10	2.587,26			3.283,71	3.487,05
1.050,0	1.099,0	F3061050W1E	1.973,67	2.664,81			3.346,44	3.557,34
1.100,0	1.149,0	F3061100W1E	2.026,83	2.735,69			3.406,70	3.625,14
1.150,0	1.199,0	F3061150W1E	2.071,14	2.797,73			3.474,50	3.707,97
1.200,0	1.249,0	F3061200W1E	2.135,37	2.884,09			3.547,31	3.788,31
1.250,0	1.299,0	F3061250W1E	2.201,82	2.972,68			3.620,11	3.868,66
1.300,0	1.349,0	F3061300W1E	2.266,10	3.059,09			3.690,40	3.948,99
1.350,0	1.399,0	F3061350W1E	2.332,51	3.147,68			3.763,21	4.029,30
1.400,0	1.449,0	F3061400W1E	2.396,77	3.236,29			3.825,97	4.104,63
1.450,0	1.499,0	F3061450W1E	2.458,80	3.320,50			3.916,35	4.205,04
1.500,0	1.549,0	F3061500W1E	2.525,27	3.409,08			4.001,68	4.297,94
1.550,0	1.599,0	F3061550W1E	2.587,26	3.493,27			4.069,49	4.375,76
1.600,0	1.649,0	F3061600W1E	2.644,86	3.570,78			4.144,80	4.458,60
1.650,0	1.699,0	F3061650W1E	2.704,65	3.650,51			4.230,16	4.554,02
1.700,0	1.749,0	F3061700W1E	2.757,83	3.723,64			4.315,52	4.649,39
1.750,0	1.799,0	F3061750W1E	2.826,52	3.816,66			4.400,85	4.742,31
1.800,0	1.849,0	F3061800W1E	2.899,60	3.914,11			4.719,71	5.071,14
1.850,0	1.899,0	F3061850W1E	2.970,48	4.011,61			4.784,97	5.146,46
1.900,0	1.949,0	F3061900W1E	3.043,58	4.109,05			4.845,20	5.216,78
1.950,0	1.999,0	F3061950W1E	3.118,88	4.208,75			4.925,55	5.304,62
2.000,0	2.032,0	F3062000W1E	3.194,19	4.312,88			5.010,92	5.400,03

Acoplamiento para tubos de cualquier material sin anclaje axial.

Acoplamiento de unión y compensador todo en uno.

Código W1 en NBR termina W1N

Código W2 en EPDM termina W2E

Código W2 en NBR termina W2N

Código W5 en EPDM termina W5E

Código W5 en NBR termina W5N

En caso de pedido indicar el diámetro exterior exacto.

Junta: EPDM: -20°C hasta +100°C NBR: -20°C hasta +80°C

Fluido: EPDM: Todas las calidades de agua, aguas residuales, aire, sólidos y diversos productos químicos.

NBR: Agua, gas, aceite, combustible y otros hidrocarburos.

Especificar 1 o 2 cierres

FLEX 3 PN 10

 Consultar

J1

desde Ø exterior	hasta Ø exterior	W1 CARCASA GALVANIZADA. CIERRES GALVANIZADOS			W2 CARCASA EN ACERO INOX. CIERRES GALVANIZADOS		W5 CARCASA EN ACERO INOX. CIERRES EN ACERO INOX.	
		Ref. EPDM	€ EPDM	€ NBR	€ EPDM	€ NBR	€ EPDM	€ NBR
219,1	249,0				1.408,83	1.789,83	1.577,16	1.958,17
250,0	299,0				1.464,20	1.858,47	1.632,55	2.026,84
300,0	349,0	F3100300W1E	1.240,45	1.674,63	1.165,13	1.608,17	1.333,52	1.776,55
350,0	399,0	F3100350W1E	1.287,00	1.736,66	1.233,83	1.703,43	1.402,18	1.871,77
400,0	449,0	F3100400W1E	1.333,52	1.798,68	1.302,50	1.798,68	1.470,86	1.967,04
450,0	499,0	F3100450W1E	1.377,80	1.858,48	1.371,17	1.891,72	1.539,51	2.060,06
500,0	549,0	F3100500W1E	1.424,31	1.920,51			2.417,58	2.523,02
525,0	549,0		-	-			-	-
550,0	599,0	F3100550W1E	1.468,62	1.982,55			2.528,05	2.643,53
575,0	599,0		-	-			-	-
600,0	649,0	F3100600W1E	1.515,15	2.044,57			2.656,10	2.784,14
650,0	699,0	F3100650W1E	1.563,90	2.111,03			2.716,34	2.854,41
700,0	749,0	F3100700W1E	1.603,75	2.164,17			2.776,59	2.924,69
750,0	799,0	F3100750W1E	1.652,49	2.228,45			2.841,85	3.000,02
800,0	849,0	F3100800W1E	1.699,01	2.294,87			2.912,15	3.077,85
850,0	899,0	F3100850W1E	1.752,18	2.365,76			3.052,74	3.228,49
900,0	949,0	F3100900W1E	1.807,54	2.438,86			3.140,60	3.326,40
950,0	999,0	F3100950W1E	1.860,74	2.514,17			3.213,41	3.406,70
1.000,0	1.049,0	F3101000W1E	1.916,10	2.587,26			3.283,71	3.487,05
1.050,0	1.099,0	F3101050W1E	1.973,67	2.664,81			3.346,44	3.557,34
1.100,0	1.149,0	F3101100W1E	2.026,83	2.735,69			3.406,70	3.625,14
1.150,0	1.199,0	F3101150W1E	2.071,14	2.797,73			3.474,50	3.707,97
1.200,0	1.249,0	F3101200W1E	2.135,37	2.884,09			3.547,31	3.788,31
1.250,0	1.299,0	F3101250W1E	4.968,25	5.563,23			3.620,11	3.868,66
1.300,0	1.349,0	F3101300W1E	5.056,10	5.663,64			3.690,40	3.948,99
1.350,0	1.399,0	F3101350W1E	5.151,50	5.769,07			3.763,21	4.029,30
1.400,0	1.449,0	F3101400W1E	5.246,91	5.874,52			3.825,97	4.104,63
1.450,0	1.499,0	F3101450W1E	5.339,78	5.979,96			Consultar	Consultar
1.500,0	1.549,0	F3101500W1E	5.435,21	6.087,91				
1.550,0	1.599,0	F3101550W1E	5.525,57	6.188,34				
1.600,0	1.649,0	F3101600W1E	5.620,95	6.293,78				
1.650,0	1.699,0	F3101650W1E	5.713,85	6.401,72				
1.700,0	1.749,0	F3101700W1E	5.809,22	6.509,66				
1.750,0	1.799,0	F3101750W1E	5.899,62	6.607,57				
1.800,0	1.849,0	F3101800W1E	5.995,02	6.715,54				
1.850,0	1.899,0	F3101850W1E	6.090,43	6.820,98				
1.900,0	1.949,0	F3101900W1E	6.185,80	6.926,43				
1.950,0	1.999,0	F3101950W1E	6.276,20	7.029,32				
2.000,0	2.032,0	F3102000W1E	6.364,06	7.127,24				

Acoplamiento para tubos de cualquier material sin anclaje axial.

Acoplamiento de unión y compensador todo en uno.

Código W1 en NBR termina W1N

Código W2 en EPDM termina W2E
Código W2 en NBR termina W2N

Código W5 en EPDM termina W5E
Código W5 en NBR termina W5N

En caso de pedido indicar el diámetro exterior exacto.

Junta: EPDM: -20°C hasta +100°C NBR: -20°C hasta +80°C

Fluido: EPDM: Todas las calidades de agua, aguas residuales, aire, sólidos y diversos productos químicos.

NBR: Agua, gas, aceite, combustible y otros hidrocarburos.

Especificar 1 o 2 cierres



FLEX 3 PN 16



Consultar

J1

desde Ø exterior	hasta Ø exterior	W1 CARCASA GALVANIZADA. CIERRES GALVANIZADOS			W2 CARCASA EN ACERO INOX. CIERRES GALVANIZADOS		W5 CARCASA EN ACERO INOX. CIERRES EN ACERO INOX.	
		Ref. EPDM	€ EPDM	€ NBR	€ EPDM	€ NBR	€ EPDM	€ NBR
219,1	249,0				1.408,83	1.789,83	1.577,16	1.958,17
250,0	299,0				1.464,20	1.858,47	1.632,55	2.026,84
300,0	349,0	F3160300W1E	1.240,45	1.674,63	1.165,13	1.608,17	1.333,52	1.776,55
350,0	399,0	F3160350W1E	1.287,00	1.736,66			2.113,83	2.189,15
375,0	399,0		-	-			-	-
400,0	449,0	F3160400W1E	1.333,52	1.798,68			2.211,75	2.299,58
425,0	449,0		-	-			-	-
450,0	499,0	F3160450W1E	1.377,80	1.858,48			2.312,14	2.410,08
475,0	499,0		-	-			-	-
500,0	549,0	F3160500W1E	1.424,31	1.920,51			2.417,58	2.523,02
525,0	549,0		-	-			-	-
550,0	599,0	F3160550W1E	1.468,62	1.982,55			2.528,05	2.643,53
575,0	599,0		-	-			-	-
600,0	649,0	F3160600W1E	1.515,15	2.044,57			2.656,10	2.784,14
650,0	699,0	F3160650W1E	1.563,90	2.111,03			2.716,34	2.854,41
700,0	749,0	F3160700W1E	1.603,75	2.164,17			2.776,59	2.924,69
750,0	799,0	F3160750W1E	4.031,81	4.516,37			2.841,85	3.000,02
800,0	849,0	F3160800W1E	4.122,21	4.616,79			2.912,15	3.077,85
850,0	899,0	F3160850W1E	4.217,60	4.722,21			Consultar	Consultar
900,0	949,0	F3160900W1E	4.305,47	4.822,62				
950,0	999,0	F3160950W1E	4.400,85	4.928,05				
1.000,0	1.049,0	F3161000W1E	4.496,26	5.033,50				
1.050,0	1.099,0	F3161050W1E	4.591,68	5.143,96				
1.100,0	1.149,0	F3161100W1E	4.679,51	5.241,88				
1.150,0	1.199,0	F3161150W1E	4.774,93	5.349,82				
1.200,0	1.249,0	F3161200W1E	4.872,84	5.455,26				
1.250,0	1.299,0	F3161250W1E	4.968,25	5.563,23				
1.300,0	1.349,0	F3161300W1E	5.056,10	5.663,64				
1.350,0	1.399,0	F3161350W1E	5.151,50	5.769,07				
1.400,0	1.449,0	F3161400W1E	5.246,91	5.874,52				
1.450,0	1.499,0	F3161450W1E	5.339,78	5.979,96				
1.500,0	1.549,0	F3161500W1E	5.435,21	6.087,91				
1.550,0	1.599,0	F3161550W1E	Consultar	Consultar				

Acoplamiento para tubos de cualquier material sin anclaje axial.

Acoplamiento de unión y compensador todo en uno.

Código W1 en NBR termina W1N

Código W2 en EPDM termina W2E

Código W5 en EPDM termina W5E

Código W2 en NBR termina W2N

Código W5 en NBR termina W5N

En caso de pedido indicar el diámetro exterior exacto.

Junta: EPDM: -20°C hasta +100°C NBR: -20°C hasta +80°C

Fluido: EPDM: Todas las calidades de agua, aguas residuales, aire, sólidos y diversos productos químicos.

NBR: Agua, gas, aceite, combustible y otros hidrocarburos.

Especificar 1 o 2 cierres

FLEX 3 PN 20  PN  Consultar

J1

W1 CARCASA GALVANIZADA. CIERRES GALVANIZADOS

W5 CARCASA EN ACERO INOX. CIERRES EN ACERO INOX.

desde Ø exterior	hasta Ø exterior	Ref. EPDM	€ EPDM	Ref. NBR	€ NBR	Ref. NBR	€ NBR	Ref. NBR	€ NBR
300,0	324,0					F3200300W5E	1.762,17	F3200300W5N	2.088,70
323,9	349,0	F3200323W1E	1.240,45	F3200323W1N	1.674,63				
325,0	349,0					F3200325W5E	2.063,62	F3200325W5N	2.138,93
350,0	399,0	F3200350W1E	1.287,00	F3200350W1N	1.736,66	F3200350W5E	2.113,83	F3200350W5N	2.189,15
375,0	399,0					F3200375W5E	2.161,52	F3200375W5N	2.244,38
400,0	449,0	F3200400W1E	1.333,52	F3200400W1N	1.798,68	F3200400W5E	2.211,75	F3200400W5N	2.299,58
425,0	449,0					F3200425W5E	2.259,43	F3200425W5N	2.352,30
450,0	499,0	F3200450W1E	1.377,80	F3200450W1N	1.858,49	F3200450W5E	2.312,14	F3200450W5N	2.410,08
475,0	499,0					F3200475W5E	2.364,88	F3200475W5N	2.467,80
500,0	549,0	F3200500W1E	1.424,31	F3200500W1N	1.920,51	F3200500W5E	2.417,58	F3200500W5N	2.523,02
525,0	549,0					F3200525W5E	2.472,80	F3200525W5N	2.583,28
550,0	599,0	F3200550W1E	3.682,88	F3200550W1N	4.124,73	F3200550W5E	2.528,05	F3200550W5N	2.643,53
575,0	599,0					F3200575W5E	2.585,78	F3200575W5N	2.703,79
600,0	649,0	F3200600W1E	3.753,15	F3200600W1N	4.202,54	F3200600W5E	2.656,10	F3200600W5N	2.784,14
650,0	699,0	F3200650W1E	3.848,55	F3200650W1N	4.310,48	F3200650W5E	Consultar	F3200650W5N	Consultar
700,0	749,0	F3200700W1E	3.938,95	F3200700W1N	4.408,38				
750,0	799,0	F3200750W1E	4.031,81	F3200750W1N	4.516,37				
800,0	849,0	F3200800W1E	4.122,21	F3200800W1N	4.616,76				
850,0	899,0	F3200850W1E	4.217,60	F3200850W1N	4.722,21				
900,0	949,0	F3200900W1E	4.305,47	F3200900W1N	4.822,62				
950,0	999,0	F3200950W1E	4.400,85	F3200950W1N	4.928,05				
1.000,0	1.049,0	F3201000W1E	4.496,26	F3201000W1N	5.033,50				
1.050,0	1.099,0	F3201050W1E	4.591,68	F3201050W1N	5.143,97				
1.100,0	1.149,0	F3201100W1E	4.679,51	F3201100W1N	5.241,88				
1.150,0	1.149,0	F3201150W1E	Consultar	F3201150W1N	Consultar				

Acoplamiento para tubos de cualquier material sin anclaje axial.
 Acoplamiento de unión y compensador todo en uno.

En caso de pedido indicar el diámetro exterior exacto.
 Junta: EPDM: -20°C hasta +100°C NBR: -20°C hasta +80°C
 Fluido: EPDM: Todas las calidades de agua, aguas residuales, aire, sólidos y diversos productos químicos.
 NBR: Agua, gas, aceite, combustible y otros hidrocarburos.
 Especificar 1 o 2 cierres

FLEX 3 PN 25

 PN
 
 Consultar

J1

W1 CARCASA GALVANIZADA. CIERRES GALVANIZADOS

W5 CARCASA EN ACERO INOX. CIERRES EN ACERO INOX.

desde Ø exterior	hasta Ø exterior	Ref. EPDM	€ EPDM	Ref. NBR	€ NBR	Ref. NBR	€ NBR	Ref. NBR	€ NBR
300,0	324,0					F3250300W5E	2.013,42	F3250300W5N	2.088,70
323,9	349,0	F3250323W1E	1.240,45	F3250323W1N	1.674,63	F3250323W5E	2.063,62	F3250323W5N	2.138,93
350,0	399,0	F3250350W1E	1.287,00	F3250350W1N	1.736,66	F3250350W5E	2.113,83	F3250350W5N	2.189,15
375,0	399,0					F3250375W5E	2.161,52	F3250375W5N	2.244,38
400,0	449,0	F3250400W1E	1.333,52	F3250400W1N	1.798,68	F3250400W5E	2.211,75	F3250400W5N	2.299,58
425,0	449,0					F3250425W5E	2.259,43	F3250425W5N	2.352,30
450,0	499,0	F3250450W1E	1.377,80	F3250450W1N	1.858,48	F3250450W5E	2.312,14	F3250450W5N	2.410,08
475,0	499,0					F3250475W5E	2.364,88	F3250475W5N	2.467,80
500,0	549,0					F3250500W5E	Consultar	F3250500W5N	Consultar
550,0	599,0	F3250550W1E	3.753,15	F3250550W1N	4.124,73				
600,0	649,0	F3250600W1E	3.848,55	F3250600W1N	4.202,54				
650,0	699,0	F3250650W1E	3.938,95	F3250650W1N	4.310,48				
700,0	749,0	F3250700W1E	4.031,81	F3250700W1N	4.408,38				
750,0	799,0	F3250750W1E	4.122,21	F3250750W1N	4.516,37				
800,0	849,0	F3250800W1E	4.217,60	F3250800W1N	4.616,79				
850,0	899,0	F3250850W1E	4.305,48	F3250850W1N	4.722,21				
900,0	949,0	F3250900W1E	4.305,47	F3250900W1N	4.822,62				
950,0	999,0	F3250950W1E	Consultar	F3250950W1N	Consultar				

Acoplamiento para tubos de cualquier material sin anclaje axial.
Acoplamiento de unión y compensador todo en uno.

En caso de pedido indicar el diámetro exterior exacto.
Junta: EPDM: -20°C hasta +100°C NBR: -20°C hasta +80°C
Fluido: EPDM: Todas las calidades de agua, aguas residuales, aire, sólidos y diversos productos químicos.
NBR: Agua, gas, aceite, combustible y otros hidrocarburos.
Especificar 1 o 2 cierres



OPEN FLEX 1

J1

diámetro exterior	PN (bar)	PN (bar)	CARCASA EN ACERO GALVANIZADO					
			Ref. EPDM	€ EPDM	Ref. NBR	€ NBR	Ref. FKM(1)	€ FKM
48,3	25,0	16,0	35001	109,22	35003	109,22	35009	178,20
54,0	25,0	16,0	35051	112,49	35053	112,49	35057	181,84
57,0	25,0	16,0	35101	114,32	35103	114,32	35106	185,64
60,3	25,0	16,0	35151	116,11	35153	116,11	35166	187,47
73,0	25,0	16,0	35201	126,30	35203	126,30	35213	211,12
76,1	25,0	16,0	35251	127,41	35253	127,41	35267	214,77
84,0	25,0	16,0	35301	130,32	35303	130,32	35309	220,22
88,9	25,0	16,0	35351	132,34	35353	132,34	35368	222,08
100,6	25,0	16,0	35401	135,98	35403	135,98	35411	227,50
101,6	25,0	16,0	35451	136,32	35453	136,32	35459	227,50
104,0	20,0	16,0	35501	136,68	35503	136,68	35514	229,35
104,8	20,0	16,0	35551	137,07	35553	137,07	35559	229,35
108,0	20,0	16,0	35601	138,52	35603	138,52	35614	231,15
114,3	20,0	16,0	35651	139,80	35653	139,80	35645	232,98
118,0	20,0	16,0	35671	140,70	35673	140,70	35636	247,53
127,0	20,0	16,0	35676	168,91	35678	168,91	35685	267,56
129,0	20,0	16,0	35701	169,81	35703	169,81	35709	269,37
130,2	20,0	16,0	35751	170,90	35753	170,90	35759	271,20
133,0	16,0	16,0	35801	173,10	35803	173,10	35814	273,00
139,7	16,0	16,0	35851	175,99	35853	175,99	35858	285,76
141,3	16,0	16,0	35901	176,37	35903	176,37	35912	287,58
154,0	16,0	16,0	35951	181,46	35953	181,46	35958	303,95
159,0	16,0	16,0	36001	183,81	36003	183,81	36016	311,26
168,3	16,0	16,0	36051	189,29	36053	189,29	36067	322,16

Acoplamiento abierto para tubos de cualquier material sin anclaje axial. Abierto con bisagra.

(1) acoplamiento con anillo interior en acero inoxidable incorporado.

Junta: EPDM: -20°C hasta +100°C NBR: -20°C hasta +80°C FKM: -20°C hasta +180°C

Fluido: EPDM: Todas las calidades de agua, aguas residuales, aire, sólidos y diversos productos químicos.

NBR: Agua, gas, aceite, combustible y otros hidrocarburos.

FKM: Ozono, oxígeno, ácidos, gas, aceite y carburantes.



J1

OPEN FLEX 1

diámetro exterior	PN (bar)	PN (bar)	CARCASA EN ACERO INOXIDABLE					
			Ref. EPDM	€ EPDM	Ref. NBR	€ NBR	Ref. FKM ⁽¹⁾	€ FKM
48,3	25,0	16,0	35000	138,15	35002	138,15	35007	205,66
54,0	25,0	16,0	35050	141,42	35052	141,42	35056	211,12
57,0	25,0	16,0	35100	142,51	35102	142,51	35108	212,96
60,3	25,0	16,0	35150	144,50	35152	144,50	35168	214,77
73,0	25,0	16,0	35200	155,42	35202	155,42	35209	242,07
76,1	25,0	16,0	35250	156,54	35252	156,54	35268	243,90
84,0	25,0	16,0	35300	159,43	35302	159,43	35308	247,53
88,9	25,0	16,0	35350	161,44	35352	161,44	35369	251,17
100,6	25,0	16,0	35400	164,91	35402	164,91	35410	254,81
101,6	25,0	16,0	35450	165,26	35452	165,26	35458	256,64
104,0	20,0	16,0	35500	165,83	35502	165,83	35515	256,64
104,8	20,0	16,0	35550	166,17	35552	166,17	35558	258,45
108,0	20,0	16,0	35600	167,25	35602	167,25	35609	260,28
114,3	20,0	16,0	35650	168,91	35652	168,91	35644	274,84
118,0	20,0	16,0	35670	169,81	35672	169,81	35635	262,09
127,0	20,0	16,0	35675	205,66	35677	205,66	35684	305,78
129,0	20,0	16,0	35700	207,47	35702	207,47	35708	307,59
130,2	20,0	16,0	35750	207,47	35752	207,47	35758	309,41
133,0	16,0	16,0	35800	209,33	35802	209,33	35813	311,26
139,7	16,0	16,0	35850	212,96	35852	212,96	35854	322,16
141,3	16,0	16,0	35900	212,96	35902	212,96	35911	322,16
154,0	16,0	16,0	35950	220,22	35952	220,22	35954	340,37
159,0	16,0	16,0	36000	223,88	36002	223,88	36015	349,47
168,3	16,0	16,0	36050	227,50	36052	227,50	36066	360,38

(1) acoplamiento con anillo interior en acero inoxidable incorporado.

Junta: EPDM: -20°C hasta +100°C NBR: -20°C hasta +80°C FKM: -20°C hasta +180°C

Fluido: EPDM: Todas las calidades de agua, aguas residuales, aire, sólidos y diversos productos químicos.

NBR: Agua, gas, aceite, combustible y otros hidrocarburos.

FKM: Ozono, oxígeno, ácidos, gas, aceite y carburantes.



J1

OPEN FLEX 2 PN 2,5

desde Ø exterior	hasta Ø exterior	Ref. EPDM	W1 CARCASA GALVANIZADA. CIERRES GALVANIZADOS			W2 CARCASA EN ACERO INOX. CIERRES GALVANIZADOS			W5 CARCASA EN ACERO INOX. CIERRES EN ACERO INOX.		
			€ EPDM	€ NBR	€ FKM (1)	€ EPDM	€ NBR	€ FKM (1)	€ EPDM	€ NBR	€ FKM (1)
172,0	199,0					513,92	513,92	688,91	584,80	584,80	759,79
200,0	224,0					531,64	531,64	735,43	602,52	602,52	806,31
225,0	249,0					542,71	542,71	781,94	613,59	613,59	852,83
250,0	274,0					558,20	558,20	830,70	629,09	629,09	901,53
275,0	299,0	OF2020275W1E	1.072,11	1.072,11	1.351,22	571,53	571,53	881,62	642,41	642,41	952,50
300,0	324,0	OF2020300W1E	1.089,82	1.089,82	1.408,84	589,24	589,24	928,15	660,11	660,11	999,02
325,0	349,0	OF2020325W1E	1.109,78	1.109,78	1.466,39	600,27	600,27	976,86	671,18	671,18	1.047,74
350,0	374,0	OF2020350W1E	1.127,48	1.127,48	1.519,58	618,02	618,02	1.030,04	688,93	688,93	1.100,91
375,0	399,0	OF2020375W1E	1.147,44	1.147,44	1.581,60	629,09	629,09	1.074,34	699,96	699,96	1.145,22
400,0	424,0	OF2020400W1E	1.165,13	1.165,13	1.639,21	640,17	640,17	1.123,05	711,05	711,05	1.193,93
425,0	449,0	OF2020425W1E	1.187,32	1.187,32	1.690,15	664,55	664,55	1.176,24	735,42	735,42	1.247,13
450,0	474,0	OF2020450W1E	1.205,01	1.205,01	1.743,32	677,85	677,85	1.222,75	748,72	748,72	1.293,63
475,0	499,0	OF2020475W1E	1.222,75	1.222,75	1.794,25	697,78	697,78	1.273,69	768,66	768,66	1.344,57
500,0	524,0	OF2020500W1E	1.240,45	1.240,45	1.847,42	715,50	715,50	1.322,43	786,38	786,38	1.393,32
525,0	549,0	OF2020525W1E	1.267,07	1.267,07	1.905,00	739,86	739,86	1.377,80	810,74	810,74	1.448,70
550,0	574,0	OF2020550W1E	1.302,50	1.302,50	1.978,12	753,17	753,17	1.426,54	824,04	824,04	1.497,43
575,0	599,0	OF2020575W1E	1.329,09	1.329,09	2.037,91	773,08	773,08	1.473,08	843,97	843,97	1.543,95
600,0	624,0	OF2020600W1E	1.408,84	1.408,84	2.115,46	894,93	894,93	1.605,96	965,81	965,81	1.676,86
625,0	649,0	OF2020625W1E	1.435,40	1.435,40	2.184,13	919,30	919,30	1.672,44	990,17	990,17	1.743,32
650,0	674,0	OF2020650W1E	1.466,39	1.466,39	2.248,35	941,43	941,43	1.725,58	1.012,32	1.012,32	1.796,46
675,0	699,0	OF2020675W1E	1.495,19	1.495,19	2.303,76	970,23	970,23	1.778,75	1.041,13	1.041,13	1.849,63
700,0	724,0	OF2020700W1E	1.526,24	1.526,24	2.367,97	987,93	987,93	1.827,48	1.058,83	1.058,83	1.898,38
725,0	749,0	OF2020725W1E	1.555,04	1.555,04	2.427,77	1.014,50	1.014,50	1.880,63	1.085,41	1.085,41	1.951,53
750,0	799,0	OF2020750W1E	1.579,38	1.579,38	2.463,23	1.205,01	1.205,01	2.002,50	1.275,91	1.275,91	2.073,37
800,0	849,0	OF2020800W1E	1.643,62	1.643,62	2.536,33	1.247,13	1.247,13	2.108,81	1.318,00	1.318,00	2.179,70

Acoplamiento abierto para tubos de cualquier material sin anclaje axial.
 Abierto con bisagra.

Código W1 en NBR termina W1N
 Código W1 en FKM termina W1F

Código W2 en EPDM termina W2E
 Código W2 en NBR termina W2N
 Código W2 en FKM termina W2F

Código W5 en EPDM termina W5E
 Código W5 en NBR termina W5N
 Código W5 en FKM termina W5F

Continúa en la página siguiente...

J1

desde Ø exterior	hasta Ø exterior	Ref. EPDM	W1 CARCASA GALVANIZADA. CIERRES GALVANIZADOS			W2 CARCASA EN ACERO INOX. CIERRES GALVANIZADOS			W5 CARCASA EN ACERO INOX. CIERRES EN ACERO INOX.		
			€ EPDM	€ NBR	€ FKM (1)	€ EPDM	€ NBR	€ FKM (1)	€ EPDM	€ NBR	€ FKM (1)
850,0	899,0	OF2020850W1E	1.701,23	1.701,23	2.607,20	1.291,44	1.291,44	2.210,69	1.362,32	1.362,32	2.281,58
900,0	949,0	OF2020900W1E	1.758,79	1.758,79	2.726,84	1.337,95	1.337,95	2.314,80	1.408,84	1.408,84	2.385,68
950,0	999,0	OF2020950W1E	1.818,62	1.818,62	2.853,10	1.380,03	1.380,03	2.418,92	1.450,92	1.450,92	2.489,80
1.000,0	1.049,0	OF2021000W1E	1.876,21	1.876,21	2.970,48	1.428,75	1.428,75	2.523,02	1.499,64	1.499,64	2.593,91
1.050,0	1.099,0	OF2021050W1E	1.942,67	1.942,67	3.087,89	1.488,59	1.488,59	2.631,57	1.559,47	1.559,47	2.702,46
1.100,0	1.149,0	OF2021100W1E	1.993,60	1.993,60	3.185,34	1.552,80	1.552,80	2.744,54	1.623,70	1.623,70	2.815,44
1.150,0	1.199,0	OF2021150W1E	2.053,43	2.053,43	3.293,88	1.614,84	1.614,84	2.853,10	1.685,72	1.685,72	2.923,99
1.200,0	1.249,0	OF2021200W1E	2.113,24	2.113,24	3.404,67	1.676,86	1.676,86	2.961,64	1.747,74	1.747,74	3.032,52
1.250,0	1.299,0	OF2021250W1E	2.173,04	2.173,04	3.513,21	1.738,88	1.738,88	3.072,36	1.809,76	1.809,76	3.143,25
1.300,0	1.349,0	OF2021300W1E	2.230,63	2.230,63	3.623,94	1.800,90	1.800,90	3.183,15	1.871,77	1.871,77	3.254,03
1.350,0	1.399,0	OF2021350W1E	2.290,43	2.290,43	3.732,49	1.860,74	1.860,74	3.291,70	1.931,61	1.931,61	3.362,57
1.400,0	1.449,0	OF2021400W1E	2.350,26	2.350,26	3.845,47	1.922,75	1.922,75	3.402,43	1.993,60	1.993,60	3.473,33
1.450,0	1.499,0	OF2021450W1E	2.410,08	2.410,08	3.954,01	1.984,74	1.984,74	3.513,21	2.055,63	2.055,63	3.584,10
1.500,0	1.549,0	OF2021500W1E	2.467,65	2.467,65	4.062,56	2.046,92	2.046,92	3.624,06	2.117,74	2.117,74	3.695,12
1.550,0	1.600,0	OF2021550W1E	2.527,46	2.527,46	4.173,28	2.110,41	2.110,41	3.734,06	2.182,74	2.182,74	3.806,38
1.600,0	1.649,0	OF2021600W1E	2.587,26	2.587,26	4.281,83	2.174,98	2.174,98	3.844,55	2.249,28	2.249,28	3.918,85
1.650,0	1.699,0	OF2021650W1E	2.647,10	2.647,10	4.392,60	2.240,48	2.240,48	3.954,00	2.317,81	2.317,81	4.032,31
1.700,0	1.749,0	OF2021700W1E	2.706,88	2.706,88	4.501,15	2.307,03	2.307,03	4.062,26	2.387,36	2.387,36	4.146,58
1.750,0	1.799,0	OF2021750W1E	2.764,48	2.764,48	4.611,89	2.374,55	2.374,55	4.170,76	2.458,86	2.458,86	4.261,08
1.800,0	1.849,0	OF2021800W1E	2.824,29	2.824,29	4.720,44	2.442,08	2.442,08	4.279,23	2.531,40	2.531,40	4.376,55
1.850,0	1.899,0	OF2021850W1E	2.884,09	2.884,09	4.831,21	2.510,62	2.510,62	4.382,49	2.604,91	2.604,91	4.492,81
1.900,0	1.949,0	OF2021900W1E	2.943,92	2.943,92	4.939,74	2.580,15	2.580,15	4.492,98	2.679,47	2.679,47	4.609,28
1.950,0	1.999,0	OF2021950W1E	3.001,49	3.001,49	5.048,30	2.650,65	2.650,65	4.604,44	2.755,98	2.755,98	4.726,74
2.000,0	2.032,0	OF2022000W1E	3.061,33	3.061,33	5.159,04	2.722,19	2.722,19	4.717,71	2.833,52	2.833,52	4.844,02

Código W1 en NBR termina W1N
Código W1 en FKM termina W1F

Código W2 en EPDM termina W2E
Código W2 en NBR termina W2N
Código W2 en FKM termina W2F

Código W5 en EPDM termina W5E
Código W5 en NBR termina W5N
Código W5 en FKM termina W5F

(1) acoplamiento con anillo interior en acero inoxidable incorporado.

Junta: EPDM: -20°C hasta +100°C NBR: -20°C hasta +80°C FKM: -20°C hasta +180°C

Fluido: EPDM: Todas las calidades de agua, aguas residuales, aire, sólidos y diversos productos químicos.

NBR: Agua, gas, aceite, combustible y otros hidrocarburos.

FKM: Ozono, oxígeno, ácidos, gas, aceite y carburantes.

Especificar 1 o 2 cierres

OPEN FLEX 2 PN 6

J1

desde Ø exterior	hasta Ø exterior	Ref. EPDM	W1 CARCASA GALVANIZADA. CIERRES GALVANIZADOS			W2 CARCASA EN ACERO INOX. CIERRES GALVANIZADOS			W5 CARCASA EN ACERO INOX. CIERRES EN ACERO INOX.		
			€ EPDM	€ NBR	€ FKM (1)	€ EPDM	€ NBR	€ FKM (1)	€ EPDM	€ NBR	€ FKM (1)
172,0	199,0					513,92	513,92	688,91	584,80	584,80	759,79
200,0	224,0					531,64	531,64	735,43	602,52	602,52	806,31
225,0	249,0					542,71	542,71	781,94	613,59	613,59	852,83
250,0	274,0					558,20	558,20	830,70	629,09	629,09	901,53
275,0	299,0	OF2060275W1E	1.072,11	1.072,11	1.351,22	571,53	571,53	881,62	642,41	642,41	952,50
300,0	324,0	OF2060300W1E	1.089,82	1.089,82	1.408,84	589,24	589,24	928,15	660,11	660,11	999,02
325,0	349,0	OF2060325W1E	1.109,78	1.109,78	1.466,39	600,27	600,27	976,86	671,18	671,18	1.047,74
350,0	374,0	OF2060350W1E	1.127,48	1.127,48	1.519,58	618,02	618,02	1.030,04	688,93	688,93	1.100,91
375,0	399,0	OF2060375W1E	1.147,44	1.147,44	1.581,60	629,09	629,09	1.074,34	699,96	699,96	1.145,22
400,0	424,0	OF2060400W1E	1.165,13	1.165,13	1.639,21	640,17	640,17	1.123,05	711,05	711,05	1.193,93
425,0	449,0	OF2060425W1E	1.187,32	1.187,32	1.690,15	664,55	664,55	1.176,24	735,42	735,42	1.247,13
450,0	474,0	OF2060450W1E	1.205,01	1.205,01	1.743,32	677,85	677,85	1.222,75	748,72	748,72	1.293,63
475,0	499,0	OF2060475W1E	1.222,75	1.222,75	1.794,25	697,78	697,78	1.273,69	768,66	768,66	1.344,57
500,0	524,0	OF2060500W1E	1.240,45	1.240,45	1.847,42	715,50	715,50	1.322,43	786,38	786,38	1.393,32
525,0	549,0	OF2060525W1E	1.267,07	1.267,07	1.905,00	795,23	795,23	1.444,26	866,11	866,11	1.515,15
550,0	574,0	OF2060550W1E	1.302,50	1.302,50	1.978,12	815,19	815,19	1.495,19	886,06	886,06	1.566,08
575,0	599,0	OF2060575W1E	1.329,09	1.329,09	2.037,91	835,11	835,11	1.543,95	906,01	906,01	1.614,84
600,0	624,0	OF2060600W1E	1.408,84	1.408,84	2.115,46	1.118,62	1.118,62	1.825,27	1.193,93	1.193,93	1.900,55
625,0	649,0	OF2060625W1E	1.435,40	1.435,40	2.184,13	1.149,66	1.149,66	1.898,38	1.224,97	1.224,97	1.973,67
650,0	674,0	OF2060650W1E	1.466,39	1.466,39	2.248,35	1.176,24	1.176,24	1.958,18	1.251,55	1.251,55	2.033,49
675,0	699,0	OF2060675W1E	1.495,19	1.495,19	2.303,76	1.211,69	1.211,69	2.022,41	1.287,00	1.287,00	2.097,71
700,0	724,0	OF2060700W1E	1.526,24	1.526,24	2.367,97	1.236,02	1.236,02	2.077,81	1.311,35	1.311,35	2.153,13
725,0	749,0	OF2060725W1E	1.555,04	1.555,04	2.427,77	1.271,49	1.271,49	2.142,02	1.346,81	1.346,81	2.217,35
750,0	799,0	OF2060750W1E	1.579,38	1.579,38	2.463,23	1.504,06	1.504,06	2.279,38	1.579,38	1.579,38	2.354,70
800,0	849,0	OF2060800W1E	1.643,62	1.643,62	2.536,33	1.557,22	1.557,22	2.401,20	1.632,54	1.632,54	2.476,51

Acoplamiento abierto para tubos de cualquier material sin anclaje axial.
Abierto con bisagra.

Código W1 en NBR termina W1N
Código W1 en FKM termina W1F

Código W2 en EPDM termina W2E
Código W2 en NBR termina W2N
Código W2 en FKM termina W2F

Código W5 en EPDM termina W5E
Código W5 en NBR termina W5N
Código W5 en FKM termina W5F

Continúa en la página siguiente...

J1

desde Ø exterior	hasta Ø exterior	Ref. EPDM	W1 CARCASA GALVANIZADA. CIERRES GALVANIZADOS			W2 CARCASA EN ACERO INOX. CIERRES GALVANIZADOS			W5 CARCASA EN ACERO INOX. CIERRES EN ACERO INOX.		
			€ EPDM	€ NBR	€ FKM (1)	€ EPDM	€ NBR	€ FKM (1)	€ EPDM	€ NBR	€ FKM (1)
850,0	899,0	OF2060850W1E	1.701,23	1.701,23	2.607,20	1.612,60	1.612,60	2.518,61	1.687,92	1.687,92	2.593,91
900,0	949,0	OF2060900W1E	1.758,79	1.758,79	2.726,84	1.672,44	1.672,44	2.640,41	1.747,74	1.747,74	2.715,74
950,0	999,0	OF2060950W1E	1.818,62	1.818,62	2.853,10	1.727,80	1.727,80	2.760,06	1.803,11	1.803,11	2.835,38
1.000,0	1.049,0	OF2061000W1E	1.876,21	1.876,21	2.970,48	1.783,16	1.783,16	2.879,67	1.858,48	1.858,48	2.954,97
1.050,0	1.099,0	OF2061050W1E	1.942,67	1.942,67	3.087,89	1.858,48	1.858,48	3.005,92	1.933,80	1.933,80	3.081,23
1.100,0	1.149,0	OF2061100W1E	1.993,60	1.993,60	3.185,34	1.942,67	1.942,67	3.132,20	2.017,97	2.017,97	3.207,51
1.150,0	1.199,0	OF2061150W1E	2.053,43	2.053,43	3.293,88	2.020,20	2.020,20	3.260,65	2.095,52	2.095,52	3.335,98
1.200,0	1.249,0	OF2061200W1E	2.113,24	2.113,24	3.404,67				2.904,64	2.904,64	5.297,09
1.250,0	1.299,0	OF2061250W1E	2.173,04	2.173,04	3.513,21				2.974,92	2.974,92	5.452,77
1.300,0	1.349,0	OF2061300W1E	2.230,63	2.230,63	3.623,94				3.045,19	3.045,19	5.608,42
1.350,0	1.399,0	OF2061350W1E	2.290,43	2.290,43	3.732,49				3.118,00	3.118,00	5.766,57
1.400,0	1.449,0	OF2061400W1E	2.350,26	2.350,26	3.845,47				3.193,32	3.193,32	5.924,74
1.450,0	1.499,0	OF2061450W1E	2.410,08	2.410,08	3.954,01				3.271,14	3.271,14	6.085,41
1.500,0	1.549,0	OF2061500W1E	2.467,65	2.467,65	4.062,56				3.348,99	3.348,99	6.251,09
1.550,0	1.600,0	OF2061550W1E	2.527,46	2.527,46	4.173,28				3.429,30	3.429,30	6.411,75
1.600,0	1.649,0	OF2061600W1E	2.587,26	2.587,26	4.281,83				3.512,16	3.512,16	6.579,97
1.650,0	1.699,0	OF2061650W1E	2.647,10	2.647,10	4.392,60				3.597,53	3.597,53	6.750,67
1.700,0	1.749,0	OF2061700W1E	2.706,88	2.706,88	4.501,15				3.896,26	3.896,26	7.134,77
1.750,0	1.799,0	OF2061750W1E	2.764,48	2.764,48	4.611,89				3.994,16	3.994,16	7.315,53
1.800,0	1.849,0	OF2061800W1E	2.824,29	2.824,29	4.720,44				4.092,08	4.092,08	7.498,81
1.850,0	1.899,0	OF2061850W1E	2.884,09	2.884,09	4.831,21				4.197,50	4.197,50	7.684,55
1.900,0	1.949,0	OF2061900W1E	3.761,29	3.761,29	5.759,31				4.300,44	4.300,44	7.875,39
1.950,0	1.999,0	OF2061950W1E	3.836,62	3.836,62	5.883,38				4.408,38	4.408,38	8.068,65
2.000,0	2.032,0	OF2062000W1E	3.911,92	3.911,92	6.009,64				4.518,86	4.518,86	8.261,99

Código W1 en NBR termina W1N
Código W1 en FKM termina W1F

Código W2 en EPDM termina W2E
Código W2 en NBR termina W2N
Código W2 en FKM termina W2F

Código W5 en EPDM termina W5E
Código W5 en NBR termina W5N
Código W5 en FKM termina W5F

(1) acoplamiento con anillo interior en acero inoxidable incorporado.

Junta: EPDM: -20°C hasta +100°C NBR: -20°C hasta +80°C FKM: -20°C hasta +180°C

Fluido: EPDM: Todas las calidades de agua, aguas residuales, aire, sólidos y diversos productos químicos.

NBR: Agua, gas, aceite, combustible y otros hidrocarburos.

FKM: Ozono, oxígeno, ácidos, gas, aceite y carburantes.

Especificar 1 o 2 cierres

OPEN FLEX 2 PN 10

J1

desde Ø exterior	hasta Ø exterior	Ref. EPDM	W1 CARCASA GALVANIZADA. CIERRES GALVANIZADOS			W2 CARCASA EN ACERO INOX. CIERRES GALVANIZADOS			W5 CARCASA EN ACERO INOX. CIERRES EN ACERO INOX.		
			€ EPDM	€ NBR	€ FKM (1)	€ EPDM	€ NBR	€ FKM (1)	€ EPDM	€ NBR	€ FKM (1)
172,0	199,0					513,92	513,92	688,91	584,80	584,80	759,79
200,0	224,0					531,64	531,64	735,43	602,52	602,52	806,31
225,0	249,0					542,71	542,71	781,94	613,59	613,59	852,83
250,0	274,0					558,20	558,20	830,70	629,09	629,09	901,53
275,0	299,0	OF2100275W1E	1.072,11	1.072,11	1.351,22	615,80	615,80	934,76	686,68	686,68	1.005,67
300,0	324,0	OF2100300W1E	1.089,82	1.089,82	1.408,84	635,74	635,74	990,17	706,63	706,63	1.061,06
325,0	349,0	OF2100325W1E	1.109,78	1.109,78	1.466,39	649,03	649,03	1.036,69	719,91	719,91	1.107,57
350,0	374,0	OF2100350W1E	1.127,48	1.127,48	1.519,58	835,11	835,11	1.227,18	910,42	910,42	1.302,50
375,0	399,0	OF2100375W1E	1.147,44	1.147,44	1.581,60	850,61	850,61	1.284,78	925,91	925,91	1.360,09
400,0	424,0	OF2100400W1E	1.165,13	1.165,13	1.639,21	866,11	866,11	1.340,13	941,43	941,43	1.415,45
425,0	449,0	OF2100425W1E	1.187,32	1.187,32	1.690,15	894,93	894,93	1.397,75	970,23	970,23	1.473,08
450,0	474,0	OF2100450W1E	1.205,01	1.205,01	1.743,32	914,87	914,87	1.453,12	990,17	990,17	1.528,43
475,0	499,0	OF2100475W1E	1.222,75	1.222,75	1.794,25	943,66	943,66	1.515,15	1.018,96	1.018,96	1.590,47
500,0	524,0	OF2100500W1E	1.240,45	1.240,45	1.847,42	968,02	968,02	1.574,95	1.043,32	1.043,32	1.650,26
525,0	549,0	OF2100525W1E	1.267,07	1.267,07	1.905,00	996,80	996,80	1.636,96	1.072,11	1.072,11	1.712,29
550,0	574,0	OF2100550W1E	1.302,50	1.302,50	1.978,12	1.021,18	1.021,18	1.696,80	1.096,48	1.096,48	1.772,12
575,0	599,0	OF2100575W1E	1.329,09	1.329,09	2.037,91	1.045,55	1.045,55	1.752,18	1.120,88	1.120,88	1.827,48
600,0	624,0	OF2100600W1E	1.408,84	1.408,84	2.115,46	1.118,62	1.118,62	1.825,27	1.193,93	1.193,93	1.900,55
625,0	649,0	OF2100625W1E	1.435,40	1.435,40	2.184,13	1.149,66	1.149,66	1.898,38	1.224,97	1.224,97	1.973,67
650,0	674,0	OF2100650W1E	1.466,39	1.466,39	2.248,35	1.176,24	1.176,24	1.958,18	1.251,55	1.251,55	2.033,49
675,0	699,0	OF2100675W1E	1.495,19	1.495,19	2.303,76	1.211,69	1.211,69	2.022,41	1.287,00	1.287,00	2.097,71
700,0	724,0	OF2100700W1E	1.526,24	1.526,24	2.367,97	1.236,02	1.236,02	2.077,81	1.311,35	1.311,35	2.153,13
725,0	749,0	OF2100725W1E	1.555,04	1.555,04	2.427,77				2.430,16	2.430,16	3.981,62
750,0	799,0	OF2100750W1E	1.579,38	1.579,38	2.463,23				2.470,29	2.470,29	4.104,63
800,0	849,0	OF2100800W1E	1.643,62	1.643,62	2.536,33				2.507,97	2.507,97	4.227,63

Acoplamiento abierto para tubos de cualquier material sin anclaje axial.

Abierto con bisagra.

Código W1 en NBR termina W1N
Código W1 en FKM termina W1F

Código W2 en EPDM termina W2E
Código W2 en NBR termina W2N
Código W2 en FKM termina W2F

Código W5 en EPDM termina W5E
Código W5 en NBR termina W5N
Código W5 en FKM termina W5F

Continúa en la página siguiente...

J1

desde Ø exterior	hasta Ø exterior	Ref. EPDM	W1 CARCASA GALVANIZADA. CIERRES GALVANIZADOS			W2 CARCASA EN ACERO INOX. CIERRES GALVANIZADOS			W5 CARCASA EN ACERO INOX. CIERRES EN ACERO INOX.		
			€ EPDM	€ NBR	€ FKM (1)	€ EPDM	€ NBR	€ FKM (1)	€ EPDM	€ NBR	€ FKM (1)
850,0	899,0	OF2100850W1E	1.701,23	1.701,23	2.607,20				2.538,09	2.538,09	4.343,15
900,0	949,0	OF2100900W1E	1.758,79	1.758,79	2.726,84				2.590,82	2.590,82	4.478,70
950,0	999,0	OF2100950W1E	1.818,62	1.818,62	2.853,10				2.625,98	2.625,98	4.599,21
1.000,0	1.049,0	OF2101000W1E	2.405,63	2.405,63	3.499,89				2.661,10	2.661,10	4.719,71
1.050,0	1.099,0	OF2101050W1E	2.489,80	2.489,80	3.635,03				2.696,24	2.696,24	4.837,69
1.100,0	1.149,0	OF2101100W1E	2.558,44	2.558,44	3.748,00				2.769,07	2.769,07	4.995,84
1.150,0	1.199,0	OF2101150W1E	2.633,77	2.633,77	3.874,27				2.841,85	2.841,85	5.154,00
1.200,0	1.249,0	OF2101200W1E	2.709,08	2.709,08	4.000,52						
1.250,0	1.299,0	OF2101250W1E	2.784,39	2.784,39	4.124,58						
1.300,0	1.349,0	OF2101300W1E	2.859,71	2.859,71	4.250,83						
1.350,0	1.399,0	OF2101350W1E	2.935,03	2.935,03	4.377,09						
1.400,0	1.449,0	OF2101400W1E	3.010,34	3.010,34	4.503,36						
1.450,0	1.499,0	OF2101450W1E	3.085,66	3.085,66	4.629,62						
1.500,0	1.549,0	OF2101500W1E	3.160,98	3.160,98	4.755,90						
1.550,0	1.600,0	OF2101550W1E	3.236,29	3.236,29	4.879,91						
1.600,0	1.649,0	OF2101600W1E	3.311,61	3.311,61	5.006,17						
1.650,0	1.699,0	OF2101650W1E	3.386,91	3.386,91	5.130,24						
1.700,0	1.749,0	OF2101700W1E	3.462,24	3.462,24	5.256,48						
1.750,0	1.799,0	OF2101750W1E	3.537,56	3.537,56	5.382,74						
1.800,0	1.849,0	OF2101800W1E	3.610,67	3.610,67	5.506,80						
1.850,0	1.899,0	OF2101850W1E	3.685,97	3.685,97	5.633,06						
1.900,0	1.949,0	OF2101900W1E	3.761,29	3.761,29	5.759,31						
1.950,0	1.999,0	OF2101950W1E	3.836,62	3.836,62	5.883,38						
2.000,0	2.032,0	OF2102000W1E	3.911,92	3.911,92	6.009,64						

Código W1 en NBR termina W1N
 Código W1 en FKM termina W1F

Código W5 en EPDM termina W5E
 Código W5 en NBR termina W5N
 Código W5 en FKM termina W5F

(1) acoplamiento con anillo interior en acero inoxidable incorporado.

Junta: EPDM: -20°C hasta +100°C NBR: -20°C hasta +80°C FKM: -20°C hasta +180°C

Fluido: EPDM: Todas las calidades de agua, aguas residuales, aire, sólidos y diversos productos químicos.

NBR: Agua, gas, aceite, combustible y otros hidrocarburos.

FKM: Ozono, oxígeno, ácidos, gas, aceite y carburantes.

Especificar 1 o 2 cierres

OPEN FLEX 2 PN 16

J1

desde Ø exterior	hasta Ø exterior	Ref. EPDM	W1 CARCASA GALVANIZADA. CIERRES GALVANIZADOS			W2 CARCASA EN ACERO INOX. CIERRES GALVANIZADOS			W5 CARCASA EN ACERO INOX. CIERRES EN ACERO INOX.		
			€ EPDM	€ NBR	€ FKM (1)	€ EPDM	€ NBR	€ FKM (1)	€ EPDM	€ NBR	€ FKM (1)
180,0	199,0					553,76	553,76	742,06	624,66	624,66	812,94
200,0	224,0					573,71	573,71	786,37	644,60	644,60	857,25
225,0	249,0					733,21	733,21	934,77	808,52	808,52	1.010,09
250,0	274,0					753,15	753,15	992,37	828,46	828,46	1.067,68
275,0	299,0	OF2160275W1E	1.072,11	1.072,11	1.351,22	768,66	768,66	1.047,74	843,97	843,97	1.123,05
300,0	324,0	OF2160300W1E	1.089,82	1.089,82	1.408,84	793,04	793,04	1.112,00	868,36	868,36	1.187,32
325,0	349,0	OF2160325W1E	1.109,78	1.109,78	1.466,39	810,74	810,74	1.167,37	886,06	886,06	1.242,68
350,0	374,0	OF2160350W1E	1.127,48	1.127,48	1.519,58	835,11	835,11	1.227,18	910,42	910,42	1.302,50
375,0	399,0	OF2160375W1E	1.147,44	1.147,44	1.581,60	850,61	850,61	1.284,78	925,91	925,91	1.360,09
400,0	424,0	OF2160400W1E	1.165,13	1.165,13	1.639,21	866,11	866,11	1.340,13	941,43	941,43	1.415,45
425,0	449,0	OF2160425W1E	1.187,32	1.187,32	1.690,15				2.219,27	2.219,27	3.266,14
450,0	474,0	OF2160450W1E	1.205,01	1.205,01	1.743,32				2.236,84	2.236,84	3.323,88
475,0	499,0	OF2160475W1E	1.222,75	1.222,75	1.794,25				2.249,40	2.249,40	3.379,11
500,0	524,0	OF2160500W1E	1.240,45	1.240,45	1.847,42				2.266,95	2.266,95	3.439,36
525,0	549,0	OF2160525W1E	1.267,07	1.267,07	1.905,00				2.282,03	2.282,03	3.497,09
550,0	574,0	OF2160550W1E	1.302,50	1.302,50	1.978,12				2.299,58	2.299,58	3.554,83
575,0	599,0	OF2160575W1E	1.329,09	1.329,09	2.037,91				2.314,65	2.314,65	3.612,59
600,0	624,0	OF2160600W1E	1.408,84	1.408,84	2.115,46				2.342,27	2.342,27	3.682,88
625,0	649,0	OF2160625W1E	1.840,78	1.840,78	2.589,49				2.357,34	2.357,34	3.740,63
650,0	674,0	OF2160650W1E	1.882,86	1.882,86	2.662,59				2.374,91	2.374,91	3.798,34
675,0	699,0	OF2160675W1E	1.916,10	1.916,10	2.726,84				2.389,96	2.389,96	3.858,59
700,0	724,0	OF2160700W1E	1.955,94	1.955,94	2.797,73				2.405,04	2.405,04	3.913,84
725,0	749,0	OF2160725W1E	1.993,60	1.993,60	2.866,36				2.430,16	2.430,16	3.981,62
750,0	799,0	OF2160750W1E	2.024,63	2.024,63	2.910,68				2.470,29	2.470,29	4.104,63
800,0	849,0	OF2160800W1E	2.108,81	2.108,81	2.999,29				2.507,97	2.507,97	4.227,63
850,0	899,0	OF2160850W1E	2.184,13	2.184,13	3.090,12						
900,0	949,0	OF2160900W1E	2.257,20	2.257,20	3.223,00						
950,0	999,0	OF2160950W1E	2.332,51	2.332,51	3.364,76						
1.000,0	1.049,0	OF2161000W1E	2.405,63	2.405,63	3.499,89						
1.050,0	1.099,0	OF2161050W1E	2.489,80	2.489,80	3.635,03						
1.100,0	1.149,0	OF2161100W1E	2.558,44	2.558,44	3.748,00						
1.150,0	1.199,0	OF2161150W1E	2.633,77	2.633,77	3.874,27						
1.200,0	1.249,0	OF2161200W1E	2.709,08	2.709,08	4.000,52						
1.250,0	1.299,0	OF2161250W1E	2.784,39	2.784,39	4.124,58						
1.300,0	1.349,0	OF2161300W1E	2.859,71	2.859,71	4.250,83						
1.350,0	1.399,0	OF2161350W1E	2.935,03	2.935,03	4.377,09						
1.400,0	1.449,0	OF2161400W1E	3.010,34	3.010,34	4.503,36						
1.450,0	1.499,0	OF2161450W1E	3.085,66	3.085,66	4.629,62						

Acoplamiento abierto para tubos de cualquier material sin anclaje axial.

Abierto con bisagra.

Código W1 en NBR termina W1N
Código W1 en FKM termina W1F

Código W2 en EPDM termina W2E
Código W2 en NBR termina W2N
Código W2 en FKM termina W2F

Código W5 en EPDM termina W5E
Código W5 en NBR termina W5N
Código W5 en FKM termina W5F

(1) acoplamiento con anillo interior en acero inoxidable incorporado.

Junta: EPDM: -20°C hasta +100°C **NBR:** -20°C hasta +80°C **FKM:** -20°C hasta +180°C

Fluido: EPDM: Todas las calidades de agua, aguas residuales, aire, sólidos y diversos productos químicos.

NBR: Agua, gas, aceite, combustible y otros hidrocarburos.

FKM: Ozono, oxígeno, ácidos, gas, aceite y carburantes.

Especificar 1 o 2 cierres



OPEN FLEX 2 PN 20

J1

desde Ø exterior	hasta Ø exterior	Ref. EPDM	W1 CARCASA GALVANIZADA. CIERRES GALVANIZADOS			W2 CARCASA EN ACERO INOX. CIERRES GALVANIZADOS			W5 CARCASA EN ACERO INOX. CIERRES EN ACERO INOX.		
			€ EPDM	€ NBR	€ FKM (1)	€ EPDM	€ NBR	€ FKM (1)	€ EPDM	€ NBR	€ FKM (1)
180,0	199,0					699,97	699,97	835,11	775,29	775,29	910,42
200,0	224,0					715,49	715,49	881,63	790,80	790,80	956,94
225,0	249,0					733,21	733,20	934,77	808,52	808,52	1.010,09
250,0	274,0					753,15	753,15	992,37	828,46	828,46	1.067,68
275,0	299,0	OF2200275W1E	1.072,11	1.072,11	1.351,22	768,66	768,66	1.047,74	843,97	843,97	1.123,05
300,0	324,0	OF2200300W1E	1.089,82	1.089,82	1.408,84	793,04	793,04	1.112,00	868,36	868,36	1.187,32
325,0	349,0	OF2200325W1E	1.109,78	1.109,78	1.466,39				2.151,48	2.151,48	3.027,64
350,0	374,0	OF2200350W1E	1.127,48	1.127,48	1.519,58				2.164,02	2.164,02	3.085,39
375,0	399,0	OF2200375W1E	1.147,44	1.147,44	1.581,60				2.186,63	2.186,63	3.150,64
400,0	424,0	OF2200400W1E	1.165,13	1.165,13	1.639,21				2.204,22	2.204,22	3.205,90
425,0	449,0	OF2200425W1E	1.187,32	1.187,32	1.690,15				2.219,27	2.219,27	3.266,14
450,0	474,0	OF2200450W1E	1.205,01	1.205,01	1.743,32				2.236,84	2.236,84	3.323,88
475,0	499,0	OF2200475W1E	1.568,31	1.568,31	2.137,60				2.249,40	2.249,40	3.379,11
500,0	524,0	OF2200500W1E	1.590,47	1.590,47	2.197,39				2.266,95	2.266,95	3.439,36
525,0	549,0	OF2200525W1E	1.621,47	1.621,47	2.261,66				2.282,03	2.282,03	3.497,09
550,0	574,0	OF2200550W1E	1.670,21	1.670,21	2.345,83				2.299,58	2.299,58	3.554,83
575,0	599,0	OF2200575W1E	1.703,43	1.703,43	2.412,29				2.314,65	2.314,65	3.612,59
600,0	624,0	OF2200600W1E	1.805,33	1.805,33	2.511,95				2.342,27	2.342,27	3.682,88
625,0	649,0	OF2200625W1E	1.840,78	1.840,78	2.589,49				2.357,34	2.357,34	3.740,63
650,0	674,0	OF2200650W1E	1.882,86	1.882,86	2.662,59						
675,0	699,0	OF2200675W1E	1.916,10	1.916,10	2.726,84						
700,0	724,0	OF2200700W1E	1.955,94	1.955,94	2.797,73						
725,0	749,0	OF2200725W1E	1.993,60	1.993,60	2.866,36						
750,0	799,0	OF2200750W1E	2.024,63	2.024,63	2.910,68						
800,0	849,0	OF2200800W1E	2.108,81	2.108,81	2.999,29						
850,0	899,0	OF2200850W1E	2.184,13	2.184,13	3.090,12						
900,0	949,0	OF2200900W1E	2.257,20	2.257,20	3.223,00						
950,0	999,0	OF2200950W1E	2.332,51	2.332,51	3.364,76						

Acoplamiento abierto para tubos de cualquier material sin anclaje axial.

Abierto con bisagra.

Código W1 en NBR termina W1N
Código W1 en FKM termina W1F

Código W2 en EPDM termina W2E
Código W2 en NBR termina W2N
Código W2 en FKM termina W2F

Código W5 en EPDM termina W5E
Código W5 en NBR termina W5N
Código W5 en FKM termina W5F

(1) acoplamiento con anillo interior en acero inoxidable incorporado.

Junta: EPDM: -20°C hasta +100°C NBR: -20°C hasta +80°C FKM: -20°C hasta +180°C

Fluido: EPDM: Todas las calidades de agua, aguas residuales, aire, sólidos y diversos productos químicos.

NBR: Agua, gas, aceite, combustible y otros hidrocarburos.

FKM: Ozono, oxígeno, ácidos, gas, aceite y carburantes.

Especificar 1 o 2 cierres

OPEN FLEX 2 PN 25

J1

desde Ø exterior	hasta Ø exterior	Ref. EPDM	W1 CARCASA GALVANIZADA. CIERRES GALVANIZADOS			W2 CARCASA EN ACERO INOX. CIERRES GALVANIZADOS			W5 CARCASA EN ACERO INOX. CIERRES EN ACERO INOX.		
			€ EPDM	€ NBR	€ FKM (1)	€ EPDM	€ NBR	€ FKM (1)	€ EPDM	€ NBR	€ FKM (1)
180,0	199,0					699,97	699,97	835,11	775,29	775,29	910,42
200,0	224,0					715,49	715,49	881,63	790,80	790,80	956,94
225,0	249,0					733,21	733,20	934,77	808,52	808,52	1.010,09
250,0	274,0					753,15	753,15	992,37	828,46	828,46	1.067,68
275,0	299,0	OF2250275W1E	992,70	1.072,11	1.351,22				2.118,83	2.118,83	2.912,16
300,0	324,0	OF2250300W1E	1.089,82	1.089,82	1.408,84				2.133,90	2.133,90	2.967,37
325,0	349,0	OF2250325W1E	1.109,78	1.109,78	1.466,39				2.151,48	2.151,48	3.027,64
350,0	374,0	OF2250350W1E	1.444,26	1.444,26	1.836,33				2.164,02	2.164,02	3.085,39
375,0	399,0	OF2250375W1E	1.470,86	1.470,86	1.905,00				2.186,63	2.186,63	3.150,64
400,0	424,0	OF2250400W1E	1.495,19	1.495,19	1.967,04				2.204,22	2.204,22	3.205,90
425,0	449,0	OF2250425W1E	1.521,81	1.521,81	2.026,83				2.219,27	2.219,27	3.266,14
450,0	474,0	OF2250450W1E	1.543,95	1.543,95	2.082,24				2.236,84	2.236,84	3.323,88
475,0	499,0	OF2250475W1E	1.568,31	1.568,31	2.137,60				2.249,40	2.249,40	3.379,11
500,0	524,0	OF2250500W1E	1.590,47	1.590,47	2.197,39				2.266,95	2.266,95	3.439,36
525,0	549,0	OF2250525W1E	1.621,47	1.621,47	2.261,66						
550,0	574,0	OF2250550W1E	1.670,21	1.670,21	2.345,83						
575,0	599,0	OF2250575W1E	1.703,43	1.703,43	2.412,29						
600,0	624,0	OF2250600W1E	1.805,33	1.805,33	2.511,95						
625,0	649,0	OF2250625W1E	1.840,78	1.840,78	2.589,49						
650,0	674,0	OF2250650W1E	1.882,86	1.882,86	2.662,59						
675,0	699,0	OF2250675W1E	1.916,10	1.916,10	2.726,84						
700,0	724,0	OF2250700W1E	1.955,94	1.955,94	2.797,73						
725,0	749,0	OF2250725W1E	1.993,60	1.993,60	2.866,36						

Acoplamiento abierto para tubos de cualquier material sin anclaje axial.

Abierto con bisagra.

Código W1 en NBR termina W1N
Código W1 en FKM termina W1F

Código W2 en EPDM termina W2E
Código W2 en NBR termina W2N
Código W2 en FKM termina W2F

Código W5 en EPDM termina W5E
Código W5 en NBR termina W5N
Código W5 en FKM termina W5F

(1) acoplamiento con anillo interior en acero inoxidable incorporado.

Junta: EPDM: -20°C hasta +100°C NBR: -20°C hasta +80°C FKM: -20°C hasta +180°C

Fluido: EPDM: Todas las calidades de agua, aguas residuales, aire, sólidos y diversos productos químicos.

NBR: Agua, gas, aceite, combustible y otros hidrocarburos.

FKM: Ozono, oxígeno, ácidos, gas, aceite y carburantes.

Especificar 1 o 2 cierres



J1

OPEN FLEX 3 PN 2,5

desde Ø exterior	hasta Ø exterior	Ref. EPDM	W1 CARCASA GALVANIZADA. CIERRES GALVANIZADOS		W2 CARCASA EN ACERO INOX. CIERRES GALVANIZADOS		W5 CARCASA EN ACERO INOX. CIERRES EN ACERO INOX.	
			€ EPDM	€ NBR	€ EPDM	€ NBR	€ EPDM	€ NBR
219,1	249,0				1.408,83	1.789,83	1.577,16	1.958,17
250,0	299,0				1.464,20	1.858,47	1.632,55	2.026,84
300,0	349,0	OF3020300W1E	1.738,88	2.241,71	1.557,22	1.978,12	1.725,58	2.146,46
350,0	399,0	OF3020350W1E	1.803,11	2.325,89	1.652,49	2.097,71	1.820,83	2.266,10
400,0	449,0	OF3020400W1E	1.867,34	2.407,83	1.745,52	2.217,35	1.913,87	2.385,68
450,0	499,0	OF3020450W1E	1.929,38	2.489,80	1.838,55	2.336,97	2.006,92	2.505,31
500,0	549,0	OF3020500W1E	1.993,60	2.571,78	1.931,61	2.454,38	2.099,94	2.622,72
550,0	599,0	OF3020550W1E	2.057,86	2.655,95	2.026,83	2.573,98	2.195,20	2.742,32
600,0	649,0	OF3020600W1E	2.122,08	2.737,89	2.119,90	2.691,38	2.288,23	2.859,71
650,0	699,0	OF3020650W1E	2.188,55	2.822,05	2.208,49	2.804,35	2.376,82	2.972,68
700,0	749,0	OF3020700W1E	2.246,15	2.895,17	2.299,32	2.919,55	2.467,65	3.087,89
750,0	799,0	OF3020750W1E	2.312,59	2.983,77	2.396,77	3.043,58	2.565,11	3.211,94
800,0	849,0	OF3020800W1E	2.379,05	3.067,95	2.487,61	3.158,77	2.655,95	3.327,12
850,0	899,0	OF3020850W1E	2.452,14	3.165,44	2.578,40	3.273,94	2.746,74	3.442,33
900,0	949,0	OF3020900W1E	2.529,68	3.265,10	2.669,22	3.391,38	2.837,58	3.559,71
950,0	999,0	OF3020950W1E	2.604,99	3.360,34	2.762,27	3.508,77	2.930,60	3.677,11
1.000,0	1.049,0	OF3021000W1E	2.682,52	3.462,24	2.846,42	3.617,33	3.014,80	3.785,66
1.050,0	1.099,0	OF3021050W1E	2.762,27	3.564,14	2.943,92	3.736,92	3.112,24	3.905,27
1.100,0	1.149,0	OF3021100W1E	2.835,38	3.657,17	3.032,52	3.852,11	3.200,86	4.020,46
1.150,0	1.199,0	OF3021150W1E	2.899,60	3.741,34	3.125,55	3.969,50	3.293,88	4.137,87
1.200,0	1.249,0	OF3021200W1E	2.988,22	3.856,53	3.247,38	4.122,34	3.415,70	4.290,69
1.250,0	1.299,0	OF3021250W1E	3.083,45	3.976,15	3.367,01	4.277,42	3.535,34	4.445,76
1.300,0	1.349,0	OF3021300W1E	3.172,06	4.091,35	3.488,82	4.430,27	3.657,17	4.598,59
1.350,0	1.399,0	OF3021350W1E	3.265,10	4.210,93	3.608,44	4.583,08	3.776,79	4.751,46
1.400,0	1.449,0	OF3021400W1E	3.353,72	4.326,14	3.730,29	4.735,95	3.898,63	4.904,29
1.450,0	1.499,0	OF3021450W1E	3.442,33	4.441,32	3.852,11	4.890,99	4.020,46	5.059,35
1.500,0	1.549,0	OF3021500W1E	3.537,56	4.563,16	3.971,73	5.043,83	4.140,06	5.212,20
1.550,0	1.599,0	OF3021550W1E	3.623,94	4.673,92	4.093,55	5.196,70	4.261,92	5.365,04
1.600,0	1.649,0	OF3021600W1E	3.703,69	4.778,03	4.213,19	5.351,76	4.381,51	5.520,08
1.650,0	1.699,0	OF3021650W1E	3.785,66	4.882,15	4.335,00	5.504,61	4.503,36	5.672,95
1.700,0	1.749,0	OF3021700W1E	3.863,18	4.984,02	4.456,83	5.657,44	4.625,18	5.825,78
1.750,0	1.799,0	OF3021750W1E	3.958,42	5.105,86	4.576,48	5.812,49	4.744,80	5.980,83
1.800,0	1.849,0	OF3021800W1E	4.058,11	5.236,57	4.698,28	5.965,37	4.866,63	6.133,69
1.850,0	1.899,0	OF3021850W1E	4.160,00	5.367,25	4.817,90	6.118,19	4.986,26	6.286,53
1.900,0	1.949,0	OF3021900W1E	4.261,92	5.497,95	4.939,74	6.275,46	5.108,10	6.443,81
1.950,0	1.999,0	OF3021950W1E	4.366,01	5.633,06	5.061,58	6.428,29	5.229,91	6.596,67
2.000,0	2.032,0	OF3022000W1E	4.472,33	5.768,20	5.181,17	6.581,14	5.349,56	6.749,52

Acoplamiento abierto para tubos de cualquier material sin anclaje axial.

Abierto con bisagra.

Código W1 en NBR termina W1N

Código W2 en EPDM termina W2E

Código W2 en NBR termina W2N

Código W5 en EPDM termina W5E

Código W5 en NBR termina W5N

(1) acoplamiento con anillo interior en acero inoxidable incorporado.

Junta: EPDM: -20°C hasta +100°C NBR: -20°C hasta +80°C

Fluido: EPDM: Todas las calidades de agua, aguas residuales, aire, sólidos y diversos productos químicos.

NBR: Agua, gas, aceite, combustible y otros hidrocarburos.

Especificar 1 o 2 cierres



J1

OPEN FLEX 3 PN 6

desde Ø exterior	hasta Ø exterior	Ref. EPDM	W1 CARCASA GALVANIZADA. CIERRES GALVANIZADOS		W2 CARCASA EN ACERO INOX. CIERRES GALVANIZADOS		W5 CARCASA EN ACERO INOX. CIERRES EN ACERO INOX.	
			€ EPDM	€ NBR	€ EPDM	€ NBR	€ EPDM	€ NBR
219,1	249,0				1.408,83	1.789,83	1.577,16	1.958,17
250,0	299,0				1.464,20	1.858,47	1.632,55	2.026,84
300,0	349,0	OF3060300W1E	1.738,88	2.241,71	1.557,22	1.978,12	1.725,58	2.146,46
350,0	399,0	OF3060350W1E	1.803,11	2.325,89	1.652,49	2.097,71	1.820,83	2.266,10
400,0	449,0	OF3060400W1E	1.867,34	2.407,83	1.745,52	2.217,35	1.913,87	2.385,68
450,0	499,0	OF3060450W1E	1.929,38	2.489,80	1.838,55	2.336,97	2.006,92	2.505,31
500,0	549,0	OF3060500W1E	1.993,60	2.571,78	1.931,61	2.454,38	2.099,94	2.622,72
550,0	599,0	OF3060550W1E	2.057,86	2.655,95	2.026,83	2.573,98	2.195,20	2.742,32
600,0	649,0	OF3060600W1E	2.122,08	2.737,89	2.119,90	2.691,38	2.288,23	2.859,71
650,0	699,0	OF3060650W1E	2.188,55	2.822,05	2.208,49	2.804,35	2.376,82	2.972,68
700,0	749,0	OF3060700W1E	2.246,15	2.895,17	2.299,32	2.919,55	2.467,65	3.087,89
750,0	799,0	OF3060750W1E	2.312,59	2.983,77	2.396,77	3.043,58	2.565,11	3.211,94
800,0	849,0	OF3060800W1E	2.379,05	3.067,95	2.487,61	3.158,77	2.655,95	3.327,12
850,0	899,0	OF3060850W1E	2.452,14	3.165,44	2.578,40	3.273,94	2.746,74	3.442,33
900,0	949,0	OF3060900W1E	2.529,68	3.265,10	2.669,22	3.391,38	2.837,58	3.559,71
950,0	999,0	OF3060950W1E	2.604,99	3.360,34	2.762,27	3.508,77	2.930,60	3.677,11
1.000,0	1.049,0	OF3061000W1E	2.682,52	3.462,24			3.901,29	4.104,63
1.050,0	1.099,0	OF3061050W1E	2.762,27	3.564,14			3.964,03	4.174,92
1.100,0	1.149,0	OF3061100W1E	2.835,38	3.657,17			4.024,29	4.245,22
1.150,0	1.199,0	OF3061150W1E	2.899,60	3.741,34			4.102,12	4.330,57
1.200,0	1.249,0	OF3061200W1E	2.988,22	3.856,53			4.174,92	4.415,91
1.250,0	1.299,0	OF3061250W1E	3.083,45	3.976,15			4.232,66	4.481,20
1.300,0	1.349,0	OF3061300W1E	3.172,06	4.091,35			4.307,98	4.566,56
1.350,0	1.399,0	OF3061350W1E	3.265,10	4.210,93			4.383,30	4.651,91
1.400,0	1.449,0	OF3061400W1E	3.353,72	4.326,14			4.453,58	4.729,74
1.450,0	1.499,0	OF3061450W1E	3.442,33	4.441,32			4.551,50	4.835,18
1.500,0	1.549,0	OF3061500W1E	3.537,56	4.563,16			4.644,40	4.938,13
1.550,0	1.599,0	OF3061550W1E	3.623,94	4.673,92			4.717,19	5.018,44
1.600,0	1.649,0	OF3061600W1E	3.703,69	4.778,03			4.795,01	5.106,31
1.650,0	1.699,0	OF3061650W1E	3.785,66	4.882,15			4.887,91	5.209,26
1.700,0	1.749,0	OF3061700W1E	3.863,18	4.984,02			4.980,79	5.312,17
1.750,0	1.799,0	OF3061750W1E	3.958,42	5.105,86			5.073,67	5.415,10
1.800,0	1.849,0	OF3061800W1E	4.058,11	5.236,57			5.445,23	5.796,69
1.850,0	1.899,0	OF3061850W1E	4.160,00	5.367,25			5.513,00	5.872,02
1.900,0	1.949,0	OF3061900W1E	4.261,92	5.497,95			5.578,29	5.947,33
1.950,0	1.999,0	OF3061950W1E	4.366,01	5.633,06			5.663,64	6.040,22
2.000,0	2.032,0	OF3062000W1E	4.472,33	5.768,20			5.756,52	6.143,14

Acoplamiento abierto para tubos de cualquier material sin anclaje axial.
Abierto con bisagra.

Código W1 en NBR termina W1N

Código W2 en EPDM termina W2E
Código W2 en NBR termina W2N

Código W5 en EPDM termina W5E
Código W5 en NBR termina W5N

En caso de pedido indicar el diámetro exterior exacto

Junta: EPDM: -20°C hasta +100°C NBR: -20°C hasta +80°C

Fluido: EPDM: Todas las calidades de agua, aguas residuales, aire, sólidos y diversos productos químicos.

NBR: Agua, gas, aceite, combustible y otros hidrocarburos.

Especificación 1 o 2 cierres



J1

OPEN FLEX 3 PN 10

desde Ø exterior	hasta Ø exterior	Ref. EPDM	W1 CARCASA GALVANIZADA. CIERRES GALVANIZADOS		W2 CARCASA EN ACERO INOX. CIERRES GALVANIZADOS		W5 CARCASA EN ACERO INOX. CIERRES EN ACERO INOX.	
			€ EPDM	€ NBR	€ EPDM	€ NBR	€ EPDM	€ NBR
219,1	249,0				1.408,83	1.789,83	1.577,16	1.958,17
250,0	299,0				1.464,20	1.858,47	1.632,55	2.026,84
300,0	349,0	OF3100300W1E	1.738,88	2.241,71	1.557,22	1.978,12	1.725,58	2.146,46
350,0	399,0	OF3100350W1E	1.803,11	2.325,89	1.652,49	2.097,71	1.820,83	2.266,10
400,0	449,0	OF3100400W1E	1.867,34	2.407,83	1.745,52	2.217,35	1.913,87	2.385,68
450,0	499,0	OF3100450W1E	1.929,38	2.489,80	1.838,55	2.336,97	2.006,92	2.505,31
500,0	549,0	OF3100500W1E	1.993,60	2.571,78			3.070,33	3.175,76
525,0	549,0						3.118,00	3.228,49
550,0	599,0	OF3100550W1E	2.057,86	2.655,95			3.170,74	3.283,71
575,0	599,0						3.218,43	3.338,92
600,0	649,0	OF3100600W1E	2.122,08	2.737,89			3.291,25	3.421,77
650,0	699,0	OF3100650W1E	2.188,55	2.822,05			3.353,98	3.492,09
700,0	749,0	OF3100700W1E	2.246,15	2.895,17			3.414,23	3.559,86
750,0	799,0	OF3100750W1E	2.312,59	2.983,77			3.477,03	3.635,18
800,0	849,0	OF3100800W1E	2.379,05	3.067,95			3.542,27	3.707,97
850,0	899,0	OF3100850W1E	2.452,14	3.165,44			3.645,21	3.818,44
900,0	949,0	OF3100900W1E	2.529,68	3.265,10			3.745,63	3.933,91
950,0	999,0	OF3100950W1E	2.604,99	3.360,34			3.828,46	4.021,79
1.000,0	1.049,0	OF3101000W1E	2.682,52	3.462,24			3.901,29	4.104,63
1.050,0	1.099,0	OF3101050W1E	2.762,27	3.564,14			3.964,03	4.174,92
1.100,0	1.149,0	OF3101100W1E	2.835,38	3.657,17			4.024,29	4.245,22
1.150,0	1.199,0	OF3101150W1E	2.899,60	3.741,34			4.102,12	4.330,57
1.200,0	1.249,0	OF3101200W1E	2.988,22	3.856,53			4.174,92	4.415,91
1.250,0	1.299,0	OF3101250W1E	6.537,29	7.134,77			4.232,66	4.481,20
1.300,0	1.349,0	OF3101300W1E	6.632,69	7.240,20			4.307,98	4.566,56
1.350,0	1.399,0	OF3101350W1E	6.720,55	7.338,12			4.383,30	4.651,91
1.400,0	1.449,0	OF3101400W1E	6.815,95	7.446,08			4.453,58	4.729,74
1.450,0	1.499,0	OF3101450W1E	6.911,35	7.554,04			Consultar	Consultar
1.500,0	1.549,0	OF3101500W1E	7.001,73	7.654,44				
1.550,0	1.599,0	OF3101550W1E	7.094,61	7.759,88				
1.600,0	1.649,0	OF3101600W1E	7.185,00	7.860,31				
1.650,0	1.699,0	OF3101650W1E	7.280,40	7.965,75				
1.700,0	1.749,0	OF3101700W1E	7.370,76	8.068,65				
1.750,0	1.799,0	OF3101750W1E	7.466,15	8.174,10				
1.800,0	1.849,0	OF3101800W1E	7.554,04	8.274,55				
1.850,0	1.899,0	OF3101850W1E	7.649,44	8.380,00				
1.900,0	1.949,0	OF3101900W1E	7.739,81	8.480,41				
1.950,0	1.999,0	OF3101950W1E	7.835,18	8.588,34				
2.000,0	2.032,0	OF3102000W1E	7.923,07	8.686,25				

Acoplamiento abierto para tubos de cualquier material sin anclaje axial.
Abierto con bisagra.

Código W1 en NBR termina W1N

Código W2 en EPDM termina W2E
Código W2 en NBR termina W2NCódigo W5 en EPDM termina W5E
Código W5 en NBR termina W5N

En caso de pedido indicar el diámetro exterior exacto

Junta: EPDM: -20°C hasta +100°C NBR: -20°C hasta +80°C

Fluido: EPDM: Todas las calidades de agua, aguas residuales, aire, sólidos y diversos productos químicos.

NBR: Agua, gas, aceite, combustible y otros hidrocarburos.

Especificar 1 o 2 cierres

OPEN FLEX 3 PN 16

J1

desde Ø exterior	hasta Ø exterior	Ref. EPDM	W1 CARCASA GALVANIZADA. CIERRES GALVANIZADOS		W2 CARCASA EN ACERO INOX. CIERRES GALVANIZADOS		W5 CARCASA EN ACERO INOX. CIERRES EN ACERO INOX.	
			€ EPDM	€ NBR	€ EPDM	€ NBR	€ EPDM	€ NBR
219,1	249,0				1.408,83	1.789,83	1.577,16	1.958,17
250,0	299,0				1.464,20	1.858,47	1.632,55	2.026,84
300,0	349,0	OF3160300W1E	1.738,88	2.241,71	1.557,22	1.978,12	1.725,58	2.146,46
350,0	399,0	OF3160350W1E	1.803,11	2.325,89			2.766,53	2.844,38
375,0	399,0						2.821,79	2.904,64
400,0	449,0	OF3160400W1E	1.867,34	2.407,83			2.869,48	2.957,35
425,0	449,0						2.919,68	3.012,58
450,0	499,0	OF3160450W1E	1.929,38	2.489,80			2.969,88	3.067,80
475,0	499,0						3.020,10	3.120,51
500,0	549,0	OF3160500W1E	1.993,60	2.571,78			3.070,33	3.175,76
525,0	549,0						3.118,00	3.228,49
550,0	599,0	OF3160550W1E	2.057,86	2.655,95			3.170,74	3.283,71
575,0	599,0						3.218,43	3.338,92
600,0	649,0	OF3160600W1E	2.122,08	2.737,89			3.291,25	3.421,77
650,0	699,0	OF3160650W1E	2.188,55	2.822,05			3.353,98	3.492,09
700,0	749,0	OF3160700W1E	2.246,15	2.895,17			3.414,23	3.559,86
750,0	799,0	OF3160750W1E	5.297,09	5.781,65			3.477,03	3.635,18
800,0	849,0	OF3160800W1E	5.395,02	5.887,09			3.542,27	3.707,97
850,0	899,0	OF3160850W1E	5.485,38	5.987,48			Consultar	Consultar
900,0	949,0	OF3160900W1E	5.578,29	6.095,44				
950,0	999,0	OF3160950W1E	5.668,68	6.195,87				
1.000,0	1.049,0	OF3161000W1E	5.764,05	6.301,33				
1.050,0	1.099,0	OF3161050W1E	5.859,46	6.409,24				
1.100,0	1.149,0	OF3161100W1E	6.258,62	6.818,45				
1.150,0	1.199,0	OF3161150W1E	6.354,02	6.923,89				
1.200,0	1.249,0	OF3161200W1E	6.441,88	7.026,82				
1.250,0	1.299,0	OF3161250W1E	6.537,29	7.134,77				
1.300,0	1.349,0	OF3161300W1E	6.632,69	7.240,20				
1.350,0	1.399,0	OF3161350W1E	6.720,55	7.338,12				
1.400,0	1.449,0	OF3161400W1E	6.815,95	7.446,08				
1.450,0	1.499,0	OF3161450W1E	6.911,35	7.554,04				
1.500,0	1.549,0	OF3161500W1E	7.001,73	7.654,44				
1.550,0	1.599,0	OF3161550W1E	Consultar	Consultar				

Acoplamiento abierto para tubos de cualquier material sin anclaje axial.

Abierto con bisagra.

Código W1 en NBR termina W1N

Código W2 en EPDM termina W2E

Código W2 en NBR termina W2N

Código W5 en EPDM termina W5E

Código W5 en NBR termina W5N

En caso de pedido indicar el diámetro exterior exacto

Junta: EPDM: -20°C hasta +100°C NBR: -20°C hasta +80°C

Fluido: EPDM: Todas las calidades de agua, aguas residuales, aire, sólidos y diversos productos químicos.

NBR: Agua, gas, aceite, combustible y otros hidrocarburos.

Especificar 1 o 2 cierres

OPEN FLEX 3 PN 20

J1

W1 CARCASA GALVANIZADA. CIERRES GALVANIZADOS

W5 CARCASA EN ACERO INOX. CIERRES EN ACERO INOX.

desde Ø exterior	hasta Ø exterior	Ref. EPDM	€ EPDM	Ref. NBR	€ NBR	Ref. EPDM	€ EPDM	Ref. NBR	€ NBR
323,9	349,0	OF3200323W1E	1.738,88	OF3200323W1N	2.241,71	OF3200323W5E	2.716,34	OF3200323W5N	2.789,13
350,0	399,0	OF3200350W1E	1.803,11	OF3200350W1N	2.325,89	OF3200350W5E	2.766,53	OF3200350W5N	2.844,38
375,0	399,0					OF3200375W5E	2.821,79	OF3200375W5N	2.904,64
400,0	449,0	OF3200400W1E	1.867,34	OF3200400W1N	2.407,83	OF3200400W5E	2.869,48	OF3200400W5N	2.957,35
425,0	449,0					OF3200425W5E	2.919,68	OF3200425W5N	3.012,58
450,0	499,0	OF3200450W1E	1.929,38	OF3200450W1N	2.489,80	OF3200450W5E	2.969,88	OF3200450W5N	3.067,80
475,0	499,0					OF3200475W5E	3.020,10	OF3200475W5N	3.120,51
500,0	549,0	OF3200500W1E	1.993,60	OF3200500W1N	2.571,78	OF3200500W5E	3.070,33	OF3200500W5N	3.175,76
525,0	549,0					OF3200525W5E	3.118,00	OF3200525W5N	3.228,49
550,0	599,0	OF3200550W1E	4.978,28	OF3200550W1N	5.420,12	OF3200550W5E	3.170,74	OF3200550W5N	3.283,71
575,0	599,0					OF3200575W5E	3.218,43	OF3200575W5N	3.338,92
600,0	649,0	OF3200600W1E	5.025,97	OF3200600W1N	5.477,85	OF3200600W5E	3.291,25	OF3200600W5N	3.421,77
650,0	699,0	OF3200650W1E	5.113,85	OF3200650W1N	5.578,29	OF3200650W5E	Consultar	OF3200650W5N	Consultar
700,0	749,0	OF3200700W1E	5.209,26	OF3200700W1N	5.683,73				
750,0	799,0	OF3200750W1E	5.297,09	OF3200750W1N	5.781,65				
800,0	849,0	OF3200800W1E	5.395,02	OF3200800W1N	5.887,09				
850,0	899,0	OF3200850W1E	5.485,38	OF3200850W1N	5.987,48				
900,0	949,0	OF3200900W1E	5.578,29	OF3200900W1N	6.095,44				
950,0	999,0	OF3200950W1E	5.668,68	OF3200950W1N	6.195,87				
1.000,0	1.049,0	OF3201000W1E	5.764,05	OF3201000W1N	6.301,33				
1.050,0	1.099,0	OF3201050W1E	5.859,46	OF3201050W1N	6.409,24				
1.100,0	1.149,0	OF3201100W1E	6.258,62	OF3201100W1N	6.818,45				
1.150,0	1.199,0	OF3201150W1E	Consultar	OF3201150W1N	Consultar				

Acoplamiento abierto para tubos de cualquier material sin anclaje axial.
 Abierto con bisagra.

En caso de pedido indicar el diámetro exterior exacto.
 Junta: EPDM: -20°C hasta +100°C NBR: -20°C hasta +80°C
 Fluido: EPDM: Todas las calidades de agua, aguas residuales, aire, sólidos y diversos productos químicos.
 NBR: Agua, gas, aceite, combustible y otros hidrocarburos.
 Especificar 1 o 2 cierres

OPEN FLEX 3 PN 25

J1

W1 CARCASA GALVANIZADA. CIERRES GALVANIZADOS
W5 CARCASA EN ACERO INOX. CIERRES EN ACERO INOX.

desde Ø exterior	hasta Ø exterior	Ref. EPDM	€ EPDM	Ref. NBR	€ NBR	Ref. EPDM	€ EPDM	Ref. NBR	€ NBR
323,9	349,0	OF3250323W1E	1.738,88	OF3250323W1N	2.241,71	OF3250323W5E	2.716,34	OF3250323W5N	2.789,13
350,0	399,0	OF3250350W1E	1.803,11	OF3250350W1N	2.325,89	OF3250350W5E	2.766,53	OF3250350W5N	2.844,38
375,0	399,0					OF3250375W5E	2.821,79	OF3250375W5N	2.904,64
400,0	449,0	OF3250400W1E	1.867,34	OF3250400W1N	2.407,83	OF3250400W5E	2.869,48	OF3250400W5N	2.957,35
425,0	449,0					OF3250425W5E	2.919,68	OF3250425W5N	3.012,58
450,0	499,0	OF3250450W1E	1.929,38	OF3250450W1N	2.489,80	OF3250450W5E	2.969,88	OF3250450W5N	3.067,80
475,0	499,0					OF3250475W5E	3.020,10	OF3250475W5N	3.120,51
500,0	549,0	OF3250550W1E		OF3250550W1N		OF3250500W5E	Consultar	OF3250500W5N	Consultar
550,0	599,0	OF3250600W1E	4.978,28	OF3250600W1N	5.420,12				
600,0	649,0	OF3250650W1E	5.025,97	OF3250650W1N	5.477,85				
650,0	699,0	OF3250700W1E	5.113,85	OF3250700W1N	5.578,29				
700,0	749,0	OF3250750W1E	5.209,26	OF3250750W1N	5.683,73				
750,0	799,0	OF3250800W1E	5.297,09	OF3250800W1N	5.781,65				
800,0	849,0	OF3250850W1E	5.395,02	OF3250850W1N	5.887,09				
850,0	899,0	OF3250900W1E	5.485,38	OF3250900W1N	5.987,48				
900,0	949,0	OF3250950W1E	5.578,29	OF3250950W1N	6.095,44				
950,0	999,0	OF3201150W1E	Consultar	OF3201150W1N	Consultar				

Acoplamiento abierto para tubos de cualquier material sin anclaje axial.
 Abierto con bisagra.

En caso de pedido indicar el diámetro exterior exacto.
Junta: EPDM: -20°C hasta +100°C NBR: -20°C hasta +80°C
Fluido: EPDM: Todas las calidades de agua, aguas residuales, aire, sólidos y diversos productos químicos.
 NBR: Agua, gas, aceite, combustible y otros hidrocarburos.
 Especificar 1 o 2 cierres



J1

STEP FLEX 2

CARCASA GALVANIZADA / ACERO INOXIDABLE

Ø exterior tubo 1	Ø exterior tubo 2	Ref. EPDM	€ EPDM
219,1	230 - 250	STF2219E	Consultar
250,0	220 - 280	STF2250E	Consultar
267,0	237 - 297	STF2267E	Consultar
273,0	243 - 303	STF2273E	Consultar
304,0	274 - 334	STF2304E	Consultar
323,9	293 - 353	STF2323E	Consultar
355,6	325 - 385	STF2355E	Consultar
406,4	376 - 436	STF2406E	Consultar
457,2	427 - 487	STF2457E	Consultar
508,0	478 - 538	STF2508E	Consultar
558,8	528 - 588	STF2558E	Consultar
609,6	579 - 639	STF2609E	Consultar
711,2	681 - 741	STF2711E	Consultar
762,0	732 - 792	STF2762E	Consultar
812,8	782 - 842	STF2812E	Consultar

Acoplamiento para tubos de cualquier material sin anclaje axial.
Unión para tuberías de diferentes materiales y diámetros.

Junta: EPDM: -20°C hasta +100°C
Fluido: EPDM: Todas las calidades de agua, aguas residuales, aire, sólidos y diversos productos químicos.



J1

STEP FLEX 3

CARCASA GALVANIZADA / ACERO INOXIDABLE

Ø exterior tubo 1	Ø exterior tubo 2	Ref. EPDM	€ EPDM
914,4	884 - 944	STF30914E	Consultar
1.016,0	986 - 1046	STF31016E	Consultar
1.117,6	1087 - 1147	STF31117E	Consultar
1.219,2	1.189 - 1.249	STF31219E	Consultar
1.320,8	1.290 - 1.350	STF31320E	Consultar
1.422,4	1.392 - 1.452	STF31422E	Consultar
1.524,0	1.494 - 1.554	STF31524E	Consultar
1.600,0	1.570 - 1.630	STF31600E	Consultar
1.625,4	1.595 - 1.655	STF31625E	Consultar
1.727,2	1.697 - 1.757	STF31727E	Consultar
1.828,8	1.798 - 1.858	STF31828E	Consultar
1.930,4	1.900 - 1.960	STF31930E	Consultar
2.032,0	2.002 - 2.062	STF32032E	Consultar

Acoplamiento para tubos de cualquier material sin anclaje axial.
Unión para tuberías de diferentes materiales y diámetros.

Junta: EPDM: -20°C hasta +100°C
Fluido: EPDM: Todas las calidades de agua, aguas residuales, aire, sólidos y diversos productos químicos.



J1

STRAUB CLAMP

ABRAZADERAS SIMPLES DE REPARACIÓN / SCE / LONGITUD 200

Tolerancia (mm)	Código EPDM	€/Un. EPDM	Código NBR	€/Un. NBR
44-48	391-044-200	114,09	381-044-200	103,64
48-52	391-048-200	115,43	381-048-200	104,90
54-58	391-054-200	115,43	381-054-200	104,90
60-67	391-060-200	116,72	381-060-200	106,23
67-74	391-067-200	120,65	381-067-200	110,20
70-77	391-070-200	124,62	381-070-200	114,09
75-81	391-075-200	133,77	381-075-200	118,06
82-89	391-082-200	136,36	381-082-200	120,65
87-95	391-087-200	139,03	381-087-200	124,62
88-95	391-088-200	141,66	381-088-200	128,50
95-104	391-095-200	145,59	381-095-200	133,77
108-118	391-108-200	153,48	381-108-200	140,32
113-123	391-113-200	157,37	381-113-200	144,29
118-128	391-118-200	161,34	381-118-200	146,88
120-131	391-120-200	163,93	381-120-200	150,77
132-142	391-132-200	173,16	381-132-200	157,37
135-145	391-135-200	179,68	381-135-200	161,34
139-149	391-139-200	179,68	381-139-200	161,34
145-155	391-145-200	184,94	381-145-200	163,93
159-170	391-159-200	190,16	381-159-200	171,78
167-178	391-167-200	194,09	381-167-200	177,00
176-187	391-176-200	201,98	381-176-200	184,94
193-203	391-193-200	209,84	381-193-200	192,79
215-225	391-215-200	221,66	381-215-200	201,98
228-239	391-228-200	228,18	381-228-200	207,21
240-250	391-240-200	237,37	381-240-200	212,47
261-271	391-261-200	245,22	381-261-200	222,96
269-280	391-269-200	249,15	381-269-200	226,88

Material: Acero inoxidable AISI 304.

Juntas: EPDM o NBR.



J1

STRAUB CLAMP

ABRAZADERAS SIMPLES DE REPARACIÓN / SCE / LONGITUD 300

Tolerancia (mm)	Código EPDM	€/Un. EPDM	Código NBR	€/Un. NBR
44-48	391-044-300	128,50	381-044-300	115,43
48-52	391-048-300	135,10	381-048-300	119,31
54-58	391-054-300	137,73	381-054-300	123,32
60-67	391-060-300	173,16	381-060-300	157,37
67-74	391-067-300	184,94	381-067-300	163,93
70-77	391-070-300	187,57	381-070-300	167,85
75-81	391-075-300	191,46	381-075-300	173,16
82-89	391-082-300	199,31	381-082-300	183,60
87-95	391-087-300	201,98	381-087-300	184,94
88-95	391-088-300	204,62	381-088-300	187,57
95-104	391-095-300	209,84	381-095-300	192,79
108-118	391-108-300	221,66	381-108-300	201,98
113-123	391-113-300	228,18	381-113-300	207,21
118-128	391-118-300	240,00	381-118-300	215,10
120-131	391-120-300	242,63	381-120-300	220,32
132-142	391-132-300	253,12	381-132-300	229,51
135-145	391-135-300	263,56	381-135-300	241,30
139-149	391-139-300	263,56	381-139-300	241,30
145-155	391-145-300	268,83	381-145-300	245,22
159-170	391-159-300	281,98	381-159-300	255,71
167-178	391-167-300	288,50	381-167-300	259,68
176-187	391-176-300	299,07	381-176-300	271,50
193-203	391-193-300	308,22	381-193-300	280,65
215-225	391-215-300	333,12	381-215-300	301,66
228-239	391-228-300	351,46	381-228-300	318,70
240-250	391-240-300	377,69	381-240-300	343,60
261-271	391-261-300	390,85	381-261-300	354,05
269-280	391-269-300	420,97	381-269-300	382,91
280-291	391-280-300	424,90	381-280-300	388,22
315-325	391-315-300	499,68	381-315-300	453,81
320-330	391-320-300	515,38	381-320-300	468,22

Material: Acero inoxidable AISI 304.

Juntas: EPDM o NBR.



J1

STRAUB CLAMP

ABRAZADERAS SIMPLES DE REPARACIÓN / SCE / LONGITUD 400

Tolerancia (mm)	Código EPDM	€/Un. EPDM	Código NBR	€/Un. NBR
82-89	391-082-400	258,38	381-082-400	237,37
87-95	391-087-400	263,56	381-087-400	241,30
88-95	391-088-400	264,94	381-088-400	242,63
95-104	391-095-400	278,06	381-095-400	253,12
108-118	391-108-400	295,06	381-108-400	266,23
113-123	391-113-400	299,07	381-113-400	271,50
118-128	391-118-400	305,55	381-118-400	278,06
120-131	391-120-400	308,22	381-120-400	280,65
132-142	391-132-400	325,26	381-132-400	296,40
135-145	391-135-400	329,19	381-135-400	299,07
139-149	391-139-400	334,41	381-139-400	302,91
145-155	391-145-400	344,94	381-145-400	312,11
159-170	391-159-400	363,28	381-159-400	331,78
167-178	391-167-400	377,69	381-167-400	343,60
176-187	391-176-400	381,62	381-176-400	347,53
193-203	391-193-400	405,26	381-193-400	368,50
215-225	391-215-400	436,72	381-215-400	397,37

Material: Acero inoxidable AISI 304.

Juntas: EPDM o NBR.



J1

STRAUB CLAMP

ABRAZADERAS DOBLES DE REPARACIÓN / SCZ / LONGITUD 200

Tolerancia (mm)	Código EPDM	€/Un. EPDM	Código NBR	€/Un. NBR
88-108	392-088-200	240,00	382-088-200	215,10
100-120	392-100-200	243,93	382-100-200	221,66
108-128	392-108-200	250,53	382-108-200	228,18
114-134	392-114-200	253,12	382-114-200	229,51
120-140	392-120-200	255,71	382-120-200	233,44
130-150	392-130-200	260,97	382-130-200	240,00
140-160	392-140-200	268,83	382-140-200	245,22
159-180	392-159-200	274,09	382-159-200	249,15
168-189	392-168-200	281,98	382-168-200	255,71
190-210	392-190-200	299,07	382-190-200	271,50
210-230	392-210-200	310,81	382-210-200	283,24
218-238	392-218-200	323,93	382-218-200	295,06
240-260	392-240-200	346,19	382-240-200	313,48
269-289	392-269-200	405,26	382-269-200	368,50
282-302	392-282-200	418,38	382-282-200	380,32
315-335	392-315-200	438,02	382-315-200	398,70

Material: Acero inoxidable AISI 304.

Juntas: EPDM o NBR.



J1

STRAUB CLAMP

ABRAZADERAS DOBLES DE REPARACIÓN / SCZ / LONGITUD 300

Tolerancia (mm)	Código EPDM	€/Un. EPDM	Código NBR	€/Un. NBR
88-108	392-088-300	346,19	382-100-300	323,93
100-120	392-100-300	355,43	382-108-300	327,89
108-128	392-108-300	359,35	382-114-300	338,38
114-134	392-114-300	371,17	382-120-300	343,60
120-140	392-120-300	377,69	382-130-300	347,53
130-150	392-130-300	381,62	382-140-300	359,35
140-160	392-140-300	396,07	382-159-300	368,50
159-180	392-159-300	405,26	382-168-300	380,32
168-189	392-168-300	418,38	382-190-300	398,70
190-210	392-190-300	438,02	382-210-300	415,75
210-230	392-210-300	456,40	382-218-300	424,90
218-238	392-218-300	469,51	382-240-300	456,40
240-260	392-240-300	503,60	382-269-300	537,65
269-289	392-269-300	591,50	382-282-300	554,78
282-302	392-282-300	611,17	382-315-300	575,71
315-335	392-315-300	633,44	382-315-300	575,71
322-344	392-322-300	642,59	382-322-300	584,90
337-358	392-337-300	659,68	382-337-300	598,02
347-367	392-347-300	667,53	382-347-300	607,17

Material: Acero inoxidable AISI 304.

Juntas: EPDM o NBR.



J1

STRAUB CLAMP
ABRAZADERAS DOBLES DE REPARACIÓN / SCZ / LONGITUD 400

Tolerancia (mm)	Código EPDM	€/Un. EPDM	Código NBR	€/Un. NBR
88-108	392-088-400	452,43	382-088-400	410,49
100-120	392-100-400	466,84	382-100-400	423,60
108-128	392-108-400	472,11	382-108-400	430,16
114-134	392-114-400	481,30	382-114-400	436,72
120-140	392-120-400	491,78	382-120-400	447,25
130-150	392-130-400	499,68	382-130-400	453,81
140-160	392-140-400	515,38	382-140-400	468,22
159-180	392-159-400	528,54	382-159-400	481,30
168-189	392-168-400	537,65	382-168-400	487,85
190-210	392-190-400	573,12	382-190-400	520,65
210-230	392-210-400	598,02	382-210-400	544,25
218-238	392-218-400	612,43	382-218-400	556,03
240-260	392-240-400	663,60	382-240-400	603,32
269-289	392-269-400	771,13	382-269-400	701,62
282-302	392-282-400	796,03	382-282-400	723,97
315-335	392-315-400	817,04	382-315-400	742,31
322-344	392-322-400	832,79	382-322-400	758,06
337-358	392-337-400	857,69	382-337-400	780,32
347-367	392-347-400	881,30	382-347-400	798,66
365-385	392-365-400	916,68	382-365-400	832,79
390-410	392-390-400	950,81	382-390-400	864,29
410-430	392-410-400	974,41	382-410-400	886,56
420-440	392-420-400	988,87	382-420-400	898,38

Material: Acero inoxidable AISI 304.

Juntas: EPDM o NBR.

Recambios

INDUSTRIA





Recambios





INDUSTRIA

Recambios Válvulas manuales



VKD / VKR

Válvula de bola VK DUAL BLOCK® DN10+50.

d	DN	Ref. EPDM	€	Ref. FKM	€
16-20	10-15	SETVKD020E	20,06	SETVKD020F	44,14
25	20	SETVKD025E	24,54	SETVKD025F	45,60
32	25	SETVKD032E	33,26	SETVKD032F	51,83
40	32	SETVKD040E	45,22	SETVKD040F	68,03
50	40	SETVKD050E	53,93	SETVKD050F	81,45
63	50	SETVKD063E	72,29	SETVKD063F	138,38

Juego de juntas y asientos VKD / VKR.
Posiciones 3-5-8-9-10.

d	DN	Ref.	€
16-20	10-15	HSVVD020	14,65
25	20	HSVVD025	16,23
32	25	HSVVD032	17,21
40	32	HSVVD040	18,35
50	40	HSVVD050	20,97
63	50	HSVVD063	26,82

Maneta VKD / VKR.
Posiciones 3-5-8-9-10.

Set maneta VKD / VKR
compuesto por maneta y herramienta de apriete

d	DN	Ref.	€
16-20	10-15	DBVKD020025	20,64
25	20	DBVKD020025	20,64
32	25	DBVKD032	20,64
40	32	DBVKD040050	20,64
50	40	DBVKD040050	20,64
63	50	DBVKD063	20,64

VKD / VKR DUAL BLOCK® kit.
Posición 16.

d	DN	Ref. PVC-U	€	Ref. PP-H	€	Ref. PVDF	€	Ref. C-PVC	€
16-20	10-15	NTVKD020V	8,99	NTVKD020M	11,97	NTVKD020F	65,18	NTVKD020C	17,21
25	20	NTVKD025V	17,02	NTVKD025M	22,89	NTVKD025F	68,87	NTVKD025C	31,51
32	25	NTVKD032V	20,57	NTVKD032M	27,58	NTVKD032F	89,35	NTVKD032C	38,67
40	32	NTVKD040V	22,10	NTVKD040M	30,08	NTVKD040F	120,99	NTVKD040C	42,96
50	40	NTVKD050V	26,13	NTVKD050M	35,42	NTVKD050F	141,44	NTVKD050C	50,13
63	50	NTVKD063V	39,58	NTVKD063M	54,15	NTVKD063F	220,03	NTVKD063C	77,30

Tuerca VKD / VKR.
Posición 13.

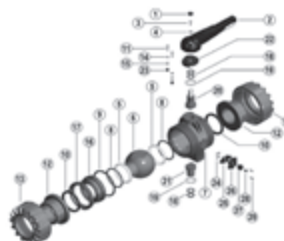

VKD

Válvula de bola VK DUAL BLOCK® DN65+100.

d	DN	Ref. EPDM	€	Ref. FKM	€
75	65	SETVKD075E	138,57	SETVKD075F	259,23
90	80	SETVKD090E	175,88	SETVKD090F	341,56
110	100	SETVKD110E (*)	262,20	SETVKD110F	431,32

Juego de juntas y asientos VKD.

Posiciones 5-8-9-10-18-19.

* No recomendable para la válvula VKD d 110 DN100 en PVDF

d	DN	Ref.	€
75	65	HSFKD0S14	52,99
90	80	HSFKD0M14	67,77
110	100	HSFKD0L17	74,92

Maneta VKD.

Posiciones 1-2-3-4.

Set maneta VKD compuesto por maneta y herramienta de apriete

d	DN	Ref. PVC-U	€	Ref. PP-H	€	Ref. PVDF	€	Ref. C-PVC	€
75	65	NTVKD075V	70,93	NTVKD075M	90,23	NTVKD075F	444,26	NTVKD075C	90,23
90	80	NTVKD090V	90,80	NTVKD090M	102,44	NTVKD090F	878,32	NTVKD090C	165,97
110	100	NTVKD110V	137,69	NTVKD110M	141,58	NTVKD110F	1.023,03	NTVKD110C	259,71

Tuerca VKD.

Posición 13.

d	DN	Ref.	€
75-110	65-100	DBVKD075110	30,06

VKD DUAL BLOCK® kit.

Posiciones 24-25-26-27-28-29.

d	DN	Ref.	€
75-110	65-100	UFFK160	26,59

Brida superior con trinquete VKD.

Posiciones 11-14-15-22-23.

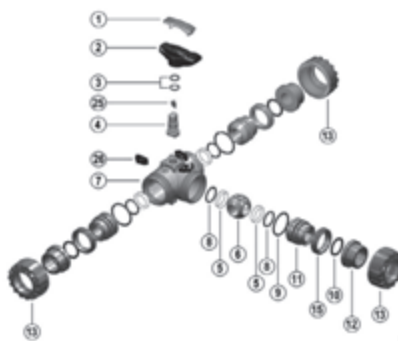

TKD

Válvula de bola 3 vías VK DUAL BLOCK®.

d	DN	Ref. EPDM	€	Ref. FKM	€
16-20	10-15	SETTKD020E	13,16	SETTKD020F	43,36
25	20	SETTKD025E	22,95	SETTKD025F	60,41
32	25	SETTKD032E	24,79	SETTKD032F	74,77
40	32	SETTKD040E	44,68	SETTKD040F	109,21
50	40	SETTKD050E	55,44	SETTKD050F	176,15
63	50	SETTKD063E	73,63	SETTKD063F	222,89

Juego de juntas y asientos TKD.
 Posiciones 3-5-8-9-10.

d	DN	Ref.	€	d	DN	Ref.	€	d	DN	Ref.	€
16-20	10-15	HSTKD020	14,65	16-20	10-15	DBTKD020025	20,64	16-20	10-15	PITKD020	1,87
25	20	HSTKD025	16,23	25	20	DBTKD020025	20,64	25	20	PITKD025032	1,87
32	25	HSTKD032	17,21	32	25	DBTKD032040	20,64	32	25	PITKD025032	1,87
40	32	HSTKD040	18,35	40	32	DBTKD032040	20,64	40	32	PITKD040050	1,87
50	40	HSTKD050	20,97	50	40	DBTKD050063	20,64	50	40	PITKD040050	1,87
63	50	HSTKD063	26,82	63	50	DBTKD050063	20,64	63	50	PITKD063	1,87

Maneta TKD.
 Posiciones 1-2.

Maneta y herramienta
 de apriete

TKD DUAL BLOCK® kit.
 Posición 26.

TKD indicador óptico.
 Posición 25.

d	DN	Ref. PVC-U	€	Ref. PP-H	€	Ref. C-PVC	€
16-20	10-15	NTVKD020V	8,99	NTVKD020M	11,97	NTVKD020C	17,21
25	20	NTVKD025V	17,02	NTVKD025M	22,89	NTVKD025C	31,51
32	25	NTVKD032V	20,57	NTVKD032M	27,58	NTVKD032C	38,67
40	32	NTVKD040V	22,10	NTVKD040M	30,08	NTVKD040C	42,96
50	40	NTVKD050V	26,13	NTVKD050M	35,42	NTVKD050C	50,13
63	50	NTVKD063V	39,58	NTVKD063M	54,15	NTVKD063C	77,30

Tuerca VKD.
 Posición 13.

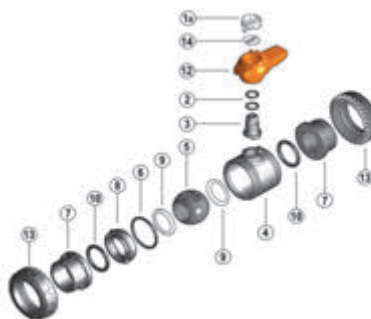

VXE

Válvula de bola VX Easyfit DN15+50.

d	DN	Ref. EPDM	€	Ref. FKM	€	d	DN	Ref.	€
16-20	10-15	SETVX020E	9,82	SETVX020F	29,05	16-20	10-15	HSVXE020	9,34
25	20	SETVX025E	12,96	SETVX025F	39,34	25	20	HSVXE025	11,06
32	25	SETVX032E	18,37	SETVX032F	48,81	32	25	HSVXE032	13,94
40	32	SETVX040E	27,68	SETVX040F	75,87	40	32	HSVXE040	21,72
50	40	SETVX050E	32,09	SETVX050F	102,96	50	40	HSVXE050	22,24
63	50	SETVX063E	48,90	SETVX063F	176,35	63	50	HSVXE063	33,60

Juego de juntas y asientos VXE.
 Posiciones 2-6-9-10.

Set maneta VXE. Maneta y tapón
 Posiciones 1a-12-14.

d	DN	Ref. PVC-U	€	Ref. C-PVC	€
16-20	10-15	NTVXE020V	8,58	NTVXE020C	14,25
25	20	NTVXE025V	9,65	NTVXE025C	27,32
32	25	NTVXE032V	11,58	NTVXE032C	32,27
40	32	NTVXE040V	15,23	NTVXE040C	35,14
50	40	NTVXE050V	18,80	NTVXE050C	41,99
63	50	NTVXE063V	24,49	NTVXE063C	63,46

Tuercas VXE. Posición 13.

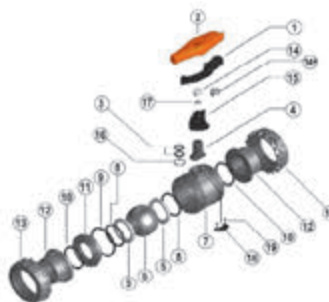

VXE

Válvula de bola VX Easyfit DN65+100.

d	DN	Ref. EPDM	€	Ref. FKM	€	d	DN	Ref.	€
75	65	SETVXE075E	55,79	SETVXE075F	188,85	75	65	HSVXE075	50,21
90	80	SETVXE090E	69,71	SETVXE090F	241,67	90	80	HSVXE090	50,76
110	100	SETVXE110E	83,43	SETVXE110F	292,05	110	100	HSVXE110	66,07

Juego de juntas y asientos VXE.
 Posiciones 3-5-8-9-10-16.

Set maneta VXE. Maneta y tapón
 Posiciones 1-2.

d	DN	Ref. PVC-U	€	Ref. C-PVC	€
75	65	NTVXE075V	70,93	NTVXE075C	78,10
90	80	NTVXE090V	90,80	NTVXE090C	101,56
110	100	NTVXE110V	137,69	NTVXE110C	143,54

Tuercas VXE. Posición 13.



VEE

Válvula de bola VE Easyfit DN15+50.

d	DN	Ref. EPDM	€
16-20	10-15	SETVE020E	4,20
25	20	SETVE025E	5,12
32	25	SETVE032E	7,18
40	32	SETVE040E	10,38
50	40	SETVE050E	15,54
63	50	SETVE063E	18,81

Juego de juntas y asientos VEE.
 Posiciones 2-6-9-10.

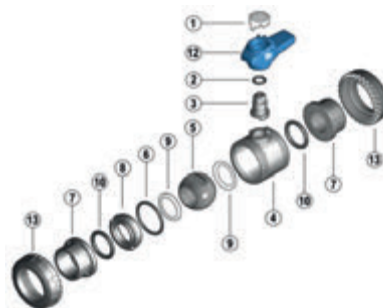

d	DN	Ref.	€
16-20	10-15	HSVEE020	9,34
25	20	HSVEE025	11,06
32	25	HSVEE032	13,94
40	32	HSVEE040	18,37
50	40	HSVEE050	22,24
63	50	HSVEE063	29,54

Maneta VEE.
 Posiciones 1-12.

Set maneta VEE
 compuesto por maneta y tapón



VEE

Válvula de bola VE Easyfit DN65+100.

d	DN	Ref. EPDM	€
75	75	SETVEE075E	19,99
90	90	SETVEE090E	24,74
110	110	SETVEE110E	31,43

Juego de juntas y asientos VEE.
 Posiciones 3-5-8-9-10-16.

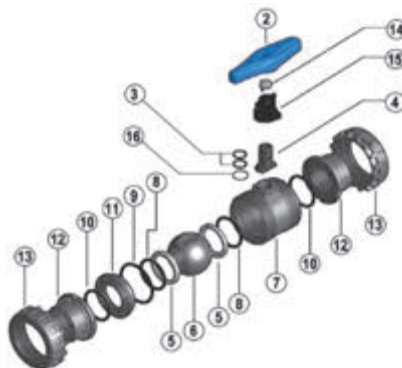

d	DN	Ref.	€
75	75	HAVEE075	37,42
90	90	HAVEE090	41,92
110	110	HAVEE110	47,78

Maneta VEE.
 Posición 2.

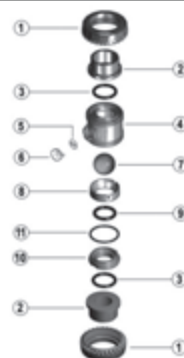

SXE

Válvula anti retorno de bola SX Easyfit DN10+50.

d	DN	Ref. EPDM	€	Ref. FKM	€
16-20	10-15	SETSXE020E	5,84	SETSXE020F	17,88
25	20	SETSXE025E	8,55	SETSXE025F	26,06
32	25	SETSXE032E	10,20	SETSXE032F	28,80
40	32	SETSXE040E	10,63	SETSXE040F	42,18
50	40	SETSXE050E	12,75	SETSXE050F	42,18
63	50	SETSXE063E	24,20	SETSXE063F	92,07

Juego de juntas y asientos SXE. Posiciones 3-9-11.

d	DN	Ref. PVC-U	€
16-20	10-15	BLSR020V	23,43
25	20	BLSR025V	23,43
32	25	BLSR032V	28,65
40	32	BLSR040V	46,86
50	40	BLSR050V	61,19
63	50	BLSR063V	85,29

Bola SXE. Posición 7.

d	DN	Ref. PVC-U	€
16-20	10-15	SESXE020V	4,70
25	20	SESXE025V	6,27
32	25	SESXE032V	5,09
40	32	SESXE040V	8,75
50	40	SESXE050V	7,69
63	50	SESXE063V	18,12

Casquillo SXE. Posición 10.

d	DN	Ref. PVC-U	€
16-20	10-15	PRSXE020V	5,70
25	20	PRSXE025V	7,02
32	25	PRSXE032V	9,52
40	32	PRSXE040V	10,46
50	40	PRSXE050V	12,78
63	50	PRSXE063V	15,17

Anillo de sujeción SXE. Posición 8

d	DN	Ref.	€	d	DN	Ref. PVC-U	€
32	25	LCE020	45,28	16-20	10-15	NTVXE020V	8,58
40	32	LCE025	45,49	25	20	NTVXE025V	9,65
50	40	LCE032	48,40	32	25	NTVXE032V	11,58
63	50	LCE032	48,40	40	32	NTVXE040V	15,23
				50	40	NTVXE050V	18,80
				63	50	NTVXE063V	24,49

Set LCE. Set tapón transparente + disco en PVC blanco (10 piezas de cada por set)

Posiciones 5-6.

Tuerca SXE. Posición 1.



SXE

Válvula anti retorno de bola SX Easyfit DN65+100.

d	DN	Ref. EPDM	€	Ref. FKM	l €
75	65	SETSXE075E	46,38	SETSXE075F	146,38
90	80	SETSXE090E	58,17	SETSXE090F	182,57
110	100	SETSXE110E	76,35	SETSXE110F	248,41

Juego de juntas y asientos SXE.

Posiciones 3-9-11.

d	DN	Ref. PVC-U	€
75	65	BLSXE075V	169,43
90	80	BLSXE090V	212,53
110	100	BLSXE110V	278,90

Bola SXE.

Posición 7.

d	DN	Ref. PVC-U	€
75	65	SESXE075V	32,18
90	80	SESXE090V	40,37
110	100	SESXE110V	52,97

Casquillo SXE.

Posición 10.

d	DN	Ref. PVC-U	€
75	65	PRSXE075V	40,58
90	80	PRSXE090V	50,89
110	100	PRSXE110V	66,79

Anillo de sujección SXE.

Posición 8

d	DN	Ref.	€
75	65	LCE063	66,68
90	80	LCE063	66,68
110	100	LCE063	66,68

Set LCE. Set tapón transparente + disco en PVC blanco (10 piezas de cada por set)

Posiciones 5-6.

d	DN	Ref. PVC-U	€	Ref. C-PVC	€
75	65	NTVXE075V	70,93	NTVXE075C	78,10
90	80	NTVXE090V	90,80	NTVXE090C	101,56
110	100	NTVXE110V	137,69	NTVXE110C	143,54

Tuerca SXE.

Posición 1.

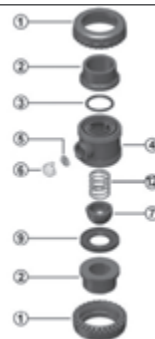

SSE

Válvula anti retorno con muelle SS Easyfit DN10+50.

d	DN	Ref. EPDM	€	Ref. FKM	€
16-20	10-15	SETSSE020E	5,15	SETSSE020F	15,09
25	20	SETSSE025E	7,50	SETSSE025F	21,98
32	25	SETSSE032E	8,97	SETSSE032F	24,29
40	32	SETSSE040E	9,32	SETSSE040F	35,57
50	40	SETSSE050E	11,18	SETSSE050F	35,57
63	50	SETSSE063E	21,19	SETSSE063F	77,57

Juego de juntas SSE.
 Posiciones 3-9.

d	DN	Ref. PVC-U	€	Ref. C-PVC	€
16-20	10-15	NTVXE020V	8,58	NTVXE020C	14,25
25	20	NTVXE025V	9,65	NTVXE025C	27,32
32	25	NTVXE032V	11,58	NTVXE032C	32,27
40	32	NTVXE040V	15,23	NTVXE040C	35,14
50	40	NTVXE050V	18,80	NTVXE050C	41,99
63	50	NTVXE063V	24,49	NTVXE063C	63,46

Tuerca SSE.
 Posición 1.

d	DN	Ref. muelle INOX A316	€	Ref. muelle INOX recubierto PTFE	€	Ref. muelle Hastelloy	€
16-20	10-15	ASSE020VX	20,53			ASSE020VH	61,18
25	20	ASSE025VX	20,53			ASSE025VH	57,54
32	25	ASSE032VX	25,08			ASSE032VH	65,18
40	32	ASSE040VX	41,06	ASSE040V0P	57,97		
50	40	ASSE050VX	53,62	ASSE050V0P	72,50		
63	50	ASSE063VX	74,77	ASSE063V0P	99,41		

Tapón + muelle SSE.
 Posiciones 7-12.

d	DN	Ref.	€
32	25	LCE020	Ver válvulas manuales
40	32	LCE025	Ver válvulas manuales
50-63	40-50	LCE032	Ver válvulas manuales

Tuerca SSE.
 Posición 1.

Set tapón transparente + disco en PVC blanco (10 piezas de cada por set)



SSE

Válvula anti retorno con muelle SS Easyfit DN65+100.

d	DN	Ref. EPDM	€	Ref. FKM	€
75	65	SETSXE075E	46,38	SETSXE075F	146,38
90	80	SETSXE090E	58,17	SETSXE090F	182,57
110	100	SETSXE110E	76,35	SETSXE110F	248,41

Juego de juntas SSE.
 Posiciones 3-9-11.

d	DN	Ref.	€
75	65	LCE063 Ver válvulas manuales	
90	80	LCE063 Ver válvulas manuales	
110	100	LCE063 Ver válvulas manuales	

Set LCE. Set tapón transparente + disco en PVC blanco (10 piezas de cada por set)
 Posiciones 5-6.

d	DN	Ref. muelle INOX A316	€	Ref. muelle INOX recubierto PTFE	€
75	65	ASSE075VX	148,46	ASSE075V0P	184,12
90	80	ASSE090VX	186,27	ASSE090V0P	229,29
110	100	ASSE110VX	244,40	ASSE110V0P	289,23

Tapón + muelle SSE.
 Posiciones 7-12.

d	DN	Ref. PVC-U	€	Ref. C-PVC	€
75	65	SESXE075V	32,18	SESXE075C	93,02
90	80	SESXE090V	40,37	SESXE090C	120,89
110	100	SESXE110V	52,97	SESXE110C	226,97

Casquillo SSE.
 Posición 10.

d	DN	Ref. PVC-U	€	Ref. C-PVC	€
75	65	PRSXE075V	40,58	PRSXE075C	121,83
90	80	PRSXE090V	50,89	PRSXE090C	157,37
110	100	PRSXE110V	66,79	PRSXE110C	295,48

Anillo sujeción SSE.
 Posición 8.

d	DN	Ref. PVC-U	€	Ref. C-PVC	€
75	65	NTVXE075V	70,93	NTVXE075C	78,10
90	80	NTVXE090V	90,80	NTVXE090C	101,56
110	100	NTVXE110V	137,69	NTVXE110C	143,54

Tuerca SSE.
 Posición 1.



SR

Válvula anti-retorno de bola DN15+50.

d	DN	Ref. EPDM	€	Ref. FKM	€
20	15	SETSR020E	6,27	SETSR020F	19,06
25	20	SETSR025E	6,27	SETSR025F	19,06
32	25	SETSR032E	7,11	SETSR032F	20,08
40	32	SETSR040E	8,29	SETSR040F	32,89
50	40	SETSR050E	14,33	SETSR050F	47,35
63	50	SETSR063E	17,88	SETSR063F	68,07

Juego de juntas SR. Posiciones 7-8-9.

d	DN	Ref. PPH	€	Ref. PVDF	€
20	15	BLSR020M	32,81	BLSR020F	47,04
25	20	BLSR025M	32,81	BLSR025F	53,94
32	25	BLSR032M	40,06	BLSR032F	128,63
40	32	BLSR040M	65,63	BLSR040F	166,38
50	40	BLSR050M	85,71	BLSR050F	293,79
63	50	BLSR063M	119,37	BLSR063F	447,70

Bola SR. Posición 2.

d	DN	Ref. PPH	€	Ref. PVDF	€
20	15	SESR020M	40,99	SESR020F	95,81
25	20	SESR025M	61,93	SESR025F	133,51
32	25	SESR032M	61,93	SESR032F	145,14
40	32	SESR040M	78,17	SESR040F	238,56
50	40	SESR050M	78,17	SESR050F	238,56
63	50	SESR063M	103,36	SESR063F	343,85

Casquillo SR. Posiciones 5-10.

d	DN	Ref. PPH	€	Ref. PVDF	€
20	15	PRSR020M	7,59	PRSR020F	24,67
25	20	PRSR025M	18,02	PRSR025F	30,80
32	25	PRSR032M	18,46	PRSR032F	40,67
40	32	PRSR040M	18,97	PRSR040F	70,22
50	40	PRSR050M	20,88	PRSR050F	87,50
63	50	PRSR063M	25,60	PRSR063F	112,16

Anillo sujeción SR. Posición 6.

d	DN	Ref. PPH	€	Ref. PVDF	€
20	15	NTVKD020M	11,97	NTVKD020F	65,18
25	20	NTVKD025M	22,89	NTVKD025F	68,87
32	25	NTVKD032M	27,58	NTVKD032F	89,35
40	32	NTVKD040M	30,08	NTVKD040F	120,99
50	40	NTVKD050M	35,42	NTVKD050F	141,44
63	50	NTVKD063M	54,15	NTVKD063F	220,03

Tuerca SR. Posición 4..



FE

Válvula de mariposa FE DN40+50.

d	DN	Ref. EPDM	€	Ref. FKM	€
50-63	40-50	SETFK063E	7,74	SETFK063F	18,03

Juego de juntas FE.
 Posiciones 6-7-13.

d	DN	Ref. EPDM	€	Ref. FKM	€
50	40	LIN050E	28,02	LIN050F	167,39
63	50	LIN063E	29,59	LIN063F	176,69

Juego primaria FE.
 Posición 15

d	DN	Ref.	€
50-63	40-50	HSFE0S11	39,53

Maneta FE. Con tornillo y tapón de protección
 Posiciones 1-2-3-4.

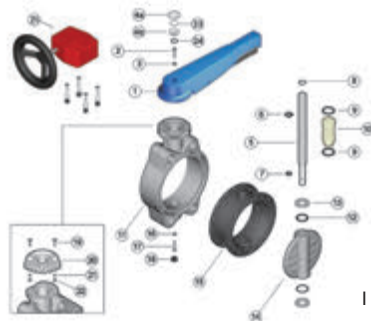

FE

Válvula de mariposa FE DN65+200.

d	DN	Ref. EPDM	€	Ref. FKM	€
75	65	SETFK075E	8,58	SETFK075F	20,06
90	80	SETFK090E	8,80	SETFK090F	20,06
110	100	SETFK110E	9,14	SETFK110F	20,06
140	125	SETFK140E	10,02	SETFK140F	21,40
160	150	SETFK160E	14,45	SETFK160F	26,79
225	200	SETFK225E	23,23	SETFK225F	41,52

Juego de juntas FE.
 Posiciones 6-7-9-12-13.

d	DN	Ref.	€
75	65	STFE075	77,86
90	80	STFE090	87,62
110	100	STFE110	97,33
140	125	STFE140	116,77
160	150	STFE160	136,26
225	200	STFE225	233,58

Eje FE.
 Posición 5.

d	DN	Ref. EPDM	€	Ref. FKM	€	Ref. NBR	€
75	65	LIN075E	31,18	LIN075F	185,95	LIN075N	34,26
90	80	LIN090E	34,33	LIN090F	232,75	LIN090N	37,81
110	100	LIN110E	41,86	LIN110F	335,83	LIN110N	46,03
140	125	LIN140E	56,79	LIN140F	476,21	LIN140N	62,52
160	150	LIN160E	62,97	LIN160F	612,74	LIN160N	69,25
225	200	LIN225E	110,98	LIN225F	1.072,89	LIN225N	122,12

Junta primaria FE.
 Posición 15.

d	DN	Ref. PVC-U	€
75	65	DISCV075	54,82
90	80	DISCV090	64,49
110	100	DISCV110	84,01
140	125	DISCV140	110,21
160	150	DISCV160	141,03
225	200	DISCV225	195,35

Disco FE.
 Posición 14.

d	DN	Ref.	€
75	65	HSFE0S11	39,53
90	80	HSFE0M14	44,09
110	100	HSFE0M14	44,09
140	125	HSFE0L17	48,81
160	150	HSFE0L17	48,81
225	200	HSFEXL22	86,77

Maneta FE.
 Posiciones 1-2-3-4.

Con tornillo y tapón de protección

d	DN	Ref.	€
75	65	GEAR01	360,74
90	80	GEAR01	360,74
110	100	GEAR01	360,74
140	125	GEAR02	360,74
160	150	GEAR02	360,74
225	200	GEAR03	441,31

Kit volante FE.
 Posición 29.

Con tornillos y brida si es necesaria

d	DN	Ref.	€
225	200	UFFE225	48,14

Brida superior con trinquete FE.
 Posiciones 19-20-21-22.



FK

Válvula de mariposa FK DN40+50.

d	DN	Ref. EPDM	€	Ref. FKM	€
50-63	40-50	SETFK063E	7,74	SETFK063F	18,03

Juego de juntas FK.
 Posiciones 17-18-23.

d	DN	Ref.	€
50-63	40-50	HSFKD0S11	51,33

Maneta FK. Con tornillo y tapón de protección
 Posiciones 2-3a-3b-4-5.

d	DN	Ref. EPDM	€	Ref. FKM	€
50	40	LIN050E	28,02	LIN050F	167,39
63	50	LIN063E	29,59	LIN063F	176,69

Juego primaria FK
 Posición 26.

d	DN	Ref. PVC-U	€	Ref. PP-H	€	Ref. PVDF	€	Ref. C-PVC	€
50	40	DISCV050	46,63	DISCM050	56,90	DISCF050	162,69	DISCC050	68,23
63	50	DISCV063	49,35	DISCM063	60,25	DISCF063	172,25	DISCC063	72,27

Disco FK.
 Posición 25.

d	DN	Ref.	€
50-63	40-50	UFFK160	26,59

Brida superior FK.
 Posiciones 7-10-11-12-28.

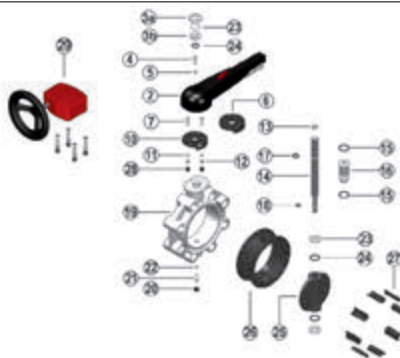

FK

Válvula de mariposa FK DN65+200.

d	DN	Ref. EPDM	€	Ref. FKM	€
75	65	SETFK075E	8,58	SETFK075F	20,06
90	80	SETFK090E	8,80	SETFK090F	20,06
110	100	SETFK110E	9,14	SETFK110F	20,06
140	125	SETFK140E	10,02	SETFK140F	21,40
160	150	SETFK160E	14,45	SETFK160F	26,79
225	200	SETFK225E	23,23	SETFK225F	41,52

Juego de juntas FK. Posiciones 15-17-18-23-24.

d	DN	Ref. PVC-U	€	Ref. PP-H	€	Ref. PVDF	€	Ref. C-PVC	€
75	65	DISCV075	54,82	DISCM075	66,97	DISCF075	191,38	DISCC075	80,26
90	80	DISCV090	64,49	DISCM090	77,64	DISCF090	201,63	DISCC090	93,69
110	100	DISCV110	84,01	DISCM110	92,29	DISCF110	215,68	DISCC110	104,37
140	125	DISCV140	110,21	DISCM140	121,23	DISCF140	281,67	DISCC140	126,90
160	150	DISCV160	141,03	DISCM160	141,81	DISCF160	302,58	DISCC160	149,30
225	200	DISCV225	195,35	DISCM225	215,15	DISCF225	382,64	DISCC225	225,05

Disco FK. Posición 25.

d	DN	Ref.	€
75-110	65-100	GEAR01	360,74
140-160	125-150	GEAR02	360,74
225	200	GEAR03	441,31

Kit volante FK. Posición 29.

Con tornillos y brida si es necesaria

d	DN	Ref.	€
75-160	65-150	UFFK160	26,59
225	200	UFFK225	40,41

Brida superior con trinquete FK.
 Posición 7-10-11-12-28.

d	DN	Ref. EPDM	€	Ref. FKM	€	Ref. NBR	€
75	65	LIN075E	31,18	LIN075F	185,95	LIN075N	34,26
90	80	LIN090E	34,33	LIN090F	232,75	LIN090N	37,81
110	100	LIN110E	41,86	LIN110F	335,83	LIN110N	46,03
140	125	LIN140E	56,79	LIN140F	476,21	LIN140N	62,52
160	150	LIN160E	62,97	LIN160F	612,74	LIN160N	69,25
225	200	LIN225E	110,98	LIN225F	1.072,89	LIN225N	122,12

Junta primaria FK. Posición 26.

d	DN	Ref.	€
75	65	HSFKD0S11	51,33
90-110	80-100	HSFKD0M14	67,77
140-160	125-150	HSFKD0L17	74,92
225	200	HSFKDXL22	110,55

Maneta FK.

Posición 2-3a-3b-4-5.

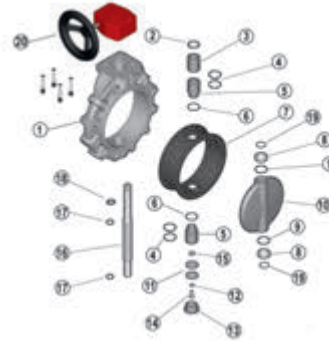

FK

Válvula de mariposa FK DN65+200.

d	DN	Ref. EPDM	€	Ref. FKM	€
280	250	SETFK315E	73,79	SETFK315F	132,10
315	300	SETFK315E	73,79	SETFK315F	132,10

Juego de juntas FK. Posiciones 15-17-18-23-24.

d	DN	Ref. EPDM	€	Ref. FKM	€
280	250	LIN280E	235,63	LIN280F	1.541,44
315	300	LIN315E	256,53	LIN315F	1.889,40

Junta primaria FK. Posición 7.

d	DN	Ref. PVC-U	€	Ref. PP-H	€	Ref. PVDF	€	Ref. C-PVC	€
280	250	DISCV280	377,66	DISCM280	427,24	DISCF280	687,07	DISCC280	453,61
315	300	DISCV315	411,79	DISCM315	467,39	DISCF315	750,03	DISCC315	494,38

Disco FK. Posición 10.

d	DN	Ref.	€
280-315	250-300	GEAR04	515,38

Kit volante FK. Posición 20. Con tornillos y brida si es necesaria

d	DN	Ref.	€
280	250	STFK280 (*)	506,06
315	300	STFK315 (*)	583,90

Eje FK. Posición 16.

(*) Para válvulas con el disco en PVDF usar los códigos STFK280F y STFL315F



FK

Válvula de mariposa FK DN355+400.

d	DN	Ref. EPDM	€	Ref. FKM	€
355-400	350-400	SETFK400E	62,50	SETFK400F	118,81

Juego de juntas FK. Posición 4-6-9-17.

d	DN	Ref. EPDM	€	Ref. FKM	€
355	350	LIN355E	494,20	LIN355F	3.609,88
400	400	LIN400E	574,13	LIN400F	5.072,44

Junta primaria FK. Posición 7.

d	DN	Ref. PVC-U	€	Ref. PP-H	€	Ref. PVDF	€
355	350	DISCV355	726,75	DISCM355	813,95	DISCF355	4.317,61
400	400	DISCV400	813,95	DISCM400	944,77	DISCF400	4.761,67

Disco FK. Posición 10.

d	DN	Ref.	€
355-400	350-400	GEAR05	897,32

Volante FK. Posición 20.

d	DN	Ref.	€
355	350	STFK355 (*)	703,13
400	400	STFK400 (*)	788,88

Eje FK. Posición 16.

(*) Sólo para válvulas con el disco en PVDF-U. Para otros materiales consultar

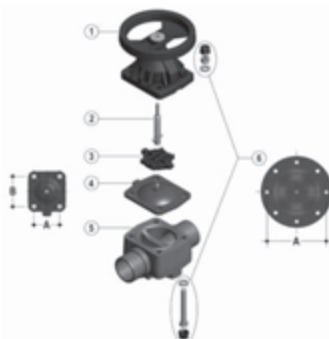

VM

Válvula de membrana VM.

d	DN	Ref. EPDM	€	Ref. FPM	€	Ref. PTFE	€	Ref. NBR	€
90	80	DIA090E	128,13	DIA090F	617,30	DIA090P	556,70	DIA090N	128,13
110	100	DIA110E	259,04	DIA110F	1.174,01	DIA110P	821,20	DIA110N	259,04

Membrana VM. Posición 4.

d	DN	Ref. PVC-U (EPDM / FKM)	€	Ref. PP-H (EPDM / FKM)	€	Ref. PVDF (EPDM / FKM)	€	Ref. C-PVC (EPDM / FKM)	€
90	80	SPBDVM090DV	234,33	SPBDVM090DM	292,91	SPBDVM090DF	1.396,23	SPBDVM090DC	458,87
110	100	SPBDVM110DV	312,42	SPBDVM110DM	331,95	SPBDVM110DF	2.030,82	SPBDVM110DC	591,65

d	DN	Ref. PVC-U (PTFE)	€	Ref. PP-H (PTFE)	€	Ref. PVDF (PTFE)	€	Ref. C-PVC (PTFE)	€
90	80	SPBDVMP090DV	259,71	SPBDVMP090DM	322,18	SPBDVMP090DF	1.434,24	SPBDVMP090DC	484,26
110	100	SPBDVMP110DV	341,74	SPBDVMP110DM	361,26	SPBDVMP110DF	2.068,87	SPBDVMP110DC	617,04

Cuerpo M-M VMD... Posición 5.

d	DN	Ref.	€
90	80	COVMMN075090	126,94
110	100	COVMMN110	136,70

Compresor VM. Posición 3.

d	DN	Ref.	€
90	80	BSVMMN75090X	111,29
110	100	BSVMMN110X	166,41

Cierres VM. Posiciones 10-11-12.

d	DN	Ref.	€
90	80	ATVMMN075090	537,00
110	100	ATVMMN110	722,50

Volante DK. Posiciones 1-2-6.

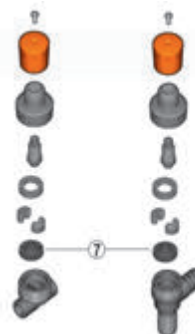

VM-RM

Grifo de membrana VM-RM.

d - Rh	DN	Ref.	€
12 - 1/4"	8	DIARM020E	10,64
20 - 1/2"	15	DIARM020E	10,64

Cierres VM. Posiciones 10-11-12.



DK

Válvula de membrana DK.

d	DN	Ref. EPDM	€	Ref. FKM	€	Ref. PTFE	€	Ref. NBR	€
20	15	DIA025E	28,99	DIA025F	94,53	DIADK025P	112,35	DIA025N	28,99
25	20	DIA025E	28,99	DIA025F	94,53	DIADK025P	112,35	DIA025N	28,99
32	25	DIA032E	30,27	DIA032F	104,68	DIADK032P	128,13	DIA032N	30,27
40	32	DIA032E	30,27	DIA032F	104,68	DIADK032P	128,13	DIA032N	30,27
50	40	DIA050E	37,18	DIA050F	177,75	DIADK050P	212,22	DIA050N	37,18
63	50	DIA063E	55,13	DIA063F	253,58	DIADK063P	260,35	DIA063N	55,13
75	65	DIA063E	55,13	DIA063F	253,58	DIADK063P	260,35	DIA063N	55,13

Membrana DK.

Posición 7.

d	DN	Ref. PVC-U	€	Ref. PP-H	€	Ref. PVDF	€	Ref. C-PVC	€
20	15	SPBDDK020DV	34,13	SPBDDK020DM	46,29	SPBDDK020DF	136,58	SPBDDK020DC	50,17
25	20	SPBDDK025DV	36,78	SPBDDK025DM	51,49	SPBDDK025DF	146,77	SPBDDK025DC	57,91
32	25	SPBDDK032DV	49,42	SPBDDK032DM	72,67	SPBDDK032DF	180,70	SPBDDK032DC	79,07
40	32	SPBDDK040DV	52,84	SPBDDK040DM	73,13	SPBDDK040DF	264,27	SPBDDK040DC	91,22
50	40	SPBDDK050DV	64,87	SPBDDK050DM	123,61	SPBDDK050DF	323,47	SPBDDK050DC	118,95
63	50	SPBDDK063DV	85,12	SPBDDK063DM	148,27	SPBDDK063DF	435,44	SPBDDK063DC	123,81
75	65	SPBDDK075DV	119,15	SPBDDK075DM	207,58	SPBDDK075DF	609,60	SPBDDK075DC	173,35

Cuerpo M-M DKD...

Posición 8.

Cuerpo DK con spigots para encolar macho serie métrica

d	DN	Ref. PVC-U	€	Ref. PP-H	€	Ref. PVDF	€	Ref. C-PVC	€
20	15	UNBDDK020V	36,23	UNBDDK020M	80,77	UNBDDK020F	144,86	UNBDDK020C	87,05
25	20	UNBDDK025V	40,47	UNBDDK025M	86,70	UNBDDK025F	161,52	UNBDDK025C	98,49
32	25	UNBDDK032V	54,85	UNBDDK032M	109,71	UNBDDK032F	200,58	UNBDDK032C	133,29
40	32	UNBDDK040V	61,12	UNBDDK040M	122,27	UNBDDK040F	295,59	UNBDDK040C	154,44
50	40	UNBDDK050V	81,95	UNBDDK050M	156,10	UNBDDK050F	339,86	UNBDDK050C	195,11
63	50	UNBDDK063V	104,73	UNBDDK063M	193,37	UNBDDK063F	460,35	UNBDDK063C	233,63

Cuerpo con enlace DKU...

Posición 8.

Cuerpo DK con enlaces para encolar hembra

Continúa en la página siguiente...



DK

Válvula de membrana DK.

d	DN	Ref. PVC-U	€	Ref. PP-H	€	Ref. PVDF	€	Ref. C-PVC	€
20	15	FLBDDK020OV	90,54	FLBDDK020OM	127,51	FLBDDK020OF	314,02	FLBDDK020OC	153,01
25	20	FLBDDK025OV	102,36	FLBDDK025OM	139,53	FLBDDK025OF	329,12	FLBDDK025OC	179,24
32	25	FLBDDK032OV	128,29	FLBDDK032OM	177,23	FLBDDK032OF	381,11	FLBDDK032OC	212,76
40	32	FLBDDK040OV	158,78	FLBDDK040OM	215,37	FLBDDK040OF	604,63	FLBDDK040OC	261,15
50	40	FLBDDK050OV	200,20	FLBDDK050OM	268,67	FLBDDK050OF	677,67	FLBDDK050OC	315,49
63	50	FLBDDK063OV	249,00	FLBDDK063OM	337,67	FLBDDK063OF	872,35	FLBDDK063OV	392,30

Cuerpo con bridas DKO...
 Posición 8.

Cuerpo DK con bridas PN10/16 FF EN 558-1
 Disponible también con bridas ANSI 150 lbs. al mismo precio

d	DN	Ref.	€
20 ÷ 25	15 ÷ 20	CODK020025	18,10
32 ÷ 40	25 ÷ 32	CODK032040	19,78
50	40	COVMMN040050	25,25
63 ÷ 75	50 ÷ 65	COVMMN063	32,77

Compresor DK.
 Posición 6.

d	DN	Ref.	€
20 ÷ 25	15 ÷ 20	ATDKMN020025	69,14
32 ÷ 40	25 ÷ 32	ATDKMN032040	99,57
50	40	ATDKMN050	137,10
63 ÷ 75	50 ÷ 65	ATDKMN063075	167,47

Volante DK.
 Posiciones 1-2-3-4-5-6.

d	DN	Ref.	€
20 ÷ 40	15 ÷ 32	TCSDKMN02004	19,75
50	40	TCSDKMN050	25,00
63 ÷ 75	50 ÷ 65	TCSDKMN06307	28,55

Tapón transparente DK.
 Posiciones 1-2-3.

d	DN	Ref.	€
20 ÷ 25	15 ÷ 20	BSDK020025X	24,08
32 ÷ 40	25 ÷ 32	BSVM020032X	33,18
50	40	BSVM040050X	39,04
63 ÷ 75	50 ÷ 65	BSVM063X	48,90

Kit cierre DK.
 Posiciones 12-13-14.

Compuesto por tornillos,
 tuercas y tapones protectores

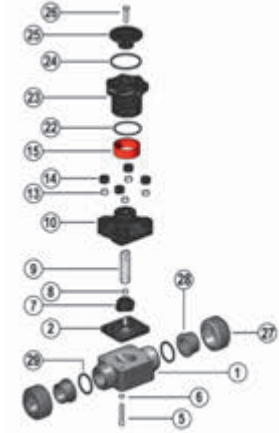

CM

Válvula de membrana compacta CM.

d	DN	Ref. EPDM	€	Ref. FKM	€	Ref. PTFE	€
16 - 20	10 - 15	DIACM020E	24,82	DIACM020F	81,31	DIACM020P	74,42

Membrana CM.

Posición 2.

d	DN	Ref. PVC-U (EPDM / FKM)	€	Ref. PP-H (EPDM / FKM)	€	Ref. PVDF (EPDM / FKM)	€	Ref. C-PVC (EPDM / FKM)	€
16 - 20	10 - 15	SPBDCM020DV	24,94	SSPBDCM020DM	33,27	SPBDCM020DF	119,01	SPBDCM020DC	83,22

d	DN	Ref. PVC-U (PTFE)	€	Ref. PP-H (PTFE)	€	Ref. PVDF (PTFE)	€	Ref. C-PVC (PTFE)	€
16 - 20	10 - 15	SPBDCMQ020DV	41,60	SPBDCMQ020DM	49,90	SPBDCMQ020DF	140,61	SPBDCMQ020DC	99,85

Cuerpo M-M CMD...

Posición 1.

Cuerpo CM con spigots para membranas EPDM / FPM o PTFE

d	DN	Ref. PVC-U (EPDM / FKM)	€	Ref. PP-H (EPDM / FKM)	€	Ref. PVDF (EPDM / FKM)	€	Ref. C-PVC (EPDM / FKM)	€
16 - 20	10 - 15	UNBDCM020V	49,90	UNBDCM020M	58,21	UNBDCM020F	151,42	UNBDCM020C	108,42

d	DN	Ref. PVC-U (PTFE)	€	Ref. PP-H (PTFE)	€	Ref. PVDF (PTFE)	€	Ref. C-PVC (PTFE)	€
16 - 20	10 - 15	UNBDCMQ020V	66,56	UNBDCMQ020M	74,92	UNBDCMQ020F	173,06	UNBDCMQ020C	125,03

Cuerpo con enlace CMU...

Posición 1.

Cuerpo CM con enlaces para membranas EPDM / FKM o PTFE

Continúa en la página siguiente...

d	DN	Ref. PVC-U (EPDM / FKM)	€	Ref. PP-H (EPDM / FKM)	€	Ref. PVDF (EPDM / FKM)	€
16	10	SKBDCM016IV	38,73	SKBDCM016IM	54,68	SKBDCM016IF	119,01
20	15	SKBDCM020IV	38,73	SKBDCM020IM	54,68	SKBDCM020IF	119,01

d	DN	Ref. PVC-U (PTFE)	€	Ref. PP-H (PTFE)	€	Ref. PVDF (FKM)	€
16	10	SKBDCMQ016IV	55,35	SKBDCMQ016IM	72,25	SKBDCMQ016IF	140,61
20	15	SKBDCMQ020IV	55,35	SKBDCMQ020IM	72,25	SKBDCMQ020IF	140,61

Cuerpo H-H CMI...
 Posición 1.

Cuerpo CM H-H para membranas EPDM / FKM o PTFE

Rh	DN	Ref. PVC-U (EPDM / FKM)	€	Ref. PP-H (EPDM / FKM)	€	Ref. PVDF (EPDM / FKM)	€
3/8"	10	TRBDCM038FV	38,73	TRBDCM038FM	54,68	TRBDCM038FF	119,01
1/2"	15	TRBDCM012FV	38,73	TRBDCM012FM	54,68	TRBDCM012FF	119,01

Rh	DN	Ref. PVC-U (PTFE)	€	Ref. PP-H (PTFE)	€	Ref. PVDF (FKM)	€
3/8"	10	TRBDCMQ038FV	55,35	TRBDCMQ038FM	72,25	TRBDCMQ038FF	140,61
1/2"	15	TRBDCMQ012FV	55,35	TRBDCMQ012FM	72,25	TRBDCMQ012FF	140,61

Cuerpo H-H roscado CMF...
 Posición 1.

Cuerpo CM H-H roscado para membranas EPDM / FKM o PTFE

d	DN	Ref. PVC-U	€	Ref. PP-H	€	Ref. PVDF	€	Ref. C-PVC	€
20	15	EFV100	1,99	EFM020	6,85	EFF020	27,95	EFC100	8,01

Tuercas CM.
 Posición 27.

Tuercas para cuerpo CM con enlaces

d	DN	Ref.	€
16 - 20	10 - 15	ATCMMN	98,85

Volante CM.
 Posiciones 7-26.

d	DN	Ref.	€
16 - 20	10 - 15	BSCMX	20,17

Kit Cierre CM.
 Posiciones 5-6.

Compuesto por tornillos, tuercas y tapones protectores

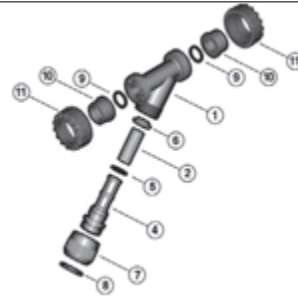

RV

Filtro inclinado RV DN10÷50.

d	DN	Ref. EPDM	€	Ref. FKM	€
16-20	10-15	SETRV020E	3,40	SETRV020F	27,56
25	20	SETRV025E	5,09	SETRV025F	37,18
32	25	SETRV032E	5,09	SETRV032F	37,18
40	32	SETRV040E	8,17	SETRV040F	59,22
50	40	SETRV050E	8,17	SETRV050F	59,22
63	50	SETRV063E	11,70	SETRV063F	85,39

Juego de juntas RV. Posiciones 5-9.

d	DN	Ref. PVC-U luz 0,3 mm.	€	Ref. PVC-U luz 0,5 mm. *	€	Ref. PVC-U luz 0,7 mm.	€	Ref. PVC-U luz 0,9 mm.	€
16-20	10-15	SCR10V020	6,92	SCR15V020	6,92	SCR20V020	6,92	SCR25V020	6,92
25	20	SCR10V025	7,61	SCR15V025	7,61	SCR20V025	4,72	SCR25V025	7,61
32	25	SCR10V032	7,98	SCR15V032	7,98	SCR20V032	7,98	SCR25V032	7,98
40	32	SCR10V040	9,73	SCR15V040	9,73	SCR20V040	9,73	SCR25V040	9,73
50	40	SCR10V050	9,73	SCR15V050	9,73	SCR20V050	9,73	SCR25V050	9,73
63	50	SCR10V063	11,46	SCR15V063	11,46	SCR20V063	11,46	SCR25V063	11,46

* Estándar en los filtros de PVC-U

d	DN	Ref. PP luz 0,5 mm. **	€	Ref. Inox luz 0,3 mm.	€
16-20	10-15	SCR15M020	9,34	SCR07X020	8,48
25	20	SCR15M025	10,01	SCR07X025	9,08
32	25	SCR15M032	10,81	SCR07X032	9,73
40	32	SCR15M040	12,25	SCR07X040	11,46
50	40	SCR15M050	13,64	SCR07X050	11,70
63	50	SCR15M063	16,55	SCR07X063	13,84

Mallas RV. Posición 2.

** Estándar en los filtros de PP y C-PVC

d	DN	Ref. PVC-U	€	Ref. PVC transparente	€
16	10	SPBDRV016DV	20,85	SPBDRV016DT	24,74
20	15	SPBDRV020DV	22,78	SPBDRV020DT	24,74
25	20	SPBDRV025DV	28,26	SPBDRV025DT	30,32
32	25	SPBDRV032DV	30,32	SPBDRV032DT	30,32
40	32	SPBDRV040DV	44,36	SPBDRV040DT	44,36
50	40	SPBDRV050DV	62,08	SPBDRV050DT	62,08
63	50	SPBDRV063DV	91,64	SPBDRV063DT	101,65

Cuerpo M-M RVD. Posición 1.

Continúa en la página siguiente...

d	DN	Ref. PVC-U	€	Ref. PVC transparente	€	Ref. PP-H	€	Ref. C-PVC	€
16-20	10-15	UNBDRV020V	22,78	UNBDRV020T	24,74	UNBDRV020M	54,68	UNBDRV020C	74,19
25	20	UNBDRV025V	28,26	UNBDRV025T	30,32	UNBDRV025M	58,59	UNBDRV025C	82,03
32	25	UNBDRV032V	30,32	UNBDRV032T	30,32	UNBDRV032M	62,49	UNBDRV032C	87,89
40	32	UNBDRV040V	44,36	UNBDRV040T	44,36	UNBDRV040M	66,38	UNBDRV040C	113,28
50	40	UNBDRV050V	62,08	UNBDRV050T	62,08	UNBDRV050M	95,66	UNBDRV050C	162,07
63	50	UNBDRV063V	91,64	UNBDRV063T	101,65	UNBDRV063M	111,29	UNBDRV063C	164,89

Cuerpo con enlaces RVU... Posición 1.

d	DN	Ref.	€
16-20	10-15	SRRV020V	6,12
25	20	SRRV025V	9,10
32	25	SRRV032V	11,37
40	32	SRRV040V	14,05
50	40	SRRV050V	17,21
63	50	SRRV063V	20,38

Anillo cierre RV. Posición 8.

d	DN	Ref. PVC-U	€	Ref. PP-H	€	Ref. C-PVC	€
16-20	10-15	SURV020V	17,02	SURV020M	46,63	SURV020C	44,92
25	20	SURV025V	24,08	SURV025M	55,84	SURV025C	58,59
32	25	SURV032V	27,45	SURV032M	65,85	SURV032C	70,27
40	32	SURV040V	28,26	SURV040M	68,34	SURV040C	68,34
50	40	SURV050V	49,07	SURV050M	72,25	SURV050C	82,03
63	50	SURV063V	58,04	SURV063M	78,10	SURV063C	99,58

Soporte malla RV. Posición 4.

d	DN	Ref. PVC-U	€	Ref. PP-H	€	Ref. C-PVC	€
16-20	10-15	NTVKD020V	8,99	NTVKD020M	11,97	NTVKD020C	17,21
25	20	NTVKD025V	17,02	NTVKD025M	22,89	NTVKD025C	31,51
32	25	NTVKD032V	20,57	NTVKD032M	27,58	NTVKD032C	38,67
40	32	NTVKD040V	22,10	NTVKD040M	30,08	NTVKD040C	42,96
50	40	NTVKD050V	26,13	NTVKD050M	35,42	NTVKD050C	50,13
63	50	NTVKD063V	39,58	NTVKD063M	54,15	NTVKD063C	77,30

Tuerca unión RV. Posición 11.

d	DN	Ref. PVC-U	€	Ref. PP-H	€	Ref. C-PVC	€
16-20	10-15	RRRV020V	8,84	RRRV020M	13,64	RRRV020C	19,53
25	20	RRRV025V	12,17	RRRV025M	17,21	RRRV025C	22,47
32	25	RRRV032V	14,72	RRRV032M	20,06	RRRV032C	23,43
40	32	RRRV040V	19,27	RRRV040M	23,64	RRRV040C	25,38
50	40	RRRV050V	28,20	RRRV050M	27,21	RRRV050C	33,18
63	50	RRRV063V	34,38	RRRV063M	37,21	RRRV063C	41,00

Anillo sujeción RV. Posición 6.

d	DN	Ref. PVC-U	€	Ref. PP-H	€	Ref. C-PVC	€
16-20	10-15	BNRV020V	22,95	BNRV020M	43,50	BNRV020C	50,77
25	20	BNRV025V	27,56	BNRV025M	58,54	BNRV025C	66,38
32	25	BNRV032V	31,78	BNRV032M	78,83	BNRV032C	82,03
40	32	BNRV040V	36,58	BNRV040M	86,21	BNRV040C	91,76
50	40	BNRV050V	42,82	BNRV050M	87,89	BNRV050C	97,64
63	50	BNRV063V	47,97	BNRV063M	89,80	BNRV063C	101,56

Tuerca cierre RV. Posición 7.

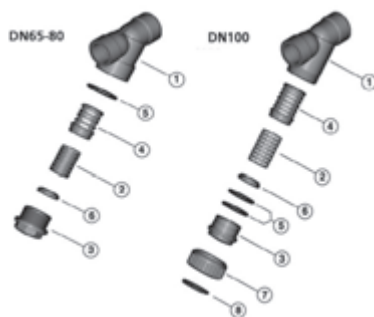

RV

Filtro inclinado RV DN65+100.

d	DN	Ref. EPDM	€	Ref. FKM	€
75	65	SETRV075E	15,20	SETRV075F	110,24
90	80	SETRV090E	27,10	SETRV090F	197,01
110	100	SETRV110E	33,79	SETRV110F	243,96

Juego de juntas RV. Posición 5.

d	DN	Ref. PVC-U luz 0,3 mm.	€	Ref. PVC-U luz 0,5 mm. *	€	Ref. PVC-U luz 0,7 mm.	€	Ref. PVC-U luz 0,9 mm.	€
75	65	SCR10V075	23,24	SCR15V075	23,24	SCR20V075	23,24	SCR25V075	23,24
90	80	SCR10V090	28,94	SCR15V090	28,94	SCR20V090	28,94	SCR25V090	28,94
110	100	SCR10V110	42,96	SCR15V110	42,96	SCR20V110	42,96	SCR25V110	42,96

* Estándar en los filtros de PVC-U

d	DN	Ref. PP luz 0,5 mm. **	€	Ref. Inox luz 0,3 mm.	€
75	65	SCR15M075	22,10	SCR07X075	45,65
90	80	SCR15M090	27,97	SCR07X090	53,19
110	100	SCR15M110	40,87	SCR07X110	75,87

Mallas RV. Posición 2.

** Estándar en los filtros de PP y C-PVC

d	DN	Ref. PVC-U	€	Ref. PVC transparente	€	Ref. PP-H	€
75	65	SKBDRV075IV	167,02	SKBDRV075IT	225,61	SKBDRV075IM	374,90
90	80	SKBDRV090IV	217,15	SKBDRV090IT	327,39	SKBDRV090IM	549,89
110	100	SKBDRV110IV	368,94	SKBDRV110IT	501,21	SKBDRV110IM	731,61

Cuerpo H-H encolar RVI... Posición 1.

Rh	DN	Ref. PVC-U	€	Ref. PVC transparente	€
2½"	65	TRBDRV212FV	167,02	TRBDRV212FT	225,61
3"	80	TRBDRV300FV	217,15	TRBDRV300FT	327,39
4"	100	TRBDRV400FV	368,94	TRBDRV400FT	501,21

Cuerpo H-H roscar RVI... Posición 1.

** Estándar en los filtros de PP y C-PVC

d	DN	Ref. PVC-U	€	Ref. PP-H	€	d	DN	Ref.	€
110	100	BNRV110V	139,18	BNRV110M	197,72	110	100	SRRV110V	35,42

Tuerca cierre RV. Posición 7.

Anillo cierre RV. Posición 8.

d	DN	Ref. PVC-U	€	Ref. PP-H	€
75	65	RRRV075V	63,00	RRRV075M	47,23
90	80	RRRV090V	65,98	RRRV090M	60,12
110	100	RRRV110V	83,57	RRRV110M	118,20

Anillo sujeción RV. Posición 6.

Continúa en la página siguiente...

d	DN	Ref. PVC-U	€	Ref. PP-H	€
75	65	BORV075V	71,59	BORV075M	130,18
90	80	BORV090V	84,61	BORV090M	156,20
110	100	BORV110V	136,70	BORV110M	286,41

Tapón RV. Posición 3.

d	DN	Ref. PVC-U	€	Ref. PP-H	€
75	65	SURV075V	51,55	SURV075M	63,03
90	80	SURV090V	65,85	SURV090M	65,85
110	100	SURV110V	70,18	SURV110M	83,57

SopORTE malla RV. Posición 4.

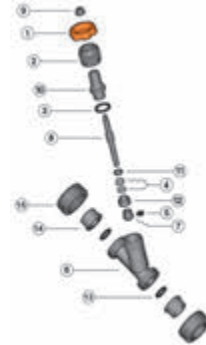

VV

Válvula de asiento inclinado VV DN10+50.

d	DN	Ref. EPDM / PTFE	€	Ref. FKM / PTFE	€	d	DN	Ref.	€
16-20	10-15	SETVV020EP	5,77	SETVV020FP	28,00	16-20	10-15	HWVV020	9,34
25	20	SETVV025EP	7,11	SETVV025FP	33,11	25	20	HWVV025	10,18
32	25	SETVV032EP	10,99	SETVV032FP	39,82	32	25	HWVV032	16,27
40	32	SETVV040EP	14,62	SETVV040FP	57,65	40	32	HWVV040	19,75
50	40	SETVV050EP	14,62	SETVV050FP	64,19	50	40	HWVV050	25,38
63	50	SETVV063EP	14,62	SETVV063FP	90,62	63	50	HWVV063	29,30

Juego de juntas VV. Posiciones 3-4-13.

Volante VV. Posiciones 1-9.

d	DN	Ref.	€	d	DN	Ref. PVC-U	€	Ref. PVC-U / EPDM	€	Ref. PVC-U / EPDM	€
16	10	SPBDRV016DV	20,85	16	10	UNBDRV020V	22,78	ASVV020VE	35,01	ASVV020VF	35,01
20	15	SPBDRV020DV	22,78	20	15	UNBDRV020V	22,78	ASVV020VE	35,01	ASVV020VF	35,01
25	20	SPBDRV025DV	28,26	25	20	UNBDRV025V	28,26	ASVV025VE	42,21	ASVV025VF	42,21
32	25	SPBDRV032DV	30,32	32	25	UNBDRV032V	30,32	ASVV032VE	49,18	ASVV032VF	49,18
40	32	SPBDRV040DV	44,36	40	32	UNBDRV040V	44,36	ASVV040VE	75,30	ASVV040VF	75,30
50	40	SPBDRV050DV	62,08	50	40	UNBDRV050V	62,08	ASVV050VE	95,25	ASVV050VF	95,25
63	50	SPBDRV063DV	91,64	63	50	UNBDRV063V	91,64	ASVV063VE	123,25	ASVV063VF	123,25

Cuerpo M-M VVD... Posición 6.

Cuerpo con enlaces VVU. Posición 6.

Eje VV. Posiciones 5-7-8-10-11-12.

d	DN	Ref. PVC-U	€
16-20	10-15	NTVKD020V	8,99
25	20	NTVKD025V	17,02
32	25	NTVKD032V	20,57
40	32	NTVKD040V	22,10
50	40	NTVKD050V	26,13
63	50	NTVKD063V	39,58

Tuerca unión VV. Posición 15.

d	DN	Ref. PVC-U	€
16-20	10-15	BNRV020V	22,95
25	20	BNRV025V	27,56
32	25	BNRV032V	31,78
40	32	BNRV040V	36,58
50	40	BNRV050V	42,82
63	50	BNRV063V	47,97

Tuerca cierre VV. Posición 2.

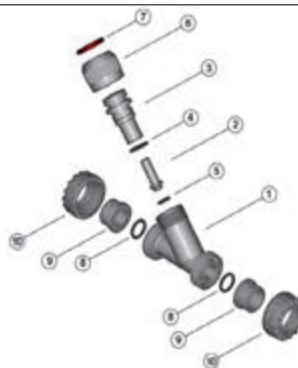

VR

Válvula anti retorno inclinada VR DN10+50.

d	DN	Ref. EPDM	€	Ref. FKM	€
16-20	10-15	SETVR020E	1,69	SETVR020F	13,84
25	20	SETVR025E	2,15	SETVR025F	16,66
32	25	SETVR032E	2,94	SETVR032F	23,57
40	32	SETVR040E	4,09	SETVR040F	39,34
50	40	SETVR050E	4,53	SETVR050F	55,13
63	50	SETVR063E	4,99	SETVR063F	86,77

Juego de juntas VR.
 Posiciones 4-5-6.

d	DN	Ref. PVC-U	€
16	10	SPBDRV016DV	20,85
20	15	SPBDRV020DV	22,78
25	20	SPBDRV025DV	28,26
32	25	SPBDRV032DV	30,32
40	32	SPBDRV040DV	44,36
50	40	SPBDRV050DV	62,08
63	50	SPBDRV063DV	91,64

Cuerpo M-M VRDV.
 Posición 1.

d	DN	Ref.	€
16	10	SRRV020V	6,12
20	15	SRRV020V	6,12
25	20	SRRV025V	9,10
32	25	SRRV032V	11,37
40	32	SRRV040V	14,05
50	40	SRRV050V	17,21
63	50	SRRV063V	20,38

Anillo cierre VR.
 Posición 7.

d	DN	Ref. PVC-U	€	Ref. PP-H	€
16-20	10-15	UNBDRV020V	22,78	UNBDRV020M	54,68
25	20	UNBDRV025V	28,26	UNBDRV025M	58,59
32	25	UNBDRV032V	30,32	UNBDRV032M	62,49
40	32	UNBDRV040V	44,36	UNBDRV040M	66,38
50	40	UNBDRV050V	62,08	UNBDRV050M	95,66
63	50	UNBDRV063V	91,64	UNBDRV063M	111,29

Cuerpo con enlaces VRU...
 Posición 1.

Continúa en la página siguiente...

d	DN	Ref. PVC-U	€	Ref. PP-H	€
16-20	10-15	BOVR020V	24,44	BOVR020M	46,22
25	20	BOVR025V	25,52	BOVR025M	54,15
32	25	BOVR032V	27,70	BOVR032M	68,73
40	32	BOVR040V	38,89	BOVR040M	91,64
50	40	BOVR050V	50,34	BOVR050M	96,74
63	50	BOVR063V	74,92	BOVR063M	103,88

Porta pistón VR.
Posición 3.

d	DN	Ref. PVC-U	€	Ref. PP-H	€
16-20	10-15	NTVKD020V	8,99	NTVKD020M	11,97
25	20	NTVKD025V	17,02	NTVKD025M	22,89
32	25	NTVKD032V	20,57	NTVKD032M	27,58
40	32	NTVKD040V	22,10	NTVKD040M	30,08
50	40	NTVKD050V	26,13	NTVKD050M	35,42
63	50	NTVKD063V	39,58	NTVKD063M	54,15

Tuerca unión VR.
Posición 10.

d	DN	Ref. PVC-U	€	Ref. PP-H	€
16-20	10-15	BNRV020V	22,95	BNRV020M	43,50
25	20	BNRV025V	27,56	BNRV025M	58,54
32	25	BNRV032V	31,78	BNRV032M	78,83
40	32	BNRV040V	36,58	BNRV040M	86,21
50	40	BNRV050V	42,82	BNRV050M	87,89
63	50	BNRV063V	47,97	BNRV063M	89,80

Tuerca cierre VR.
Posición 6.

d	DN	Ref. PVC-U / EPDM	€	Ref. PVC-U / FKM	€	Ref. PP-H / EPDM	€	Ref. PP-H / FKM	€
16-20	10-15	PSVR020VE	21,66	PSVR020VF	21,66	PSVR020ME	21,66	PSVR020MF	21,66
25	20	PSVR025VE	25,79	PSVR025VF	25,79	PSVR025ME	25,79	PSVR025MF	25,79
32	25	PSVR032VE	27,97	PSVR032VF	29,95	PSVR032ME	27,97	PSVR032MF	31,89
40	32	PSVR040VE	33,04	PSVR040VF	36,96	PSVR040ME	33,04	PSVR040MF	40,87
50	40	PSVR050VE	41,42	PSVR050VF	45,51	PSVR050ME	41,42	PSVR050MF	49,22
63	50	PSVR063VE	57,78	PSVR063VF	63,17	PSVR063ME	57,78	PSVR063MF	65,63

Pistón VR.
Posiciones 2-5

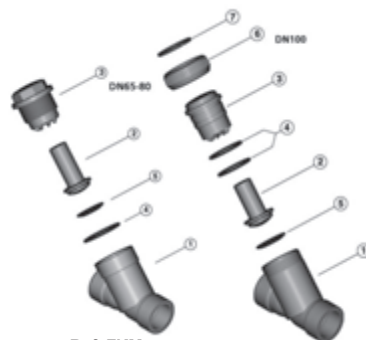

VR

Válvula anti retorno inclinada VR DN65+100

d	DN	Ref. EPDM	€	Ref. FKM	€
75	65	SETVR075E	16,91	SETVR075F	141,95
90	80	SETVR090E	20,08	SETVR090F	179,19
110	100	SETVR110E	35,83	SETVR110F	192,92

Juego de juntas VR.
Posiciones 4-5.

d	DN	Ref. PVC-U	€	Ref. PP-H	€
75	65	BOVR075V		BOVR075M	181,87
90	80	BOVR090V	210,78	BOVR090M	299,41
110	100	BOVR110V	306,41		

Porta pistón VR.

Posición 3

d	DN	Ref. PVC-U	€	Ref. PP-H	€	Rh	DN	Ref. PVC-U	€
75	65	SKBDVR075IV	167,02	SKBDVR075IM	374,90	2½"	65	TRBDVR212FV	167,02
90	80	SKBDVR090IV	217,15	SKBDVR090IM	549,89	3"	80	TRBDVR300FV	217,15
110	100	SKBDVR110IV	368,94			4"	100	TRBDVR400FV	368,94

Cuerpo H-H encolar VRI...

Posición 1.

Cuerpo H-H roscar VRFV...

Posición 1.

d	DN	Ref. PVC-U / EPDM	€	Ref. PVC-U / FKM	€	Ref. PP-H / EPDM	€	Ref. PP-H / FKM	€
75	65	PSVR075VE	136,17	PSVR075VF	165,66	PSVR075ME	179,32	PSVR075MF	217,66
90	80	PSVR090VE	149,64	PSVR090VF	251,00	PSVR090ME	249,18	PSVR090MF	357,98
110	100	PSVR110VE	199,83	PSVR110VF	335,14				

Pistón VR.

Posición 2-5.

d	DN	Ref.	€
110	100	SRRV110V	35,42

Anillo cierre VR.

Posición 7.

d	DN	Ref. PVC-U	€
110	100	BNRV110V	139,18

Tuerca cierre VR.

Posición 6.



VA

Válvula de purgabola / ventosa VA.

d	DN	Ref. EPDM	€
16-20	10-15	SETVZA020E	2,15
25	20	SETVZA025E	2,94
32	25	SETVZA032E	3,87
40	32	SETVZA040E	6,00
50	40	SETVZA050E	12,38
63	50	SETVZA063E	14,62

Juego de juntas VA-VZ.

Posiciones 5-6.

d	DN	Ref. PVC-U / EPDM	€
16-20	10-15	PSVA020VE	20,57
25	20	PSVA025VE	22,67
32	25	PSVA032VE	24,60
40	32	PSVA040VE	29,82
50	40	PSVA050VE	37,34
63	50	PSVA063VE	52,22

Pistón VA.

Posiciones 2-6.



VZ

Válvula de fondo / pie VZ.

d	DN	Ref. PVC-U	€
16-20	10-15	NTVKD020V	8,99
25	20	NTVKD025V	17,02
32	25	NTVKD032V	20,57
40	32	NTVKD040V	22,10
50	40	NTVKD050V	26,13
63	50	NTVKD063V	39,58

Tuerca unión VA-VZ.

Posición 4.

d	DN	Ref. PVC-U / EPDM	€
16-20	10-15	PSVR020VE	21,66
25	20	PSVR025VE	25,79
32	25	PSVR032VE	27,97
40	32	PSVR040VE	33,04
50	40	PSVR050VE	41,42
63	50	PSVR063VE	57,78

Pistón VZ.

Posiciones 2-6.



INDUSTRIA

Recambios Válvulas automáticas

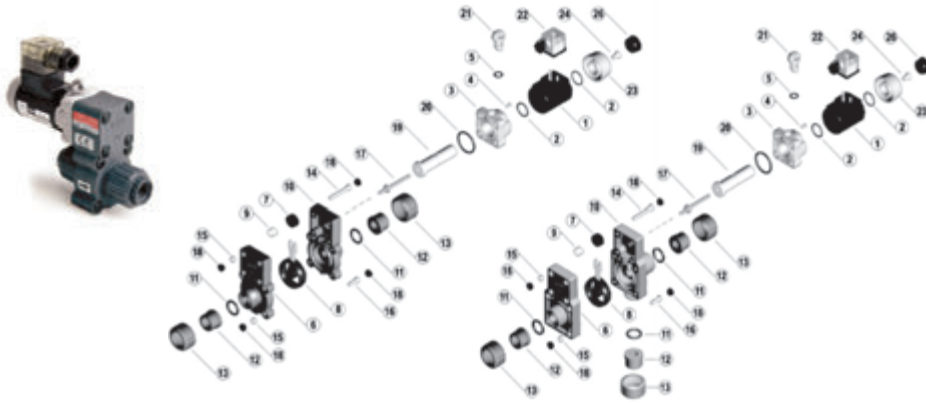

S1/S2

Válvulas de solenoide S1 y S2.

Voltaje	Ref. para válvula S1	€	Ref. para válvula S2	€
24 V DC	SLS1024VDC	111,18	SLS2024VDC	174,32
24 V AC	SLS1024VAC	111,18	SLS2024VAC	174,32
230 V AC	SLS1230VAC	111,18	SLS2230VAC	174,32

Solenoido.

Posición 1.

Voltaje	Ref.	€
24 V DC	CNS024VDC	39,04
24 V AC	CNS024VAC	39,04
110 V AV	CNS110VAC	39,04
230 V AC	CNS230VAC	39,04

Conector VA.

Posición 22.

Válvula	Ref.	€
S1	SETS1	2,18
S2	SETS2	3,03

Juego juntas secundario.

Posiciones 2-5-20.

Válvula	Ref.EPDM	€	Ref.FKM	€
S1	SHS1E	31,51	SHS1F	62,10
S2	SHS2E	34,21	SHS2F	78,76

Obturador.

Posición 8.

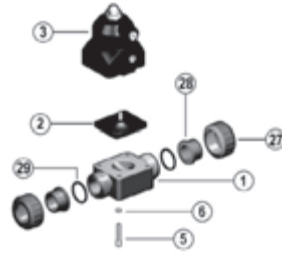

CM/CP

Válvulas de membrana compactas neumáticas CM/CP.

d	DN	DN	Ref. Normalmente cerrado NC	€	Ref. Normalmente abierto NO	€	Ref. Doble efecto DE	€
16-20	10-15	EPDM / FKM	ATCMNC	175,70	ATCMNO	175,70	ATCMDA	175,70
16-20	10-15	PTFE	ATCMNCPQ	Consultar	ATCMNOPQ	Consultar	ATCMDAPPQ	Consultar

Actuador neumático CM/CP.

Posición 3.

* Estándar en los filtros de PVC-U

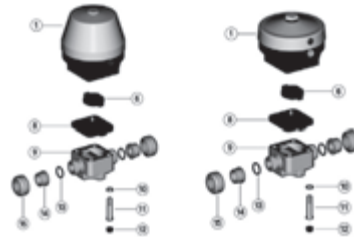

VM/CP

Válvulas de membrana neumáticas VM/CP.

d	DN	Ref. Normalmente cerrado NC	€	Ref. Normalmente abierto NO	€	Ref. Doble efecto DE	€
90	80	ATVMNC075090	1.405,92	ATVMNO075090	878,71	ATVMDA075090	1.464,53
110	100	ATVMNC110	1.812,72	ATVMNO110	1.279,03	ATVMDA110	1.464,53

Actuador neumático VM/CP.

Posiciones 1-6.

d	DN	Ref.	€
90	80	COVMMN075090	126,94
110	100	COVMMN110	136,70

Compresor VM/CP.

Posición 6.

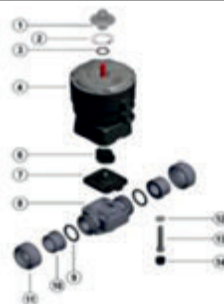

DK/CP

Válvula de membrana neumática DK/CP

d	DN	Ref. EPDM	€	Ref. FPM	€	Ref. PTFE	€	Ref. NBR	€
20	15	DIA025E	28,99	DIA025F	94,53	DIADK025P	112,35	DIA025N	28,99
25	20	DIA025E	28,99	DIA025F	94,53	DIADK025P	112,35	DIA025N	28,99
32	25	DIA032E	30,27	DIA032F	104,68	DIADK032P	128,13	DIA032N	30,27
40	32	DIA032E	30,27	DIA032F	104,68	DIADK032P	128,13	DIA032N	30,27
50	40	DIA050E	37,18	DIA050F	177,75	DIADK050P	212,22	DIA050N	37,18
63	50	DIA063E	55,13	DIA063F	253,58	DIADK063P	260,35	DIA063N	55,13
75	65	DIA063E	55,13	DIA063F	253,58	DIADIK063P	260,35	DIA063N	55,13

Membrana DK/CP. Posición 7.

d	DN	Ref.PVC-U	€	Ref.C-PVC	€	Ref.PP-H	€	Ref.PVDF	€
20	15	SPBDDK020DV	34,13	SPBDDK020DC	50,17	SPBDDK020DM	46,29	SPBDDK020DF	136,58
25	20	SPBDDK025DV	36,78	SPBDDK025DC	57,91	SPBDDK025DM	51,49	SPBDDK025DF	146,77
32	25	SPBDDK032DV	49,42	SPBDDK032DC	79,07	SPBDDK032DM	72,67	SPBDDK032DF	180,70
40	32	SPBDDK040DV	52,84	SPBDDK040DC	91,22	SPBDDK040DM	73,13	SPBDDK040DF	264,27
50	40	SPBDDK050DV	64,87	SPBDDK063DC	118,95	SPBDDK063DM	123,61	SPBDDK050DF	323,47
63	50	SPBDDK063DV	85,12	SPBDDK050DC	123,81	SPBDDK050DM	148,27	SPBDDK063DF	435,44
75	65	SPBDDK075DV	119,15	SPBDDK075DC	173,35	SPBDDK075DM	207,58	SPBDDK075DF	609,60

Cuerpo M-M DK/CP. Posición 8.

d	DN	Ref.PVC-U	€	Ref.C-PVC	€	Ref.PP-H	€	Ref.PVDF	€
20	15	UNBDDK020V	36,23	UNBDDK020C	87,05	UNBDDK020M	80,77	UNBDDK020F	144,86
25	20	UNBDDK025V	40,47	UNBDDK025C	98,49	UNBDDK025M	86,70	UNBDDK025F	161,52
32	25	UNBDDK032V	54,85	UNBDDK032C	133,29	UNBDDK032M	109,71	UNBDDK032F	200,58
40	32	UNBDDK040V	61,12	UNBDDK040C	154,44	UNBDDK040M	122,27	UNBDDK040F	295,59
50	40	UNBDDK050V	81,95	UNBDDK050C	195,11	UNBDDK050M	156,10	UNBDDK050F	339,86
63	50	UNBDDK063V	104,73	UNBDDK063C	233,63	UNBDDK063M	193,37	UNBDDK063F	460,35

Cuerpo con enlaces DKU/CP. Posición 8.

d	DN	Ref.PVC-U	€	Ref.C-PVC	€	Ref.PP-H	€	Ref.PVDF	€
20	15	FLBDDK020OV	90,54	FLBDDK020OC	153,01	FLBDDK020OM	127,51	FLBDDK020OF	314,02
25	20	FLBDDK025OV	102,36	FLBDDK025OC	179,24	FLBDDK025OM	139,53	FLBDDK025OF	329,12
32	25	FLBDDK032OV	128,29	FLBDDK032OC	212,76	FLBDDK032OM	177,23	FLBDDK032OF	381,11
40	32	FLBDDK040OV	158,78	FLBDDK040OC	261,15	FLBDDK040OM	215,37	FLBDDK040OF	604,63
50	40	FLBDDK050OV	200,20	FLBDDK050OC	315,49	FLBDDK050OM	268,67	FLBDDK050OF	677,67
63	50	FLBDDK063OV	249,00	FLBDDK063OC	392,30	FLBDDK063OM	337,67	FLBDDK063OF	872,35

Cuerpo con bridas DIN DKO/CP. Posición 8.

d	DN	Ref.PVC-U	€	Ref.C-PVC	€	Ref.PP-H	€	Ref.PVDF	€
½"	15	FLBDDK012OAV	93,88	FLBDDK012OAC	158,64	FLBDDK012OAM	132,23	FLBDDK012OAF	250,45
¾"	20	FLBDDK034OAV	106,18	FLBDDK034OAC	185,84	FLBDDK034OAM	144,70	FLBDDK034OAF	262,52
1"	25	FLBDDK100OAV	133,02	FLBDDK100OAC	220,63	FLBDDK100OAM	183,77	FLBDDK100OAF	303,94
1 ¼"	32	FLBDDK114OAV	164,62	FLBDDK114OAC	270,76	FLBDDK114OAM	223,28	FLBDDK114OAF	482,23
1 ½"	40	FLBDDK112OAV	207,60	FLBDDK112OAC	327,11	FLBDDK112OAM	278,57	FLBDDK112OAF	540,46
2"	50	FLBDDK200OAV	258,14	FLBDDK200OAC	406,74	FLBDDK200OAM	350,12	FLBDDK200OAF	695,73

Cuerpo con bridas ANSI 150 lbs DKO/CP. Posición 8.

Continúa en la página siguiente...

d	DN	Referencia	€	d	DN	Ref.NC	€	Ref.NO	€	Ref.DE	€
20	15	CODK020025	18,10	20	15	ATDKNC020025	223,52	ATDKNO020025	Consultar	ATDKDA020025	143,27
25	20	CODK020025	18,10	25	20	ATDKNC020025	223,52	ATDKNO020025	Consultar	ATDKDA020025	143,27
32	25	CODK032040	19,78	32	25	ATDKNC032040	Consultar	ATDKNO032040	Consultar	ATDKDA032040	Consultar
40	32	CODK032040	19,78	40	32	ATDKNC032040	Consultar	ATDKNO032040	Consultar	ATDKDA032040	Consultar
50	40	COVMMN040050	25,25	50	40	ATDKNC050	416,30	ATDKNO050	284,07	ATDKDA050	258,24
63	50	COVMMN063	32,77	63	50	ATDKNC063075	585,04	ATDKNO063075	367,80	ATDKDA063075	334,38
75	65	COVMMN063	32,77	75	65	ATDKNC063075	585,04	ATDKNO063075	367,80	ATDKDA063075	334,38

Compresor DK. Posición 6.

Actuador neumático DK/CP. Posiciones 1-2-3-4-6.

d	DN	Referencia	€	d	DN	Referencia	€
20	15	BSDK020025X	24,08	20+75	15+65	TCSDKCP020075	Consultar
25	20	BSDK020025X	24,08				
32	25	BSDK032040X	31,60				
40	32	BSDK032040X	31,60				
50	40	BSDK050X	39,71				
63	50	BSDK063075X	49,71				
75	65	BSDK063075X	49,71				

Tapón transparente DK. Posiciones 1-2-3.

Cierres DK. Posiciones 12-13-14.



DKB/CP

Válvulas de membrana compactas neumáticas CM/CP.

d	DN	Ref. EPDM	€
20	15	DIA025E	28,99
25	20	DIA025E	28,99
32	25	DIA032E	30,27
40	32	DIA032E	30,27
50	40	DIA050E	37,18
63	50	DIA063E	55,13
75	65	DIA063E	55,13

Membrana DKB/CP. Posición 7.

d	DN	Ref. EPDM	€
20	15	ATDKBNC020025	244,72
25	20	ATDKBNC020025	244,72
32	25	ATDKBNC032040	260,33
40	32	ATDKBNC032040	260,33
50	40	ATDKBNC050	343,56
63	50	ATDKBNC063075	481,24
75	65	ATDKBNC063075	481,24

Actuador neumático DKB/CP. Posiciones 1-6.

d	DN	Ref. PVC-U	€	Ref. C-PVC	€	Ref. PP-H	€
25	15	SPBDDK020DV	34,13	SPBDDK020DC	50,17	SPBDDK020DM	46,29
32	25	SPBDDK025DV	36,78	SPBDDK040DC	57,91	SPBDDK025DM	51,49
50	40	SPBDDK032DV	49,42	SPBDDK032DC	79,07	SPBDDK032DM	72,67
40	32	SPBDDK040DV	52,84	SPBDDK025DC	91,22	SPBDDK040DM	73,13
20	20	SPBDDK050DV	64,87	SPBDDK063DC	118,95	SPBDDK050DM	123,61
63	50	SPBDDK063DV	85,12	SPBDDK050DC	123,81	SPBDDK063DM	148,27
75	65	SPBDDK075DV	119,15	SPBDDK075DC	173,35	SPBDDK075DM	207,58

Cuerpo M-M DKB/CP. Posición 8.

d	DN	Ref. PVC-U	€	Ref. C-PVC	€	Ref. PP-H	€
20	15	UNBDDK020V	36,23	UNBDDK020C	87,05	UNBDDK020M	80,77
25	20	UNBDDK025V	40,47	UNBDDK025C	98,49	UNBDDK025M	86,70
32	25	UNBDDK032V	54,85	UNBDDK032C	133,29	UNBDDK032M	109,71
40	32	UNBDDK040V	61,12	UNBDDK040C	154,44	UNBDDK040M	122,27
50	40	UNBDDK050V	81,95	UNBDDK050C	195,11	UNBDDK050M	156,10
63	50	UNBDDK063V	104,73	UNBDDK063C	233,63	UNBDDK063M	193,37

Cuerpo con enlaces DKBU/CP. Posición 8.

d	DN	Ref. PVC-U	€	Ref. C-PVC	€	Ref. PP-H	€
20	15	FLBDDK020OV	90,54	FLBDDK020OC	153,01	FLBDDK020OM	127,51
25	20	FLBDDK025OV	102,36	FLBDDK025OC	179,24	FLBDDK032OM	139,53
32	25	FLBDDK032OV	128,29	FLBDDK032OC	212,76	FLBDDK025OM	177,23
40	32	FLBDDK040OV	158,78	FLBDDK040OC	261,15	FLBDDK050OM	215,37
50	40	FLBDDK050OV	200,20	FLBDDK050OC	315,49	FLBDDK040OM	268,67
63	50	FLBDDK063OV	249,00	FLBDDK063OC	392,30	FLBDDK063OM	337,67

Cuerpo con bridas DIN DKBO/CP. Posición 8.

d	DN	Ref. PVC-U	€	Ref. C-PVC	€	Ref. PP-H	€
½"	15	FLBDDK012OAV	93,88	FLBDDK012OAC	158,64	FLBDDK012OAM	132,23
¾"	20	FLBDDK034OAV	106,18	FLBDDK034OAC	185,84	FLBDDK034OAM	144,70
1"	25	FLBDDK100OAV	133,02	FLBDDK100OAC	220,63	FLBDDK100OAM	183,77
1 ¼"	32	FLBDDK114OAV	164,62	FLBDDK114OAC	270,76	FLBDDK114OAM	223,28
1 ½"	40	FLBDDK112OAV	207,60	FLBDDK112OAC	327,11	FLBDDK112OAM	278,57
2"	50	FLBDDK200OAV	258,14	FLBDDK200OAC	406,74	FLBDDK200OAM	350,12

Cuerpo con bridas ANSI 150 lbs DKBO/CP. Posición 8.

d	DN	Ref. EPDM	€
20	15	BSDK020025X	24,08
25	20	BSDK020025X	24,08
32	25	BSDK032040X	31,60
40	32	BSDK032040X	31,60
50	40	BSDK050X	39,71
63	50	BSDK063075X	49,71
75	65	BSDK063075X	49,71

Mcierres DKB. Posición 12-13-14.

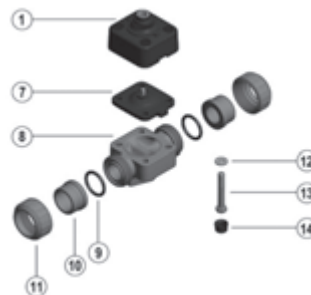

DKD/CP

Válvulas de membrana neumática DKD/CP.

d	DN	Ref. EPDM	€
20	15	DIADKD025E	Consultar
25	20	DIADKD025E	Consultar
32	25	DIA032E	30,27
40	32	DIA032E	30,27
50	40	DIA050E	37,18
63	50	DIA063E	55,13
75	65	DIA063E	55,13

Membrana DKD / CP. Posición 7.

d	DN	Ref. PVC-U	€
20	15	SPBDDK020DV	34,13
25	20	SPBDDK025DV	36,78
32	25	SPBDDK032DV	49,42
40	32	SPBDDK040DV	52,84
50	40	SPBDDK050DV	64,87
63	50	SPBDDK063DV	85,12
75	65	SPBDDK075DV	119,15

Cuerpo DKDD...
 Posición 8.

M-M encolar

d	DN	Ref. PVC-U	€
20	15	UNBDDK020V	36,23
25	20	UNBDDK025V	40,47
32	25	UNBDDK032V	54,85
40	32	UNBDDK040V	61,12
50	40	UNBDDK050V	81,95
63	50	UNBDDK063V	104,73

Cuerpo DKDU...
 Posición 8.

H-H encolar con enlaces

d	DN	Ref.	€
20÷25	15÷20	BODKD020025	32,42
32÷40	25÷32	BODKD032040	34,54
50	40	BODKD050	57,50
63÷75	50÷65	BODKD063075	83,67

Cubierta DKD/CP.
 Posición 1.

d	DN	Ref.	€
20÷25	15÷20	BSDK020025X	24,08
32÷40	25÷32	BSVM020032X	33,18
50	40	BSVM040050X	39,04
63÷75	50÷65	BSVM063X	48,90

Cierres DKD/CP.
 Posiciones 12-13-14.



INDUSTRIA

Recambios Uniones 3 piezas



Parte LOCA



Parte FIJA



TUERCA



PVC-U



PP-H



C-PVC



PVDF

Bl...

Uniones 3 piezas en PVC-U.

d	Ref.	€
16	QBIV016	0,63
20	QBIV020	0,63
25	QBIV025	0,64
32	QBIV032	0,81
40	QBIV040	0,92
50	QBIV050	1,28
63	QBIV063	1,69
75	QBIV075	4,02
90	QBIV090	5,11
110	QBIV110	9,94

Parte loca. *H encolar.*

d	Ref.	€
16	FBIV016	0,81
20	FBIV020	0,81
25	FBIV025	0,97
32	FBIV032	1,39
40	FBIV040	1,64
50	FBIV050	2,23
63	FBIV063	3,31
75	FBIV075	9,20
90	FBIV090	11,86
110	FBIV110	17,57

Parte fija. *H encolar.*

d	Ref.	€
16	EFV034	1,49
20	EFV100	1,99
25	EFV114	2,32
32	EFV112	2,50
40	EFV200	2,91
50	EFV214	2,51
63	EFV234	4,52
75	EFV312	18,97
90	EFV400	26,31
110	EFV500	34,54

Tuerca. *H rosacar.*

Rh	Ref.	€
3/8"	QBFV038	4,01
1/2"	QBFV012	4,01
3/4"	QBFV034	4,72
1"	QBFV100	8,69
1 1/4"	QBFV114	9,06
1 1/2"	QBFV112	10,64
2"	QBFV200	14,01

Parte loca. *H rosacar.*

Rh	Ref.	€
3/8"	FBFV038	4,29
1/2"	FBFV012	5,21
3/4"	FBFV034	5,83
1"	FBFV100	7,81
1 1/4"	FBFV114	9,54
1 1/2"	FBFV112	13,83
2"	FBFV200	17,97

Parte fija. *H rosacar.*

Uniones 3 piezas en PP-H.

d	Ref.	€
20	QBIGM020	3,81
25	QBIGM025	3,87
32	QBIGM032	4,13
40	QBIGM040	5,11
50	QBIGM050	6,11
63	QBIGM063	6,50

Parte loca. *H soldar.*

d	Ref.	€
20	FBIGM020	7,43
25	FBIGM025	8,17
32	FBIGM032	9,34
40	FBIGM040	12,20
50	FBIGM050	17,31
63	FBIGM063	23,01

Parte fija. *H soldar.*

d	Ref.	€
20	EFGM100	7,28
25	EFGM114	7,54
32	EFGM112	8,75
40	EFGM200	11,17
50	EFGM214	17,30
63	EFGM234	27,89

Tuerca. *H rosacar.*

Continúa en la página siguiente...



Uniones 3 piezas en C-PVC.

d	Ref.	€
16	QBIC016	9,01
20	QBIC020	8,95
25	QBIC025	10,47
32	QBIC032	13,61
40	QBIC040	16,69
50	QBIC050	22,22
63	QBIC063	29,66

d	Ref.	€
16	FBIC016	7,46
20	FBIC020	7,56
25	FBIC025	8,67
32	FBIC032	12,68
40	FBIC040	16,23
50	FBIC050	21,43
63	FBIC063	25,54

d	Ref.	€
16	EFC034	7,18
20	EFC100	8,01
25	EFC114	9,27
32	EFC112	13,44
40	EFC200	15,29
50	EFC214	25,05
63	EFC234	35,72

Parte loca. *H encolar.*

Parte fija. *H encolar.*

Tuerca. *H roscar.*

Rh	Ref.	€
3/8"	QBFC038	Consultar
1/2"	QBFC012	15,23
3/4"	QBFC034	16,91
1"	QBFC100	19,88
1 1/4"	QBFC114	23,28
1 1/2"	QBFC112	26,29
2"	QBFC200	35,59

Rh	Ref.	€
3/8"	FBFC038	8,58
1/2"	FBFC012	10,29
3/4"	FBFC034	11,73
1"	FBFC100	15,77
1 1/4"	FBFC114	18,61
1 1/2"	FBFC112	25,79
2"	FBFC200	35,80

Parte loca. *H roscar.*

Parte fija. *H roscar.*

Uniones 3 piezas en PVDF.

d	Ref.	€
20	QBIGF020	14,80
25	QBIGF025	19,15
32	QBIGF032	21,33
40	QBIGF040	27,22
50	QBIGF050	31,01
63	QBIGF063	43,01

d	Ref.	€
20	FBIGF020	21,95
25	FBIGF025	28,72
32	FBIGF032	31,63
40	FBIGF040	40,70
50	FBIGF050	54,91
63	FBIGF063	86,07

d	Ref.	€
20	EFGF100	24,39
25	EFGF114	33,29
32	EFGF112	41,28
40	EFGF200	56,75
50	EFGF214	82,76
63	EFGF234	128,69

Parte loca. *H soldar.*

Parte fija. *H soldar.*

Tuerca. *H roscar.*

Juntas para uniones 3 piezas



d	Ref.	€
16	OR3062E	1,77
20	OR4081E	5,04
25	OR4112E	1,81
32	OR4131E	2,57
40	OR6162E	2,74
50	OR6187E	2,91
63	OR6237E	3,18
75	OR6300E	6,37
90	OR6362E	9,53
110	OR6450E	12,58

d	Ref.	€
16	OR3062F	4,35
20	OR4081F	13,34
25	OR4112F	2,51
32	OR4131F	7,10
40	OR6162F	10,47
50	OR6187F	11,93
63	OR6237F	13,34
75	OR6300F	24,97
90	OR0185F	27,37
110	OR6450F	45,50

Junta tórica. *En EPDM.*

Junta tórica. *En FKM.*



FC/FS

Flujómetros cortos (FC) y largos (FS).

d	DN	Ref. SS para líquidos	€	Ref. SS + M para líquidos	€	Ref. PP para líquidos	€	Ref. PP + M para líquidos	€
16	10	FL016X	37,55	FL016XM	116,04	FL016M	37,55	FL016MM	116,04
20	15	FL020X	40,93	FL020XM	133,10	FL020M	40,93	FL020MM	133,10
25	20	FL025X	46,09	FL025XM	138,21	FL025M	46,07	FL025MM	138,21
32	25	FL032X	51,19	FL032XM	170,61	FL032M	51,19	FL032MM	170,61
40	32	FL040X	95,56	FL040XM	221,81	FL040M	95,56	FL040MM	221,81
50	40	FL050X	119,45	FL050XM	255,93	FL050M	119,45	FL050MM	255,93
63	50	FL063X	187,68	FL063XM	341,26	FL063M	187,68	FL063MM	341,26
75	65	FL075X	385,60	FL075XM	720,03	FL075M	385,60	FL075MM	720,03
75 cuerpo 68	65	FL07568X	385,60	FL07568XM	720,03	FL07568M	385,60	FL07568MM	720,03

d	DN	Ref. PP para gases	€	Ref. PP + M para gases	€
16	10	FL016GM	37,55	FL016GMM	116,04
20	15	FL020GM	40,93	FL020GMM	133,10
25	20	FL025GM	46,09	FL025GMM	138,21
32	25	FL032GM	51,19	FL032GMM	170,61
40	32	FL040GM	95,56	FL040GMM	221,81
50	40	FL050GM	119,45	FL050GMM	255,93
63	50	FL063GM	187,68	FL063GMM	341,26
75	65	FL075GM	385,60	FL075GMM	720,03

Flotador FC y FS. Posición 8.

d	DN	Ref. Serie FC	€	Ref. Serie FS	€
16	10	STFC016P	23,06		
20	15	STFC020P	23,06		
25	20	STFC025P	23,92	STFS025P	23,92
32	25	STFC032P	26,19	STFS032P	26,19
40	32			STFS040P	37,72
50	40			STFS050P	41,21
63	50			STFS063P	51,45
75	65			STFS075PINF	97,57
75 cuerpo 68	65			STFS075PSUP	97,57

Topes flotador FC y FS. Posición 7.

Se necesita 1 pieza para la serie FC y 2 piezas para la serie FS (precio por unidad)

Continúa en la página siguiente...

Ref.	Descripción	€
VFI01	Indicadores visuales para FS y FC d 32 (2 piezas)	3,40
VFI02	Indicadores visuales para FC 16, 20 y d 25 (2 piezas)	3,40

Indicadores visuales de caudal FC y FS.
 Posición 2.



d	Ref.	€
16	OR3062E	1,77
20	OR4081E	5,04
25	OR4112E	1,81
32	OR4131E	2,57
40	OR0150E	3,68
50	OR4200E	3,25
63	OR4275E	5,06
75	OR6325E	8,20

Junta tórica en EPDM.
 Posición 6.



d	Ref.	€
16	OR3062F	4,35
20	OR4081F	13,34
25	OR4112F	2,51
32	OR4131F	7,10
40	OR0150F	13,97
50	OR4200F	10,90
63	OR4275F	17,34
75	OR6325F	27,83

Junta tórica en FKM.
 Posición 6.

AENOR
Confía



Certificado del Sistema de Gestión de la Calidad



ER-0288/1996

AENOR certifica que la organización

ALIAxis IBERIA, S.A.U.

dispone de un sistema de gestión de la calidad conforme con la Norma ISO 9001:2015

para las actividades: A) La producción de tuberías de polietileno entre 20 mm. y 1000 mm. de diámetro. La producción de Push-Fast y accesorios manipulados para tuberías de polietileno. La comercialización de tubos, accesorios para tubería y valvulería.
B) Comercialización y postventa de máquinas electrosoldables y de herramientas relacionados con la electrosoldadura.

que se realizan en: A) PI ZUDIBIARTE, S/N - PABELLONES A y C. 01409 - OKONDO (ARABA/ALAVA)
B) ANABEL SEGURA 11, EDIFICIO A 1º 3. 28108 - MADRID
C) CL SALAS BARRADILLO, 12 LOCAL E. 28017 - MADRID

Fecha de primera emisión: 1996-06-24
Fecha de última emisión: 2023-10-07
Fecha de expiración: 2024-10-07

Rafael GARCÍA MEIRO
Director General

AENOR INTERNACIONALS S.A.U.
Gervósia 6, 28004 Madrid, España
Tel. ES 432 50 00 - www.aenor.com



CERTIFICATE

AENOR has issued an IQNet recognized certificate that the organization:

ALIAxis IBERIA, S.A.U.

A) PI ZUDIBIARTE, S/N - PABELLONES A y C. 01409 - OKONDO (ARABA/ALAVA)
B) ANABEL SEGURA 11, EDIFICIO A 1º 3. 28108 - MADRID
C) CL SALAS BARRADILLO, 12 LOCAL E. 28017 - MADRID

has implemented and maintains a
Quality Management System

for the following scope:

**A) Production of polyethylene pipes diameters from 20 mm. up to 1000 mm. Production of Push-Fast and fabricated fittings for PE pipes.
Bought in pipes, fittings and valves activity.**
B) Trading and after-sales service of electrofusion machines and other electrofusion related toolings.

which fulfills the requirements of the following standard

ISO 9001:2015

First issued on: 1999-08-01 Last issued: 2021-10-07 Validity date: 2024-10-07

This attestation is directly linked to the IQNet Partner's original certificate and shall not be used as a stand-alone document

Registration Number: ES-0288/1996



Alex Stoichitov
President of IQNet

Rafael GARCÍA MEIRO
Chief Executive Officer

AENOR

IQNet Partners*

AENOR Spain AFNOR Certification France ANPCER Portugal CCC Cyprus CISO Italy CQC China CQM China CQS Czech Republic Cve Cert Croatia DQS Holding GmbH Germany EAGLE Certification Group USA FCVY Brazil FONDONORMA Venezuela IBCONTEC Colombia Inspectorii Serbitutiari Oy Finland INTECO Costa Rica IRAM Argentina JQA Japan KPO Korea MIRTEC Greece MSZT Hungary Nemko AS Norway NSAI Ireland NYCE-SIGE Mexico PCBK Poland Quality Austria Austria RR Russia SII Israel SIQ Slovenia SIRIM QAS International Malaysia SQS Switzerland SRAC Romania TEST St Petersburg Russia TSE Turkey YUQS Serbia

* The list of IQNet partners is valid at the time of issue of this certificate. Updated information is available under www.iqnet-certification.com

AENOR

Certificado del Sistema de Gestión Ambiental



GA-2005/0349

AENOR certifica que la organización

ALIAxis IBERIA, S.A.U.

dispone de un sistema de gestión ambiental conforme con la Norma ISO 14001:2015

para las actividades: La producción de tuberías de polietileno entre 20 mm. y 1000 mm. de diámetro. La producción de Push-Fast y accesorios manipulados para tuberías de polietileno. La comercialización de tubos, accesorios para tubería y valvulería.

que se realizan en: PI ZUDIBIARTE, S/N - PABELLONES A y C. 01409 - OKONDO (ARABA/ALAVA)

Fecha de primera emisión: 2005-08-02
Fecha de última emisión: 2023-08-02
Fecha de expiración: 2023-08-02

Rafael GARCÍA MEIRO
Director General

AENOR INTERNACIONALS S.A.U.
Gervósia 6, 28004 Madrid, España
Tel. ES 432 60 00 - www.aenor.com



CERTIFICATE

AENOR has issued an IQNet recognized certificate that the organization:

ALIAxis IBERIA, S.A.U.

PI ZUDIBIARTE, S/N - PABELLONES A y C. 01409 - OKONDO (ARABA/ALAVA)

has implemented and maintains a
Environmental Management System

for the following scope:

**Production of polyethylene pipes diameters from 20 mm. up to 1000 mm. Production of Push-Fast and fabricated fittings for PE pipes.
Bought in pipes, fittings and valves activity.**

which fulfills the requirements of the following standard

ISO 14001:2015

First issued on: 2005-08-02 Last issued: 2020-08-02 Validity date: 2023-08-02

This attestation is directly linked to the IQNet Partner's original certificate and shall not be used as a stand-alone document

Registration Number: ES-2005/0349



Alex Stoichitov
President of IQNet

Rafael GARCÍA MEIRO
Chief Executive Officer

AENOR

IQNet Partners*

AENOR Spain AFNOR Certification France ANPCER Portugal CCC Cyprus CISO Italy CQC China CQM China CQS Czech Republic Cve Cert Croatia DQS Holding GmbH Germany EAGLE Certification Group USA FCVY Brazil FONDONORMA Venezuela IBCONTEC Colombia Inspectorii Serbitutiari Oy Finland INTECO Costa Rica IRAM Argentina JQA Japan KPO Korea MIRTEC Greece MSZT Hungary Nemko AS Norway NSAI Ireland NYCE-SIGE Mexico PCBK Poland Quality Austria Austria RR Russia SII Israel SIQ Slovenia SIRIM QAS International Malaysia SQS Switzerland SRAC Romania TEST St Petersburg Russia TSE Turkey YUQS Serbia

* The list of IQNet partners is valid at the time of issue of this certificate. Updated information is available under www.iqnet-certification.com

NOTA: Los datos facilitados en este catálogo, como consecuencia de la constante mejora y evolución de nuestros productos, pueden variar sin previo aviso.

Este catálogo no tiene carácter contractual, y toda la información se da de buena fe.

Declinamos cualquier responsabilidad derivada de la aplicación de los mismos.

La versión más actualizada de este catálogo la encontrará disponible en nuestra página web.

Normas Generales

PRECIOS: Los precios son de VENTA AL PÚBLICO (Recomendados) y pueden ser modificados sin previo aviso. Los precios no incluyen IVA.

EXPEDICIONES Y PEDIDOS: El importe mínimo de pedido es de 300€. La mercancía viaja siempre por cuenta y riesgo del comprador. Los pedidos serán siempre de cajas o camiones completos, en función de la naturaleza del producto y acuerdos comerciales. Las unidades mínimas de venta recogidas en la presente tarifa son de obligado cumplimiento, así como la venta por múltiplos de esta, conforme a los acuerdos comerciales en vigor. En caso que ALIAXIS IBERIA S.A.U. autorice enviar unidades sueltas, tendrán un recargo del 20% en concepto de manipulación.

PORTES: Los pedidos superiores a 600€, dentro de la Península disfrutarán de portes gratuitos. En el caso de Canarias los pedidos superiores a 1.500€ estarán igualmente exentos de cargo de portes.

Puede consultar los cargos por portes en el siguiente link: www.aliaxis.es/condicionescomerciales.

ALIAXIS IBERIA S.A.U. gestionará los envíos a las direcciones correspondientes al domicilio habitual del comprador. En caso, de necesitar un envío a la dirección de un tercero, se aplicará el correspondiente cargo por portes a terceros. Este importe puede consultarse en el siguiente enlace: www.aliaxis.es/condicionescomerciales

ANULACIONES DE PEDIDOS: No se admiten anulaciones de pedidos que ya estén fabricados, en curso de fabricación o sobre los que ya se haya emitido albarán para su envío y por tanto estén en transporte.

DEVOLUCIONES DE MATERIAL: No se admiten devoluciones de material, salvo por defecto imputable a la fabricación o a la gestión del transporte, en este último caso el comprador deberá inspeccionar las mercancías de forma inmediata tras su recepción. Cualquier desperfecto reconocible en el transcurso de la inspección rutinaria y que sea asumible por el transporte, deberá notificarse a ALIAXIS IBERIA S.A.U. por email en un plazo máximo de 3 días laborables tras su recepción, no pudiendo ser atendidas las reclamaciones que excedan ese periodo.

CONDICIONES DE ENTREGA: Los pedidos podrán ser suministrados y facturados en parte sin que ello suponga la anulación de los mismos.

CALIDAD Y GARANTÍA: La garantía de nuestros materiales queda limitada a la reposición del producto, modelo o pieza que sea reconocida como defectuosa. Igualmente cubre todos los daños a terceros mediante póliza de responsabilidad civil, siempre y cuando se hayan observado las especificaciones y prescripciones para su uso correcto e instalación descritas en la documentación técnica del producto. Dado las características de los materiales cualquier reclamación de calidad, deberá plantearse dentro de los 15 días naturales siguientes a la entrega del material. Cualquier utilización o uso de nuestros materiales para fines distintos a los que fueron fabricados eximirá de cualquier tipo de responsabilidad.

PAGOS: Los precios de la tarifa están considerados para pagos al contado. No obstante, previa clasificación del comprador, se podrá optar a otras condiciones de mercado en el marco de las normas vigentes, entre ellas la Ley 15/2010 de medidas contra la morosidad en las operaciones comerciales. Los pagares y cheques tan solo se consideran aceptados por ALIAXIS IBERIA S.A.U. en el momento en el que se hagan efectivos, no constituyendo en ningún caso la entrega de los mismos el cumplimiento de la obligación correspondiente.

Anexo 1: En caso de que la mora, la insolvencia o las deudas por parte del comprador hagan peligrar la solvencia de ALIAXIS IBERIA S.A.U. estará facultada para exigir de forma inmediata la liquidación de todas las cantidades adeudadas o la provisión de garantías, tanto en ese momento como en futuros. ALIAXIS IBERIA S.A.U. podrá realizar únicamente las entregas pendientes en caso de que estas se hayan abonado por adelantado o se hayan presentado las garantías suficientes. En caso de que el comprador no pueda cumplir lo anterior en un período razonable de tiempo ALIAXIS IBERIA S.A.U. podrá rescindir el contrato de venta.

COMERCIALIZACIÓN: El comprador se compromete a no vender, transferir, transbordar o disponer de ninguna otra manera de los Productos (i) a individuos y/o entidades objeto de sanciones financieras o económicas; y/o (ii) con conocimiento o razón para creer que el comprador y/o usuario final puede utilizar los productos para cualquier uso final prohibido (como en relación con armas nucleares, químicas o biológicas o misiles, cualquier otro uso final militar en un país sujeto a un embargo de armas o como piezas para artículos militares). Además, el comprador se compromete a proporcionar a ALIAXIS IBERIA S.A.U. cualquier información necesaria para cumplir con las leyes y regulaciones de control y/o sanciones de exportación.

RESERVA DE PROPIEDAD: ALIAXIS IBERIA S.A.U. conservará la propiedad de las mercancías suministradas hasta que se abone el pago total del correspondiente precio de compra y se liquiden la totalidad de las deudas pendientes por parte del comprador a ALIAXIS IBERIA S.A.U. En los casos especificados en el Anexo 1, ALIAXIS IBERIA S.A.U. también podrá impedir la tramitación y la reventa de la mercancía entregada con efectos inmediatos. Una declaración de rescisión del contrato por parte de ALIAXIS IBERIA S.A.U. también se considerará una anulación de la autorización para revender y cobrar los derechos de reventa. En estos, caso ALIAXIS IBERIA S.A.U. también podrá exigir la devolución inmediata de las mercancías entregadas por cuenta del comprador.

PROHIBICIÓN DE CESIÓN: El comprador tan solo podrá ceder los derechos y las deudas dimanantes de contratos de venta a terceros con el consentimiento previo de ALIAXIS IBERIA S.A.U.

RESERVA: Nos reservamos el derecho a introducir modificaciones de diseño, medidas y unidades de embalaje en nuestros fabricados sin previo aviso.

COMPETENCIA JUDICIAL: Para resolver las cuestiones que puedan derivarse de la aplicación de estas Normas, tanto ALIAXIS IBERIA S.A.U. como comprador, convienen someterse a los Juzgados y Tribunales pertinentes renunciando a su propio fuero si fuese otro.

LIMITACIONES: Queda prohibida la reproducción total o parcial de esta tarifa sin la autorización expresa de ALIAXIS IBERIA S.A.U. Esta tarifa está sujeta a modificación sin previo aviso, todos los datos y especificaciones técnicas expresadas, se dan de buena fe y no tienen carácter contractual. Declinamos cualquier responsabilidad derivada de la aplicación de los mismos.

Somos la fuerza de todas nuestras marcas locales y un equipo global



Aliaxis Iberia, S.A.U.

C/ del Yen, s/n - Pol. Las Atalayas
03114 Alicante, España
+34 965 109 044

alixis.es

Empresa registrada según normas



Contacta con uno
de nuestros expertos
o consulta nuestra tarifa:

