

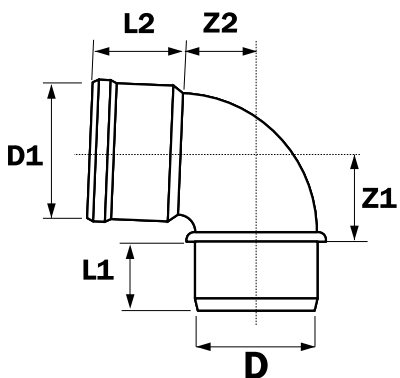

Referencia	Medidas	Características	u./caja
33040571	40-28/32	-	90
33040572	50-28/40	-	40

Cotas

Referencia	D	D1	Z1	Z2	L1	L2
33040571	40	28/32	21	21	27	27
33040572	50	28/40	29	30	37	35



Documentación



Certificados



Tarifas

